

COOL'2017

18-22 September 2017

Gustav-Stresemann-Institut, Bonn

The NICA Project: Three Stages and Three Coolers

I.Meshkov, G.Trubnikov for NICA Team



Three stages of the NICA project: status and tasks

Outline

Introduction: NICA project goals

1. Stage I: Experiment “The Baryonic Matter at Nuclotron”
2. Stage II : Search for The Mixed Phase and New Physics In Heavy Ions’ Collisions at NICA Collider
3. Stage II-a: The basic configuration of the NICA complex
 - 3.1. Status of The NICA civil construction (11.05.2017)
4. Stage II-b: The project (full) configuration of the NICA complex
5. Stage III: Polarized Beams’ Mode of The Collider
6. NICA Milestones
7. Instead Summary: NICA Megaproject

Introduction: NICA project goals

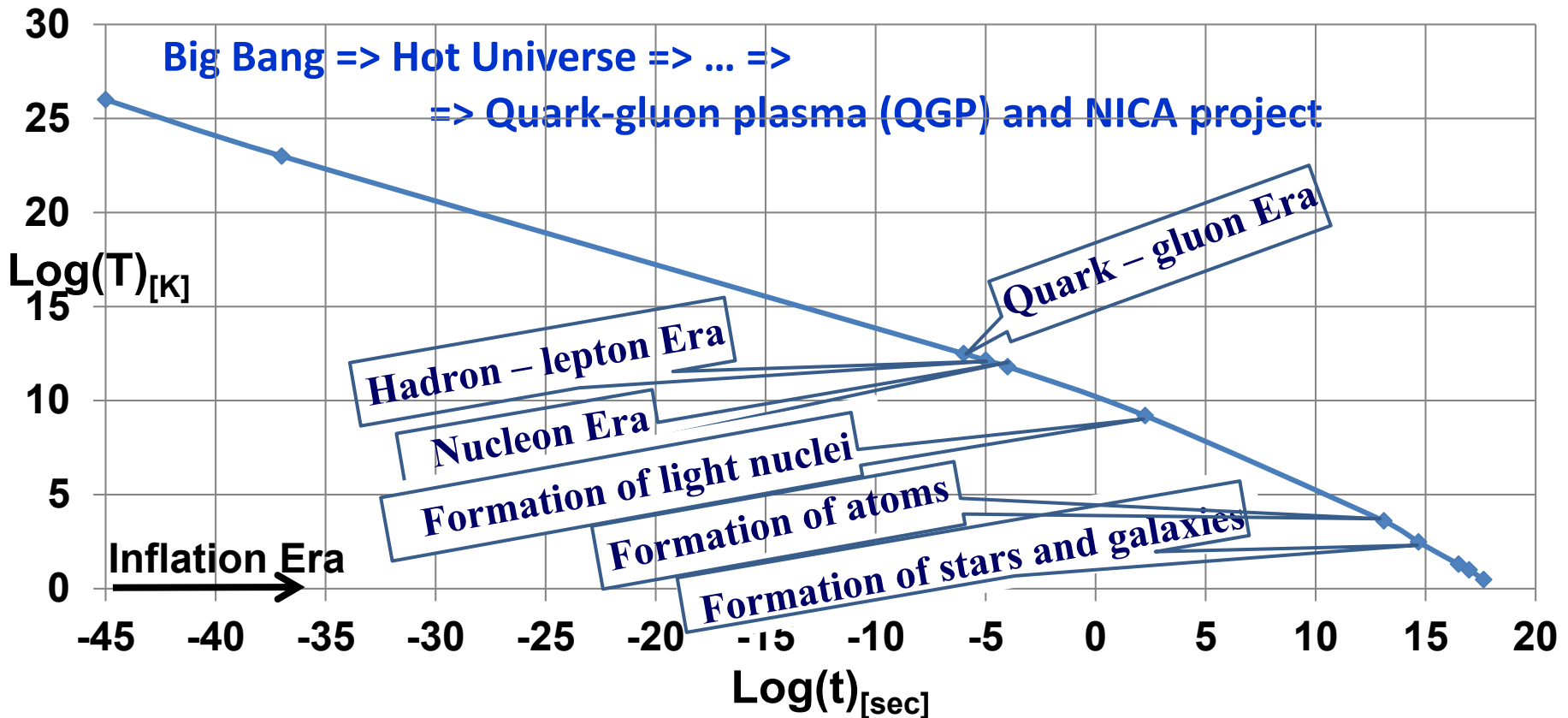

Planck Era

Gravitation force

GUT force

Strong (Nuclear) Force

Electroweak force

Electromagnetic Force
Weak Force

Grand Unification Theory (GUT)



Introduction: NICA project goals

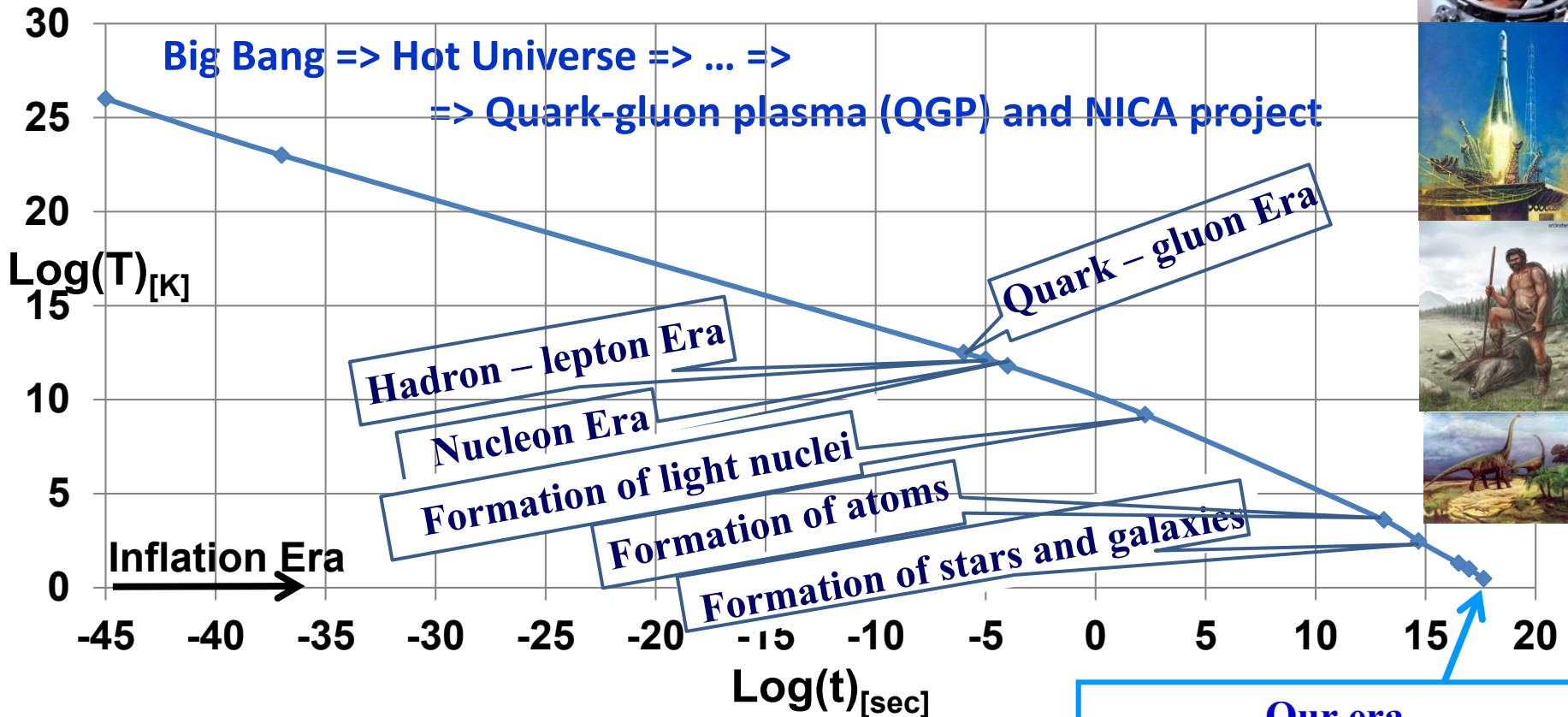

Planck Era

Gravitation force

GUT force

Strong (Nuclear) Force

Electroweak force

Electromagnetic Force
Weak Force

Grand Unification Theory (GUT)



Introduction: NICA project goals

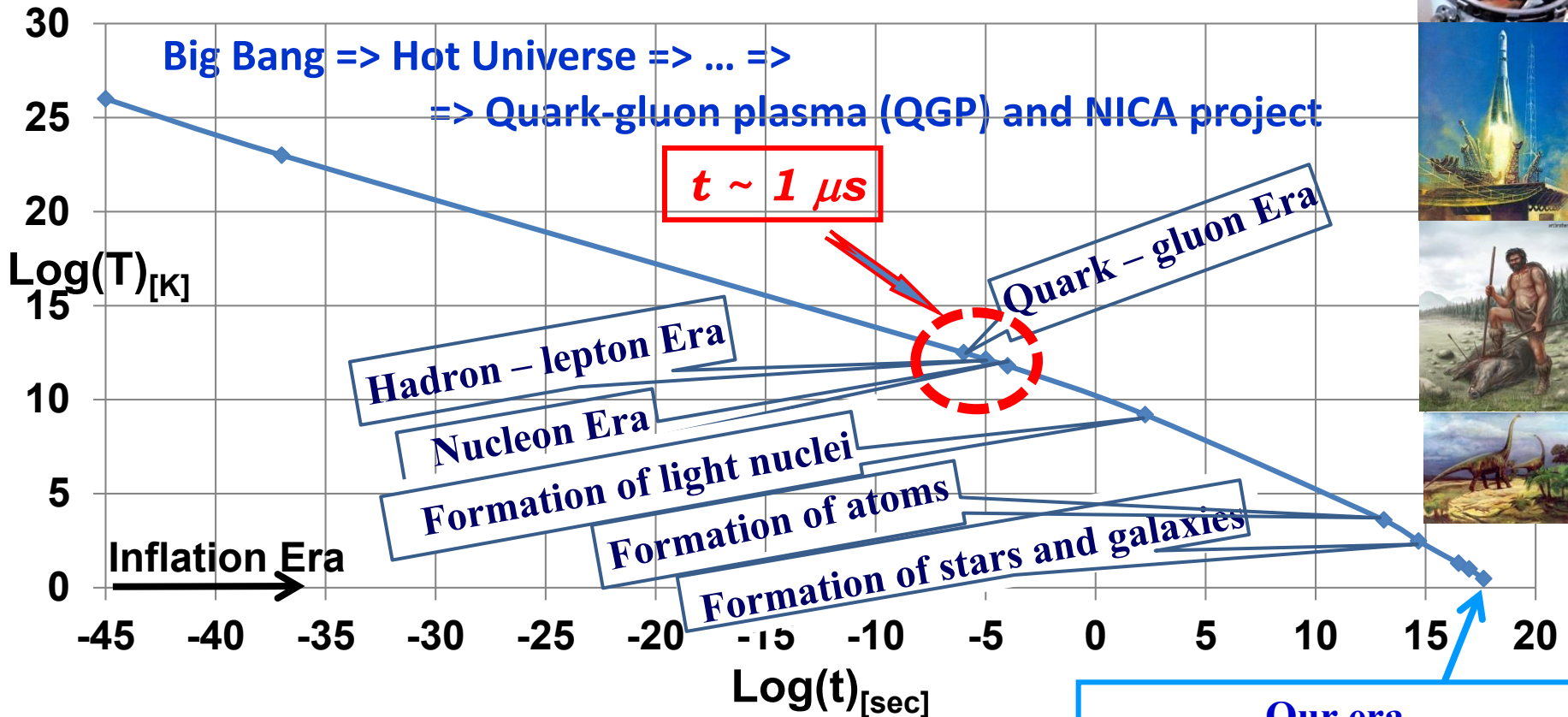

Our era
 13.798 ± 0.037 billion years
 (Planck Mission data, 2013)

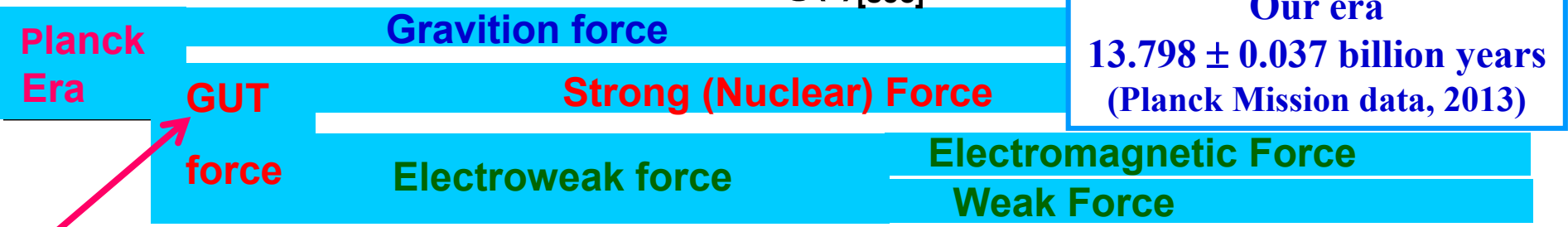

Grand Unification Theory (GUT)



Введение: физика плотной барионной материи и проект NICA

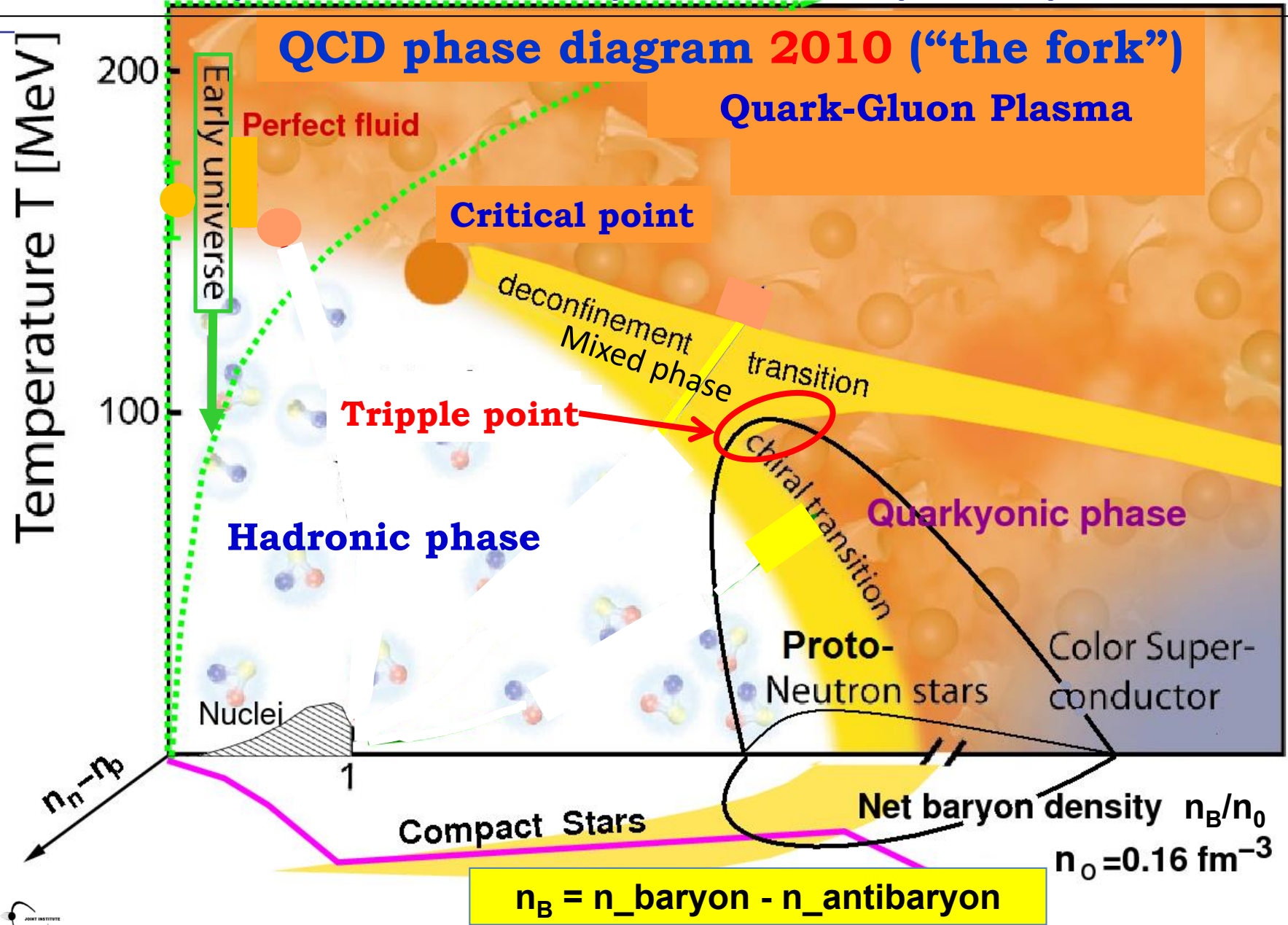

Nuclei Collision and Phase Trajectories in $T-n_B$ space

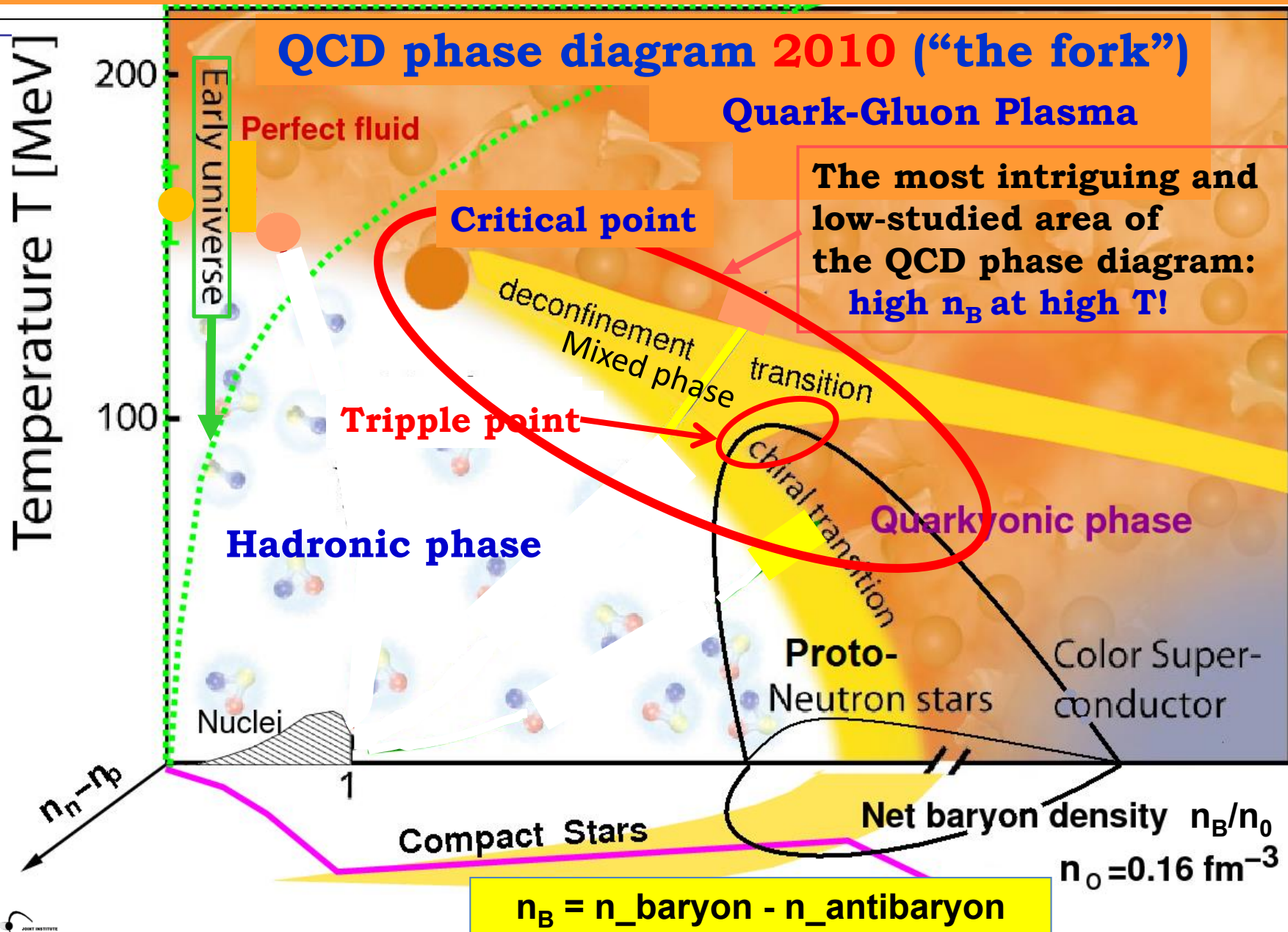

Nuclei Collision and Phase Trajectories in $T-n_B$ space

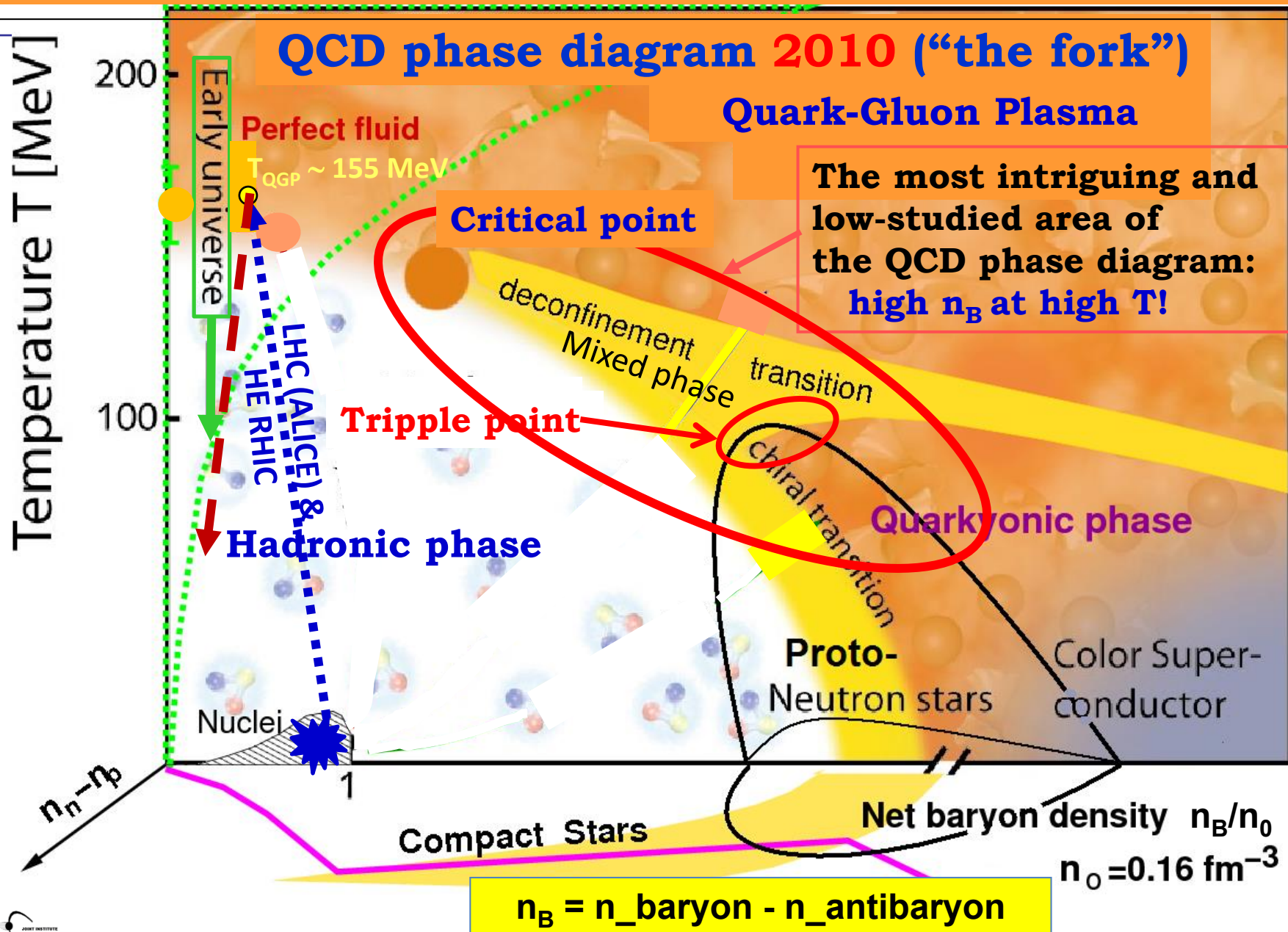

Nuclei Collision and Phase Trajectories in $T-n_B$ space

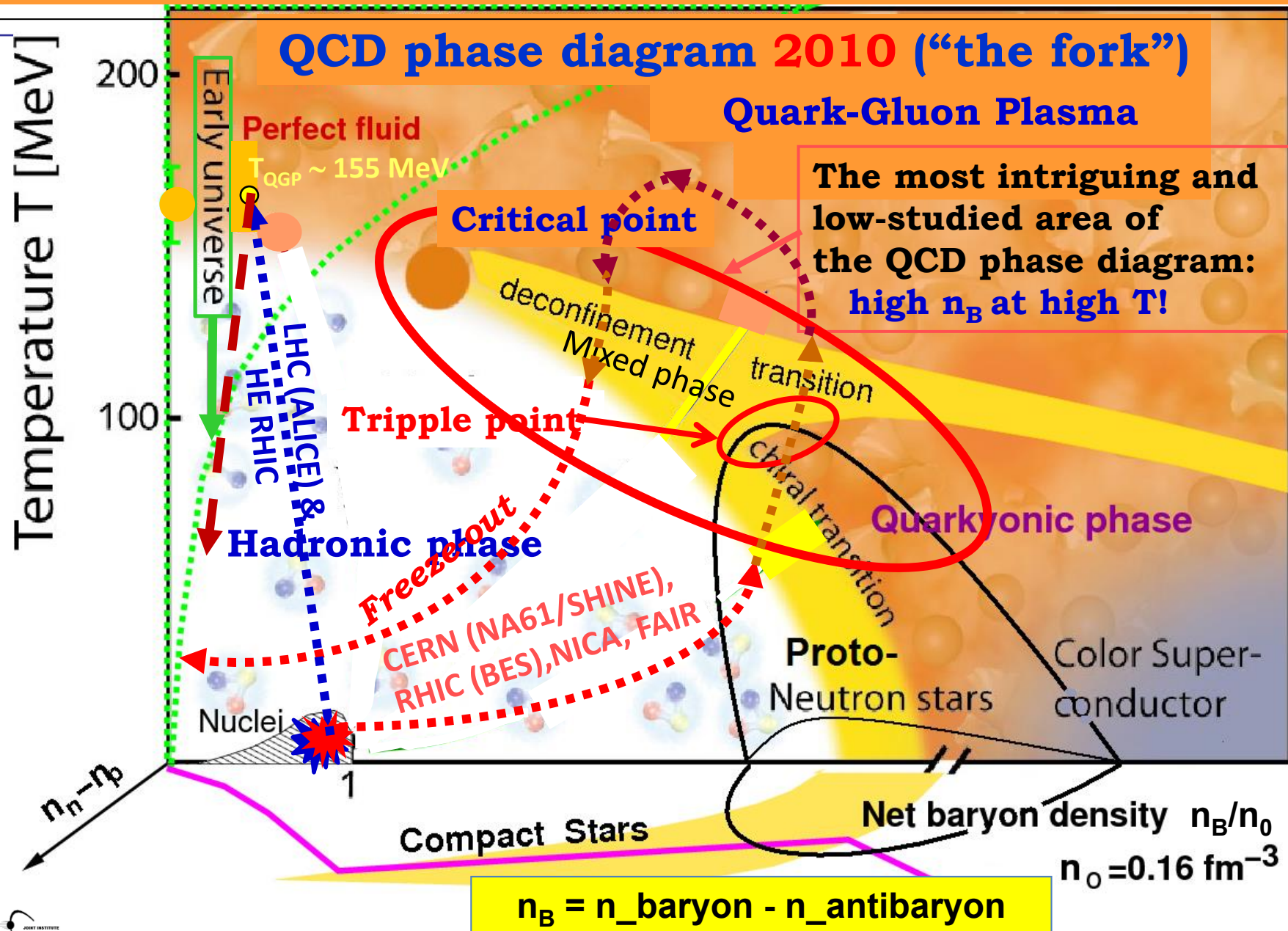

NICA Stage I: Experiment “The Baryonic Matter at Nuclotron”

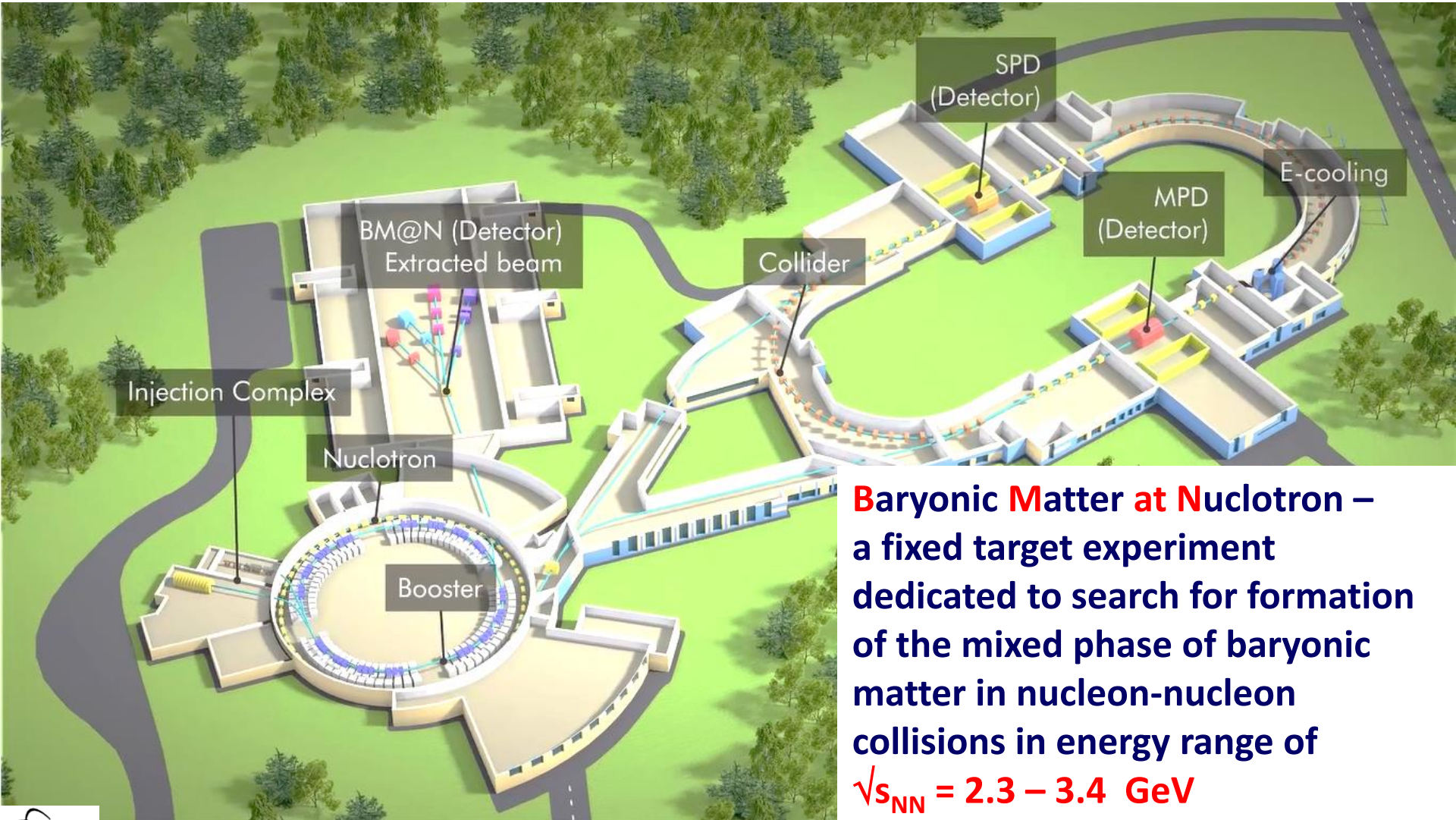

Baryonic Matter at Nuclotron –
a fixed target experiment
dedicated to search for formation
of the mixed phase of baryonic
matter in nucleon-nucleon
collisions in energy range of
 $\sqrt{s_{NN}} = 2.3 - 3.4 \text{ GeV}$

NICA Stage I: Experiment “The Baryonic Matter at Nuclotron”

We need for **full scale BM@N commissioning** in 2019 to have in operation:

- Injection complex: KRION, HILAc, LU20
- The Booster
- Beam Transfer Line Booster – Nuclotron (*under development at BINP*)
- Nuclotron upgraded
- BM@N Detector setup**



NICA Stage I: Experiment “The Baryonic Matter at Nuclotron”

We need for **full scale BM@N commissioning** in 2019 to have in operation:

- Injection complex: KRION, HILAc, LU20
- The Booster
- Beam Transfer Line Booster – Nuclotron (*under development at BINP*)
- Nuclotron upgraded
- BM@N Detector setup**

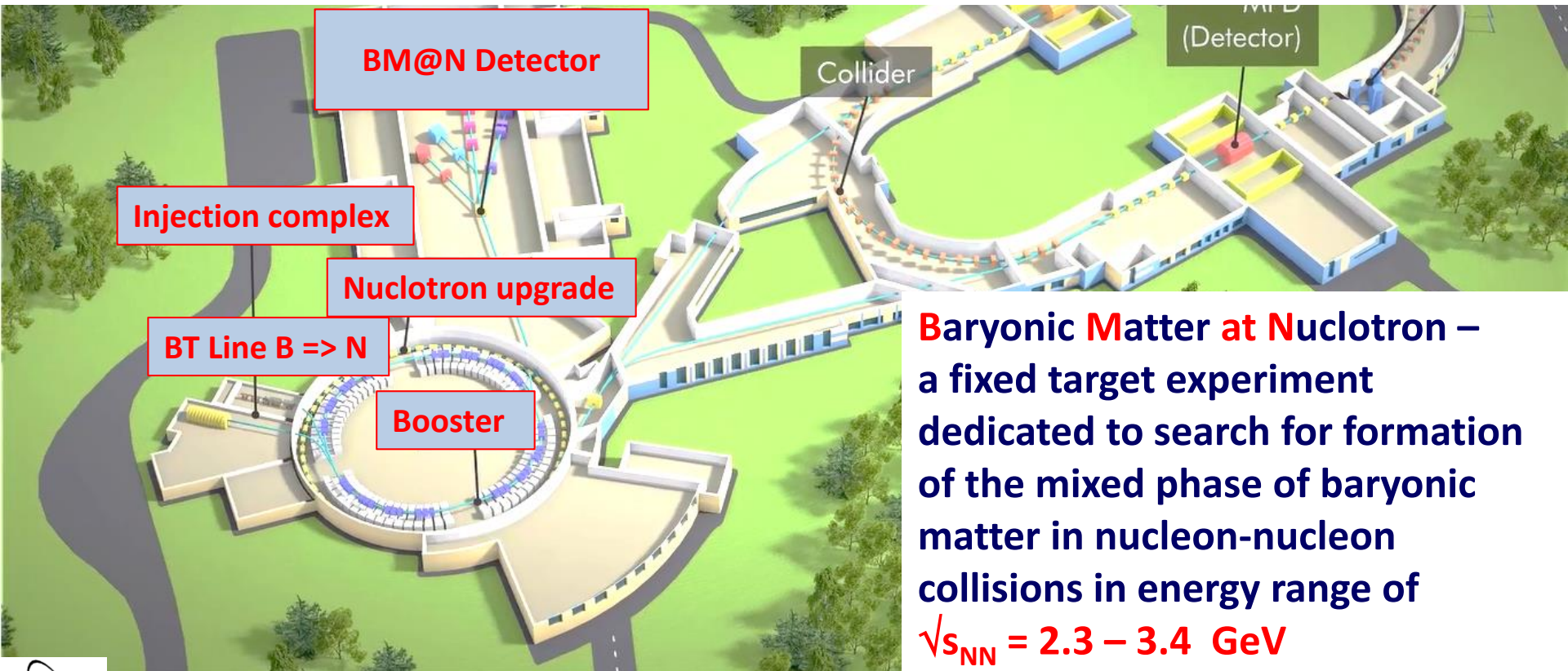

Baryonic Matter at Nuclotron – a fixed target experiment dedicated to search for formation of the mixed phase of baryonic matter in nucleon-nucleon collisions in energy range of $\sqrt{s_{NN}} = 2.3 - 3.4 \text{ GeV}$

NICA Stage I: Experiment “The Baryonic Matter at Nuclotron”

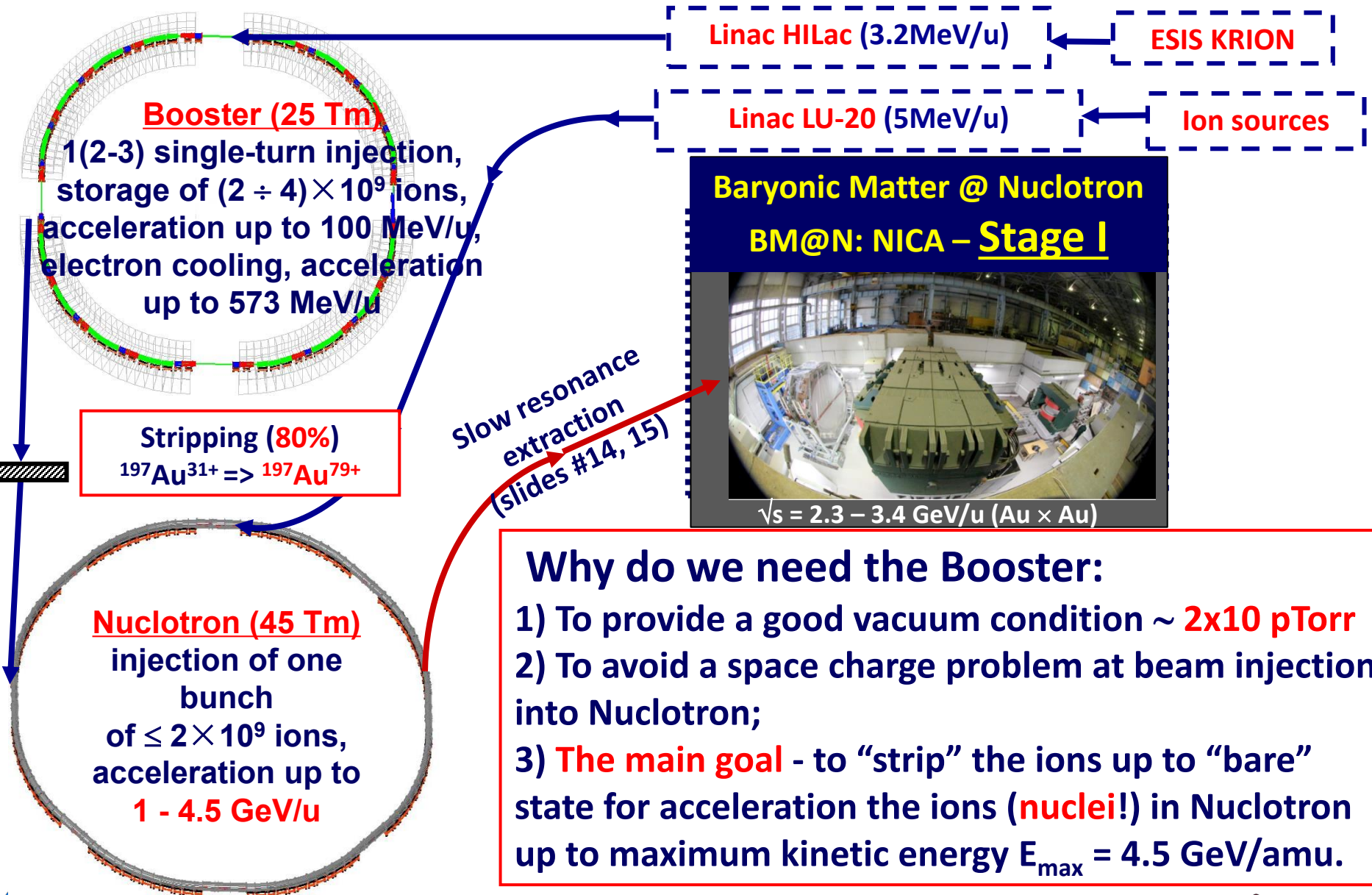

Why do we need the Booster:

- 1) To provide a good vacuum condition $\sim 2 \times 10 \text{ pTorr}$
- 2) To avoid a space charge problem at beam injection into Nuclotron;
- 3) **The main goal** - to “strip” the ions up to “bare” state for acceleration the ions (**nuclei!**) in Nuclotron up to maximum kinetic energy $E_{\text{max}} = 4.5 \text{ GeV/amu}$.

NICA Stage I: Experiment "The Baryonic Matter at Nuclotron"

Injection complex

Heavy ion source: Krion-6T ESIS



B= 5.4T reached. Test Au beams produced:
- $\text{Au}^{30+} \div \text{Au}^{32^{32+}}$, $6 \cdot 10^8$, $T_{\text{ionization}} = 20 \text{ ms}$ for
- $\text{Au}^{31+} \Rightarrow$ repetition rate 50 Hz.
To be tested at Nuclotron this October

$p \uparrow$ и $d \uparrow$ Source of Polarized Ions (SPI)



Oct.-Nov. 2016 - Very successful run:
Protons from SPI accelerated in Nuclotron.
Recovering of the spin physics
experimental program at JINR!

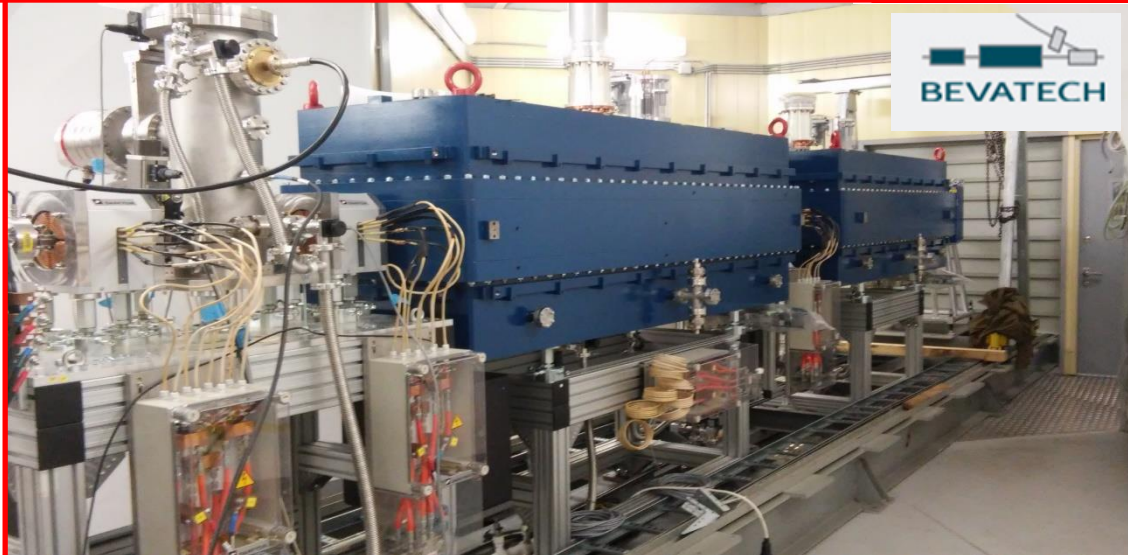

**Heavy Ion Linear
Accelerator
(HILAc)
commissioned at
VBLHEP (2016)**

**3.2 MeV/u
 Au^{31+}**

NICA Stage I: Experiment "The Baryonic Matter at Nuclotron"

Booster

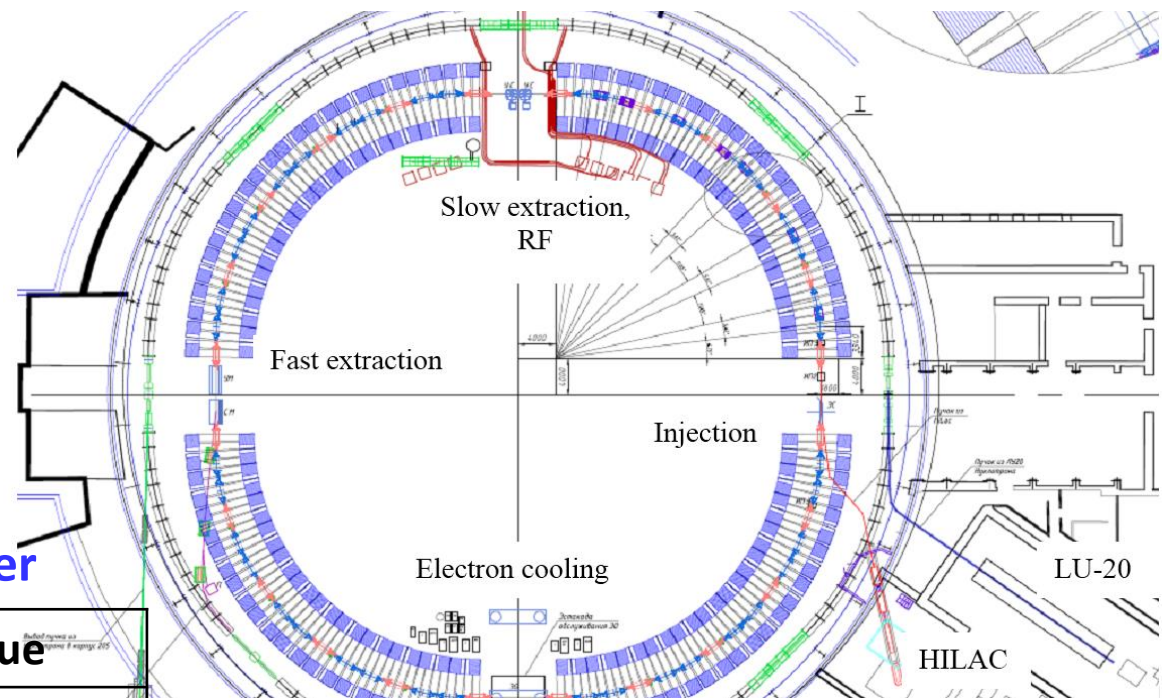

Main Parameters of NICA Booster

Parameter	Value
Ions	$p \Rightarrow {}^{197}\text{Au}^{31+}$
Circumference, m	211
Max. magnetic rigidity, $T \cdot m$	25
Injection energy, MeV/u	3.2
Extraction energy, MeV/u	578 (${}^{197}\text{Au}^{31+}$)
Max. magnetic field, T	1.8
Vacuum pressure, $p\text{Tor}$	10.0

NICA Stage I: Experiment "The Baryonic Matter at Nuclotron"

Booster

2018



Main Parameters of NICA Booster

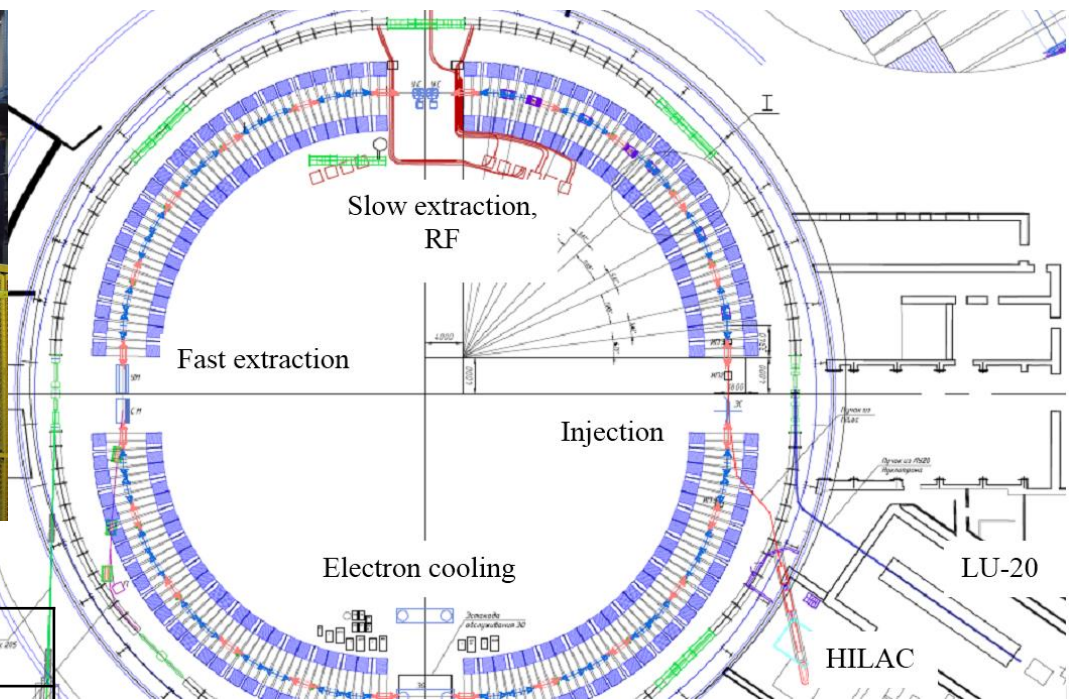

Parameter	Value
Ions	$p \Rightarrow {}^{197}\text{Au}^{31+}$
Circumference, m	211
Max. magnetic rigidity, $T \cdot m$	25
Injection energy, MeV/u	3.2
Extraction energy, MeV/u	578 (${}^{197}\text{Au}^{31+}$)
Max. magnetic field, T	1.8
Vacuum pressure, $p\text{Tor}$	10.0

NICA Stage I: Experiment "The Baryonic Matter at Nuclotron"

Booster

2018



Main Parameters of NICA Booster

Parameter	Value
Ions	$p \Rightarrow {}^{197}\text{Au}^{31+}$
Circumference, m	211
Max. magnetic rigidity, $T \cdot m$	25
Injection energy, MeV/u	3.2
Extraction energy, MeV/u	578 (${}^{197}\text{Au}^{31+}$)
Max. magnetic field, T	1.8
Vacuum pressure, $p\text{Tor}$	10.0

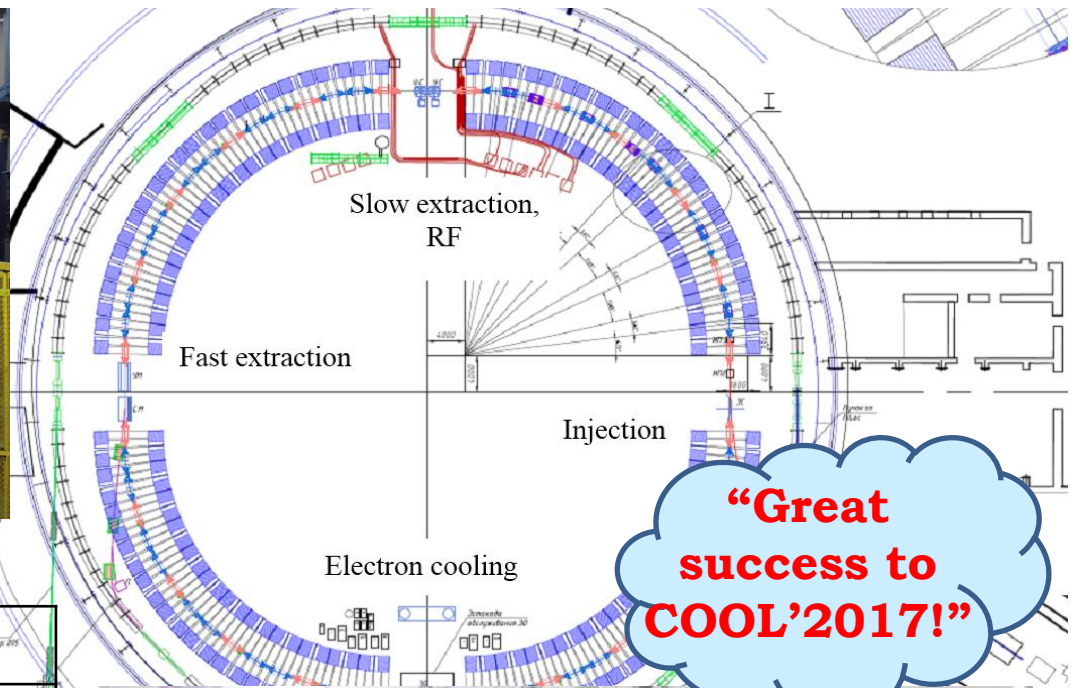

"Great success to COOL'2017!"

August 28, 2017



G.Khodzhibagiy
S.Kostromin

Booster

Plan and status of the Booster magnets' fabrication & testing

Magnet	Total number	Fabricated & Tested 02.01.2017	Plan/ Tested 12.09.2017
Dipole	40	7	28/25
Quadrupole	48	4	20/6



G.Khodzhibagiy
S.Kostromin

Booster

Plan and status of the Booster magnets' fabrication & testing

Magnet	Total number	Fabricated & Tested 02.01.2017	Plan/ Tested 12.09.2017
Dipole	40	7	28/25
Quadrupole	48	4	20/6



NICA Stage I: Experiment “The Baryonic Matter at Nuclotron” Electron cooler for the Booster

Booster

Designed, fabricated and presently under commissioning by BINP Team



Vasily Parkhomchuk...

Parameter	Value
Ions to be cooled	$p \Rightarrow {}^{197}\text{Au}^{31+}$
Electron energy, <i>keV</i>	1.5 – 50
Beam current, <i>Amp</i>	0.2 – 1.0
Cooling section length, <i>m</i>	1.9
Electron energy variation, $\Delta E/E$	$\leq 1 \cdot 10^{-5}$
Beam current stability, $\Delta I/I$	$\leq 1 \cdot 10^{-4}$
Beam current losses, $\delta I/I$	$\leq 3 \cdot 10^{-5}$
Solenoid magnetic field, <i>T</i>	0.1 – 0.2
Field ripples, $\Delta B/B$ on 15 cm	$\leq 3 \cdot 10^{-5}$

Why do we need an electron cooler for the Booster:

- 1) To provide a multiturn or multicycle (3 pulses at 10 Hz repetition) injection;
- 2) To form ion bunches of a small 6D emittance (Wait for continuation until slide # 15 – slow resonance extraction.)

Details have been presented in the the talk of Alexander Bublei (Tuesday, 9:00)



...and his coolers' construction team

Booster

Why do we need an electron cooler for the Booster

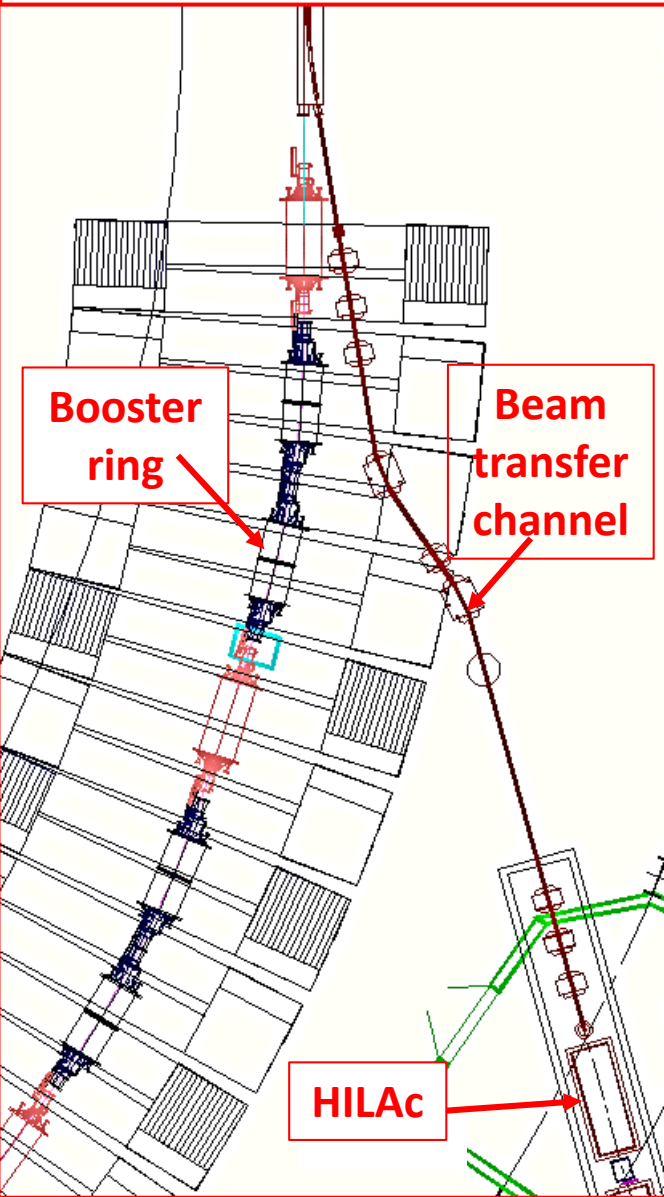

The beam injection methods:

- single-turn
- multiturn with e-cooling
- multiple with e-cooling

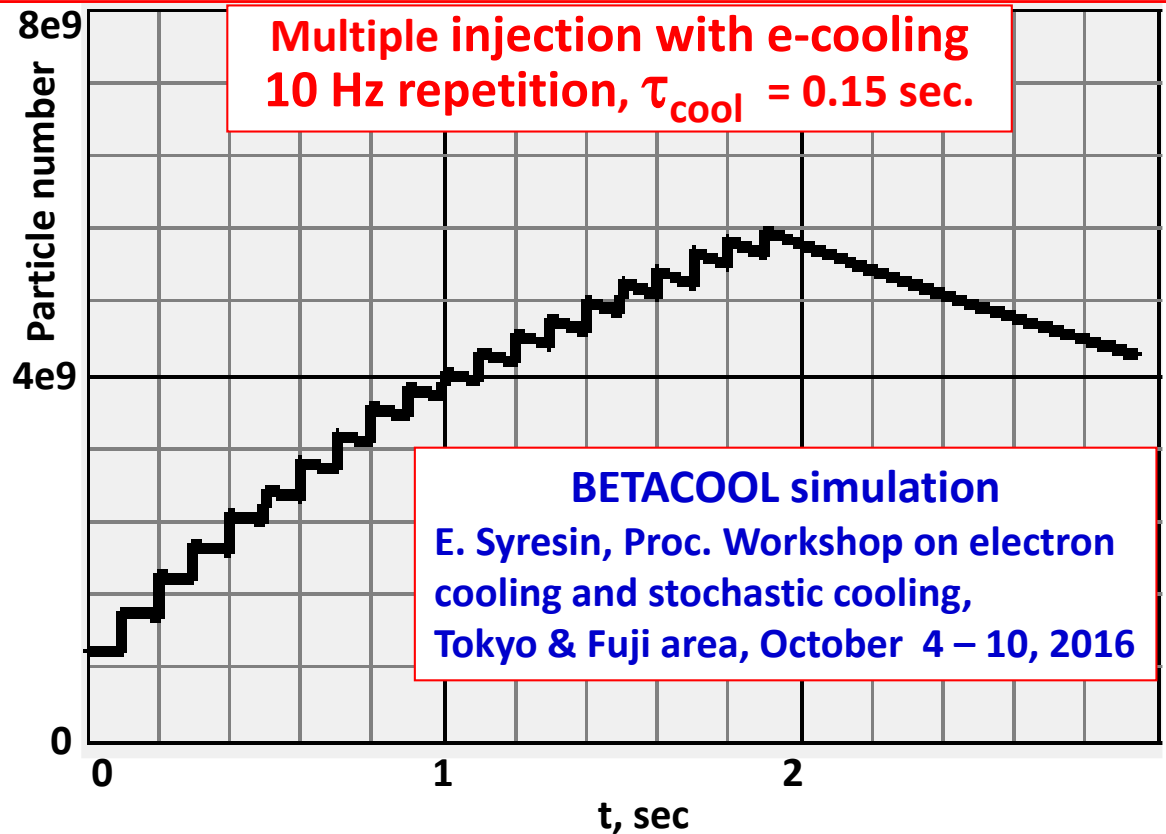

Booster

Why do we need an electron cooler for the Booster

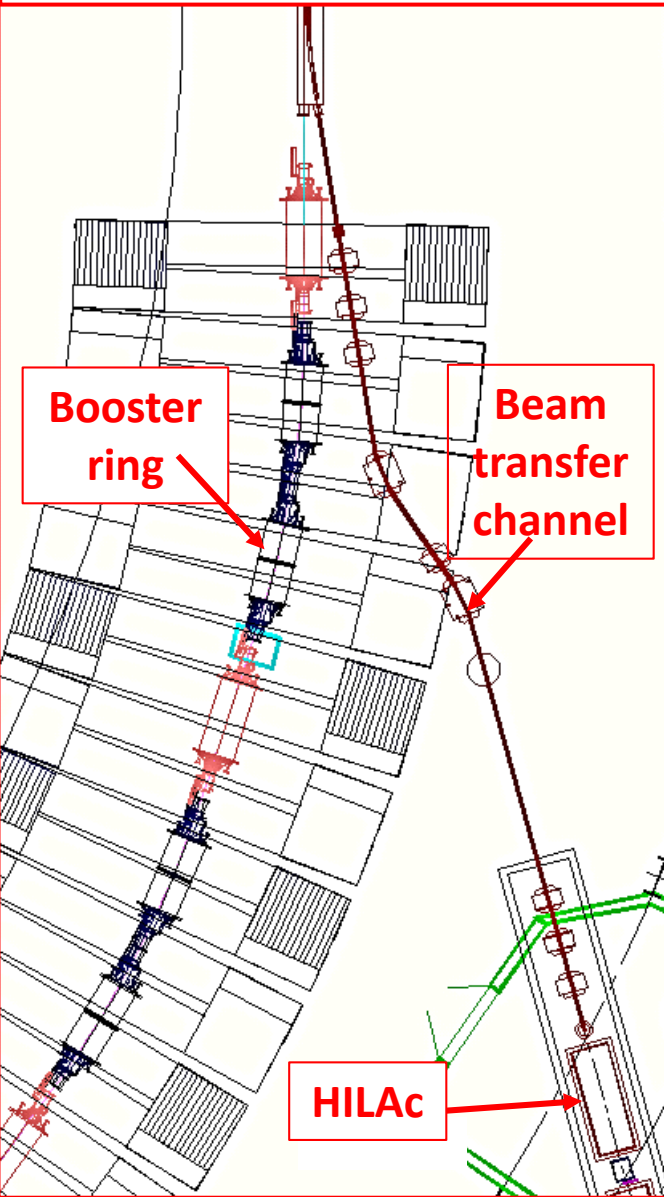

The beam injection methods:

- single-turn
- multiturn with e-cooling
- multiple with e-cooling

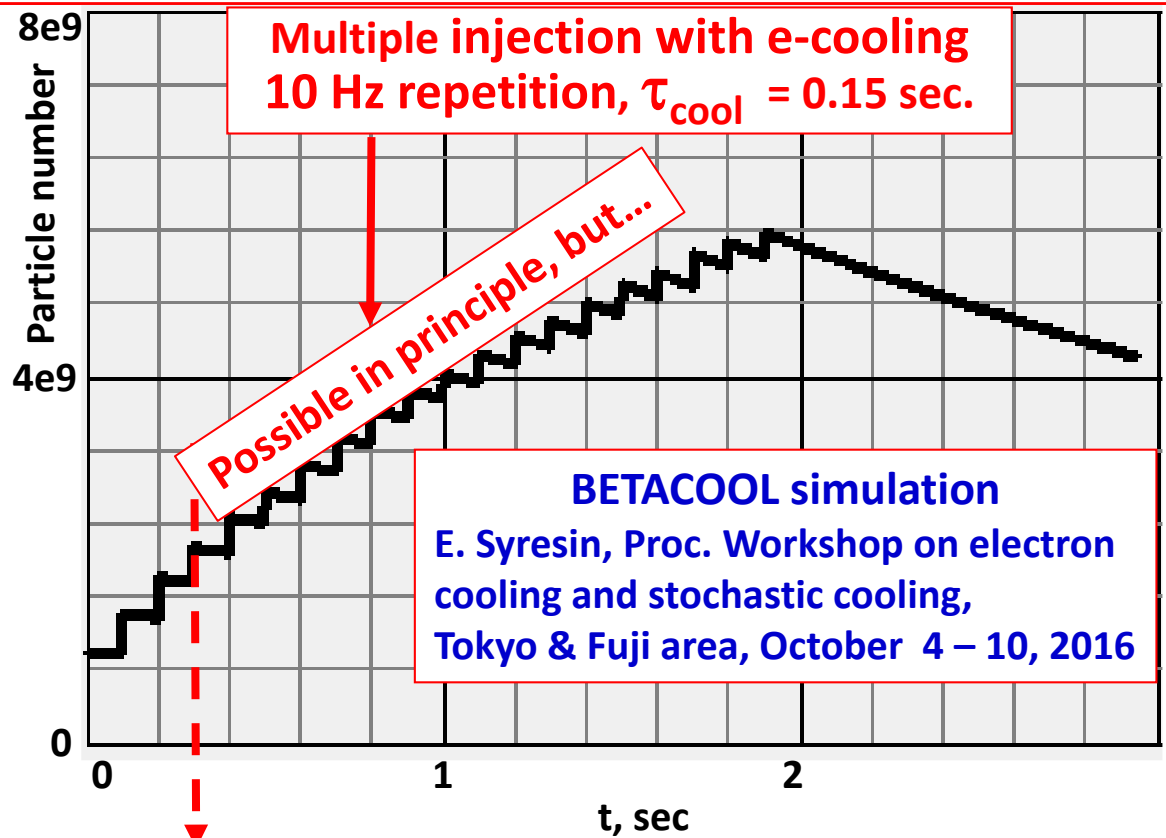

...3 cycles only: limited by the HILAc quads heating

NICA Stage I: Experiment "The Baryonic Matter at Nuclotron"

Booster

Application of electron cooling, ions $^{197}\text{Au}^{31+}$

Booster cycle



Injection and e-cooling

$$E_{\text{ion}} = 3.2 \text{ MeV/u},$$

$$I_e = 0.3 \text{ A},$$

$$\tau_{\text{cool}} = 0.16 \text{ s}$$

$$E_{\text{ion}} = 90 \text{ MeV/u},$$

$$I_e = 1 \text{ A}, a_e = 0.5 \text{ cm}$$

$$\tau_{\text{cool}} = 0.27 \text{ s}$$

$$\tau_{\text{cool}} = - \frac{1}{\gamma A_{\text{ion}} m_{\text{nucleon}}} \cdot \int_{\Delta_{tr}}^{0.1\Delta_{tr}} \frac{dV_{tr}}{F_{VVP}(V_{tr} = V_{\text{ion}})}, \quad \Delta_{tr} = \sqrt{\frac{T_{e\perp}}{m_e}}$$

Beam Transfer from The Booster to The Nuclotron

Under design, fabrication and further mounting/commissioning by BINP Team

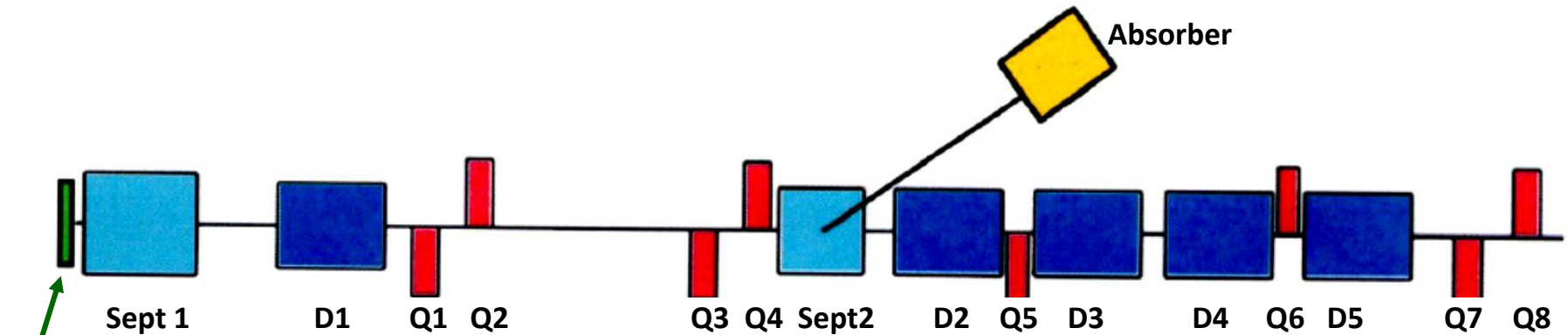
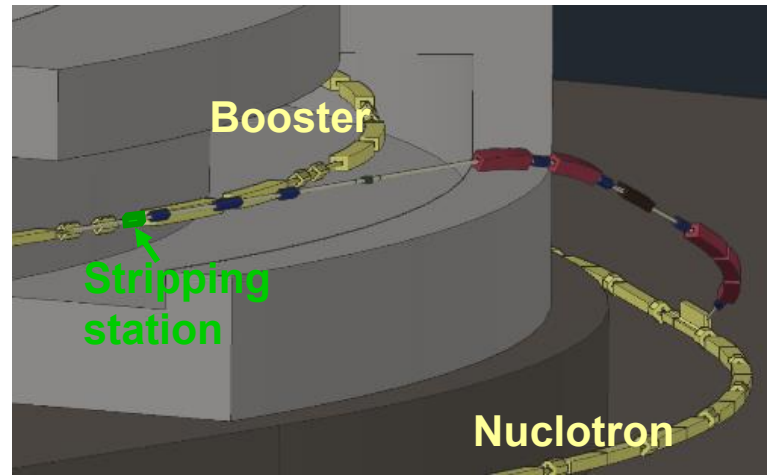
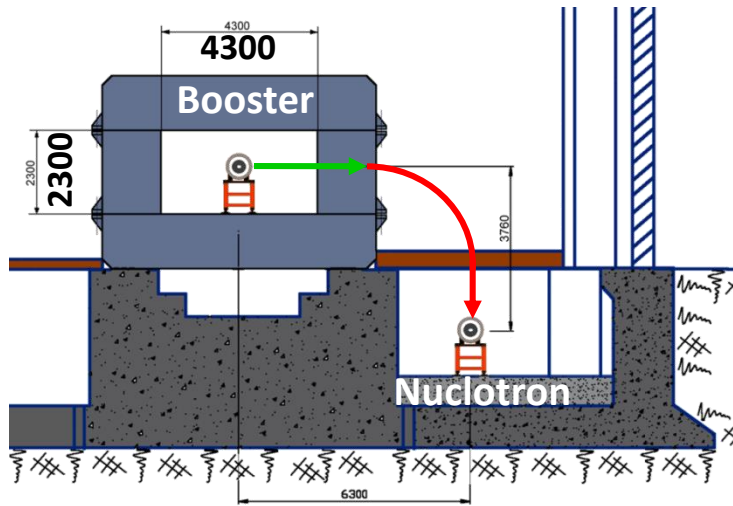

Lattice of the BTC from The Booster to The Nuclotron *A.Tuzikov, (NICA Team)*

Beam Transfer from The Booster to The Nuclotron

Under design, fabrication and further mounting/commissioning by BINP Team

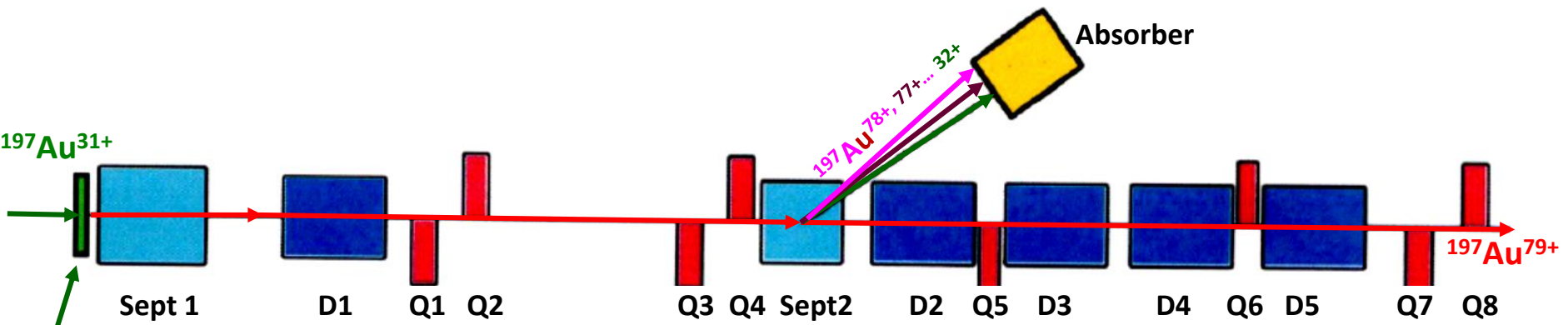
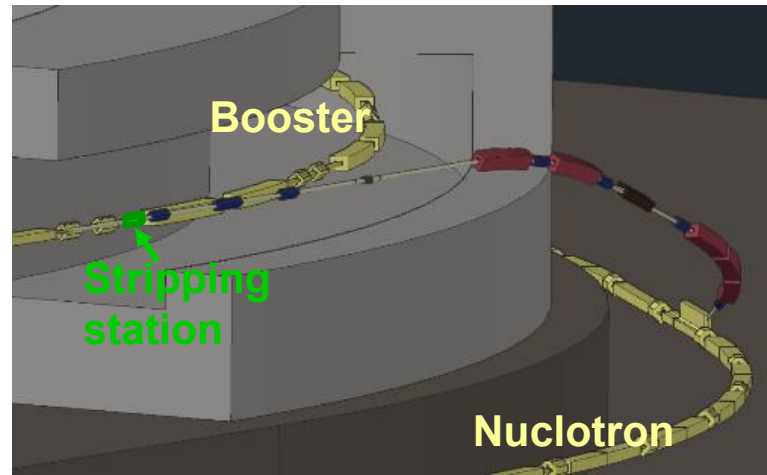
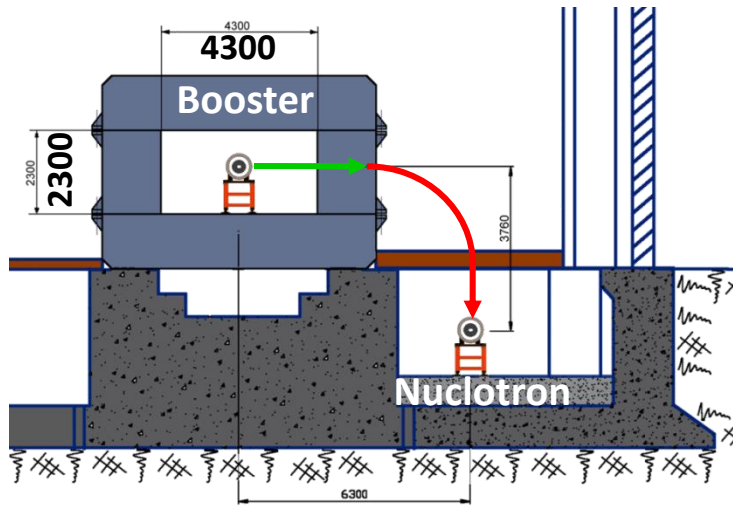

Lattice of the BTC from The Booster to The Nuclotron *A.Tuzikov, (NICA Team)*

Beam Transfer from The Booster to The Nuclotron

Under design, fabrication and further mounting/commissioning by BINP Team

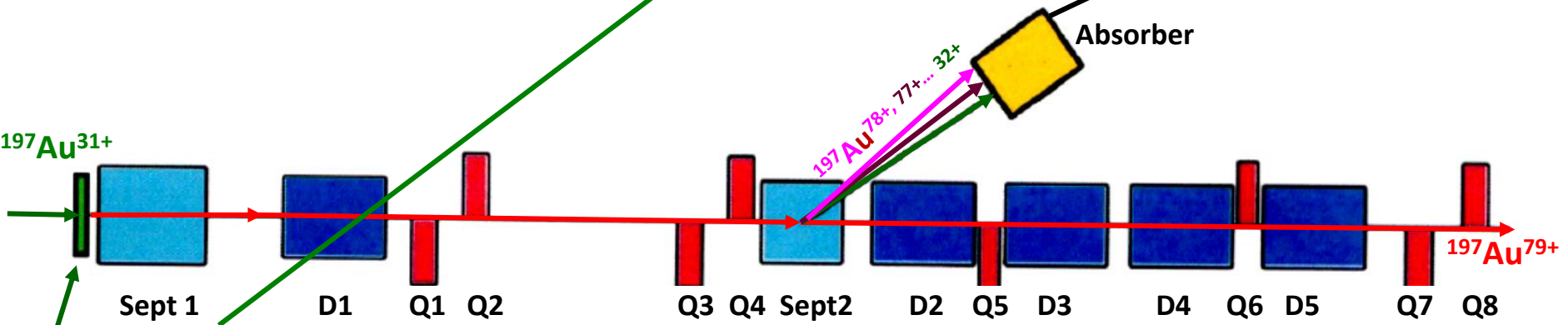
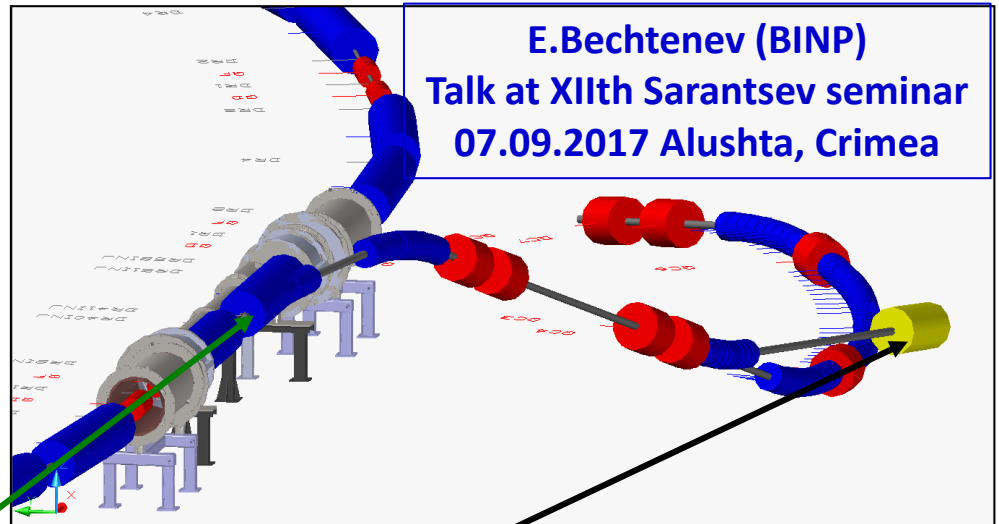
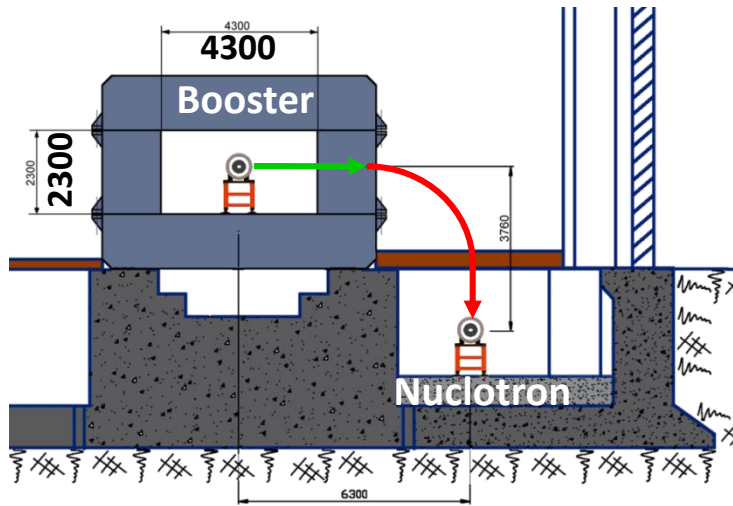

Lattice of the BTC from The Booster to The Nuclotron *A.Tuzikov, (NICA Team)*

Nuclotron Upgrade

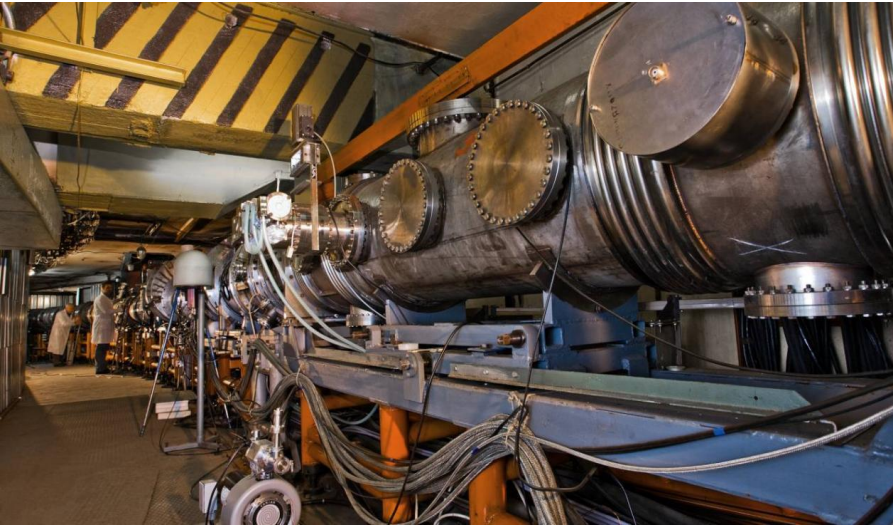

Nuclotron is SC synchrotron accelerating ions and delivering **presently** ion beams:

deuterons $E_{\max} = 4.8 \text{ GeV/u}$ ($B = 1.7 \text{ T}$)

$^{124}\text{Xe}^{42+}$ $E_{\max} = 3.0 \text{ GeV/u}$ ($B = 1.7 \text{ T}$).

The Nuclotron upgrade tasks for *heavy ion* mode:

- Acceleration of $^{197}\text{Au}^{79+}$ up to 4.5 GeV/u
- Injection system for $^{197}\text{Au}^{79+}$ transferred from the Booster at 600 MeV/u
- Slow extraction system for $^{197}\text{Au}^{79+}$ at $1 \div 4.5 \text{ GeV/u}$ (the next slide)
- Upgrade of control system (synchronization!)

NICA Stage I: Experiment "The Baryonic Matter at Nuclotron"

Slow Resonance Extraction

Phase trajectories in vicinity of a resonance $(Q_x)_{res} = n + 1/3^*$

red lines - boundary of the resonance separatrix,

Colour curves - particle phase trajectories at different values of the resonance detuning:

$$\delta = Q_x - Q_{res}$$

p_x, x, δ - in arbitrary units!

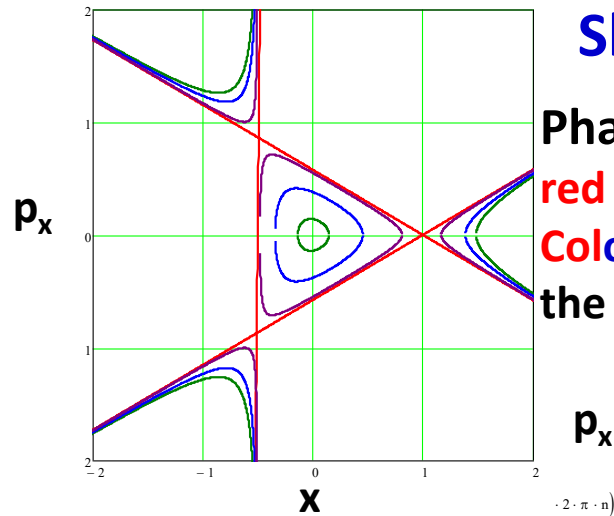

NICA Stage I: Experiment "The Baryonic Matter at Nuclotron"

Slow Resonance Extraction

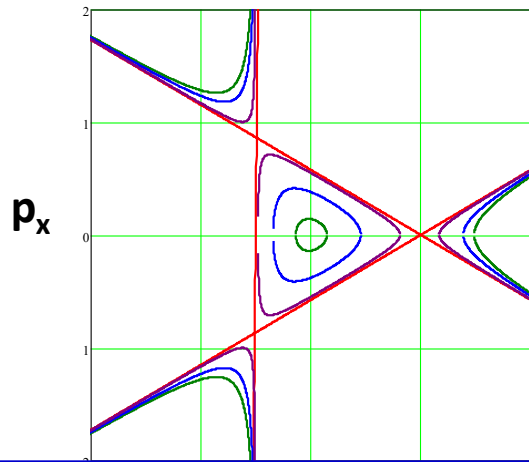

Phase trajectories in vicinity of a resonance $(Q_x)_{res} = n + 1/3^*)$

red lines - boundary of the resonance separatrix,
Colour curves - particle phase trajectories at different values of the resonance detuning:

$$\delta = Q_x - Q_{res}$$

p_x, x, δ - in arbitrary units!

Phase trajectories in vicinity of a resonance $(Q_x)_{res} = n + 1/3$ **at slow variation of the detuning δ**
Dark red dashed curves - trajectories of particles leaving a symmetric separatrix

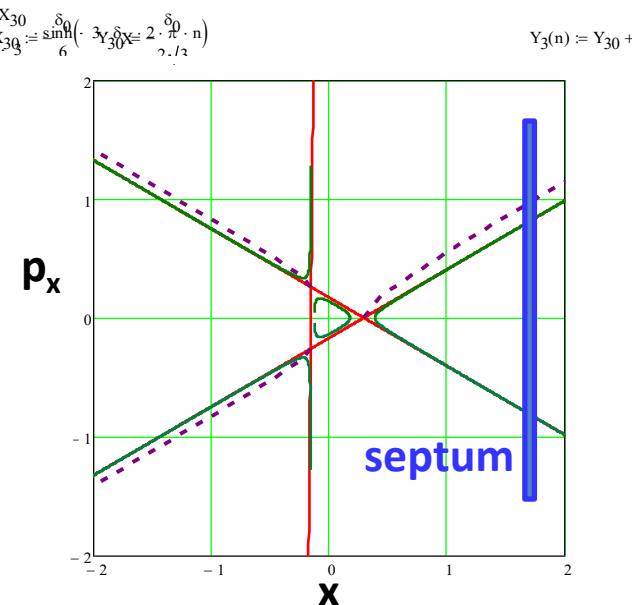
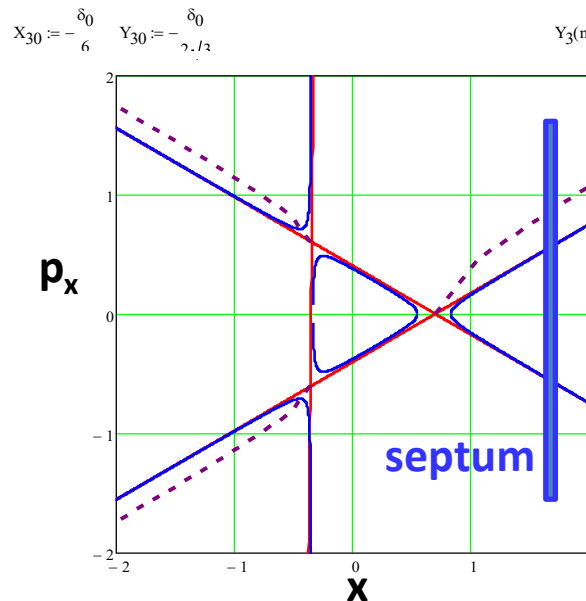
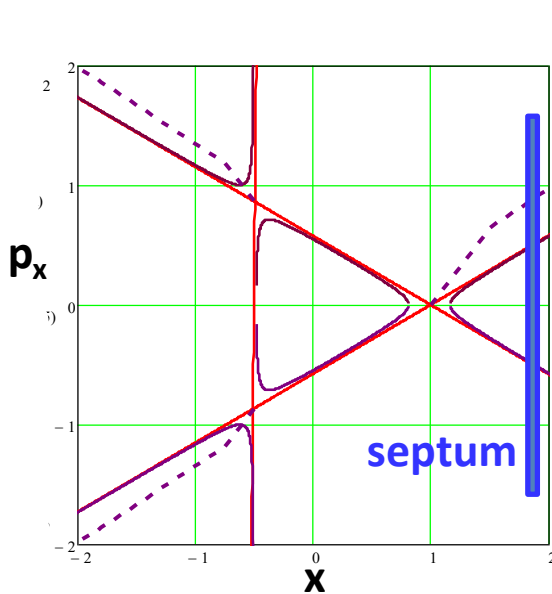

NICA Stage I: Experiment "The Baryonic Matter at Nuclotron"

Slow Resonance Extraction

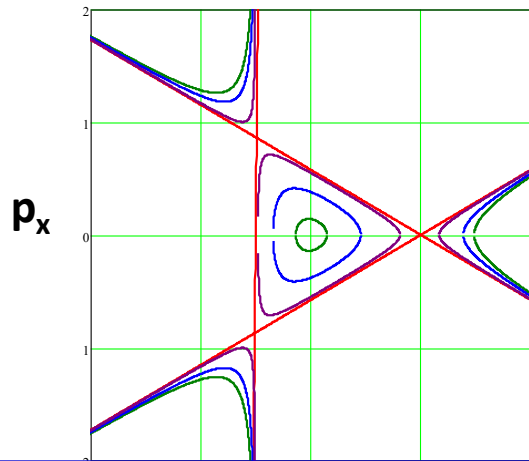

Phase trajectories in vicinity of a resonance $(Q_x)_{res} = n + 1/3^{*})$

red lines - boundary of the resonance separatrix,
Colour curves - particle phase trajectories at different values of the resonance detuning:

$$\delta = Q_x - Q_{res}$$

p_x, x, δ - in arbitrary units!

Phase trajectories in vicinity of a resonance $(Q_x)_{res} = n + 1/3$ **at slow variation of the detuning δ**
Dark red dashed curves - trajectories of particles leaving a symmetric separatrix

Green solid curves - trajectories of the particles leaving the separatrix, which is especially deformed, at **$\delta(t)$ variation in time**

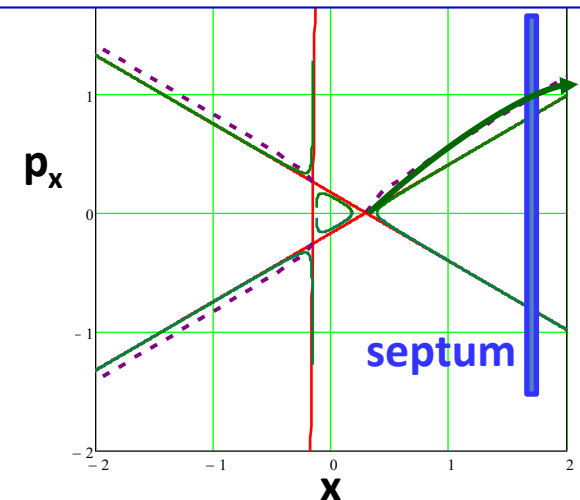
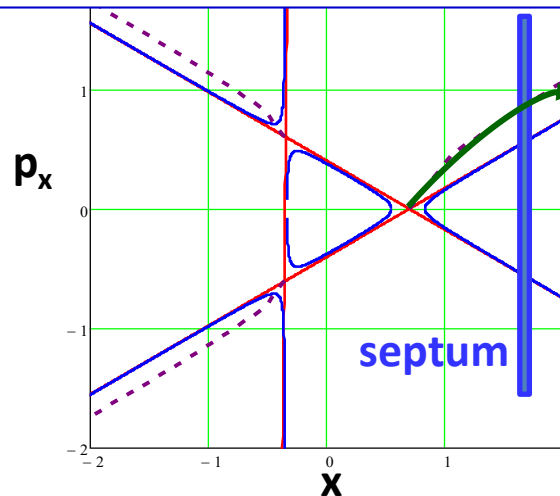
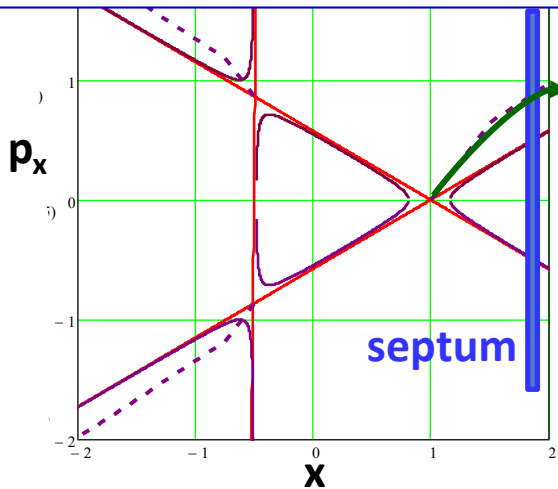

NICA Stage I: Experiment “The Baryonic Matter at Nuclotron”

Slow Resonance Extraction

The dream of experimenters is to have at a slow particle extraction **as long as possible an extracted particles' flux of constant intensity**

$$J(\delta) = \frac{dN}{d\delta} \cdot \frac{d\delta}{dt}$$

For this purpose one needs to have a proper dependence on time of the function

$$\delta(t) = Q_x(t) - Q_{res} \cdot$$

The *numerical simulation* of particle dynamics at slow resonant extraction shows that one can have **a constant flux of extracted particles** and **increase the extraction time** reducing the beam emittance.

NICA Stage I: Experiment “The Baryonic Matter at Nuclotron”

Slow Resonance Extraction

The dream of experimenters is to have at a slow particle extraction **as long as possible an extracted particles' flux of constant intensity**

$$J(\delta) = \frac{dN}{d\delta} \cdot \frac{d\delta}{dt}$$

For this purpose one needs to have a proper dependence on time of the function

$$\delta(t) = Q_x(t) - Q_{res} \cdot$$

The *numerical simulation* of particle dynamics at slow resonant extraction shows that one can have **a constant flux of extracted particles** and **increase the extraction time** reducing the beam emittance.

Dependence of $\delta(t)$ on time at **constant particle flux $J(\delta)$** (arb. units) at slow resonant extraction of Gaussian beam at different values of the beam emittances: $\sigma_x = \sigma_p =$
= **0.1 (1)**, **0.3 (2)**, **1.0 (3)**
(arb. units).

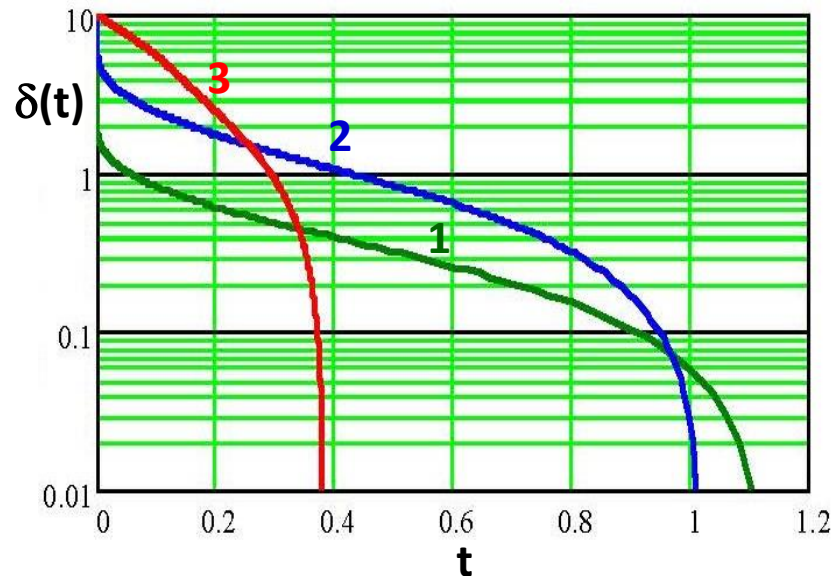

One can conclude:
Electron cooling allows us to control in wider range the intensity of the extracted ion flux.

Here the tune dependence on time $\delta(t)$ is described with a function obtained by numerical simulation .
Details of these simulations will be published later.

NICA Stage I: Experiment "The Baryonic Matter at Nuclotron"

Detector for BM@N Experiment

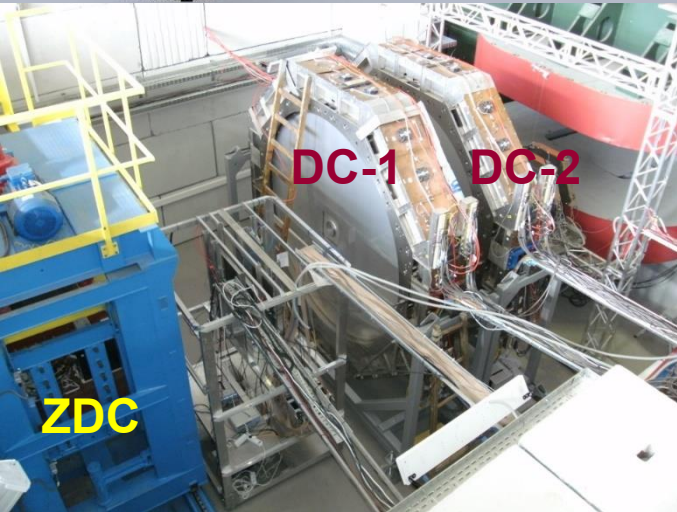
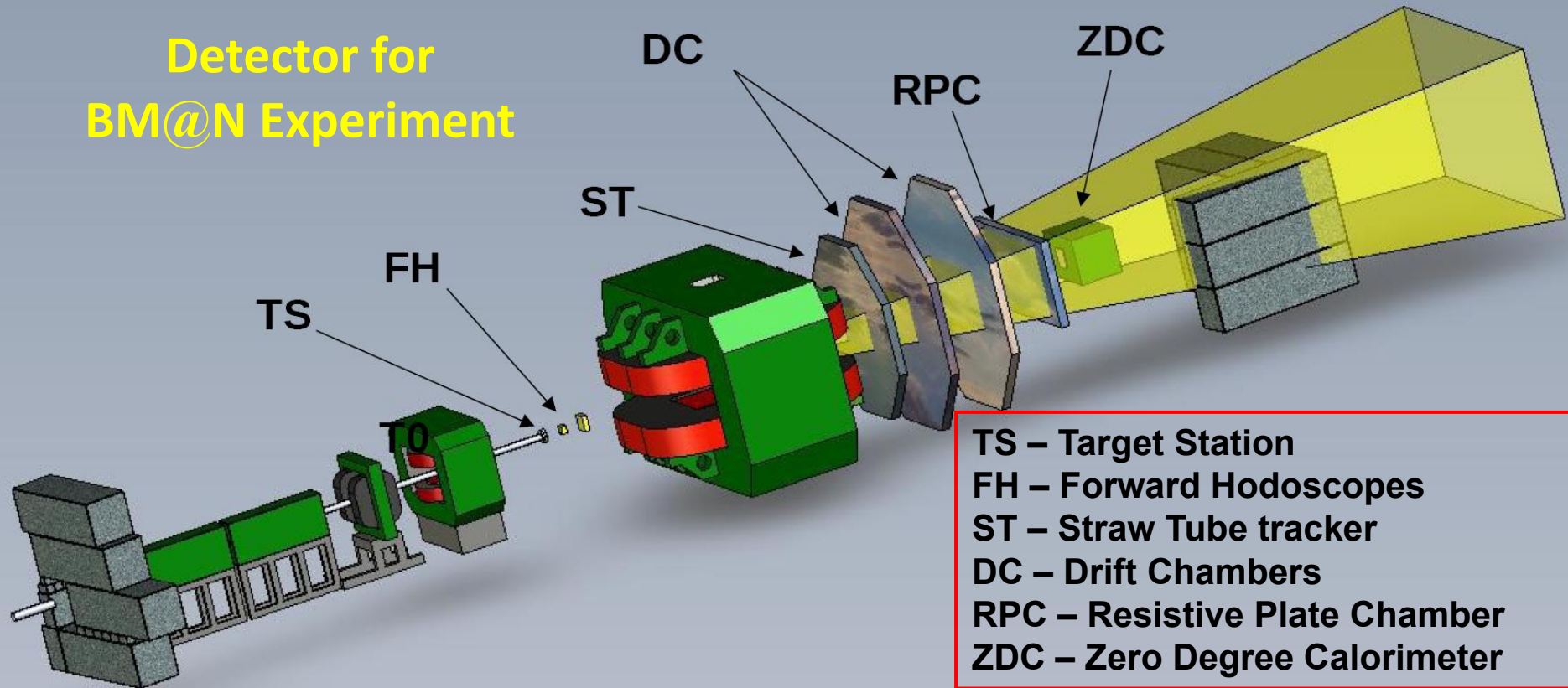

NICA Stage I: Experiment "The Baryonic Matter at Nuclotron"

Detector for BM@N Experiment

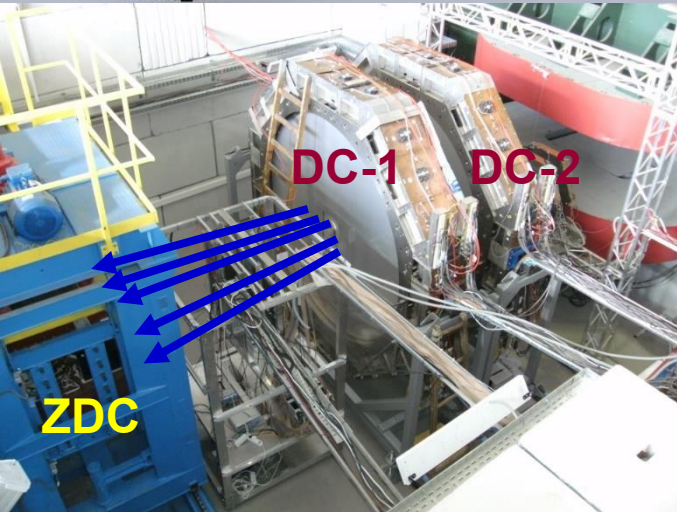
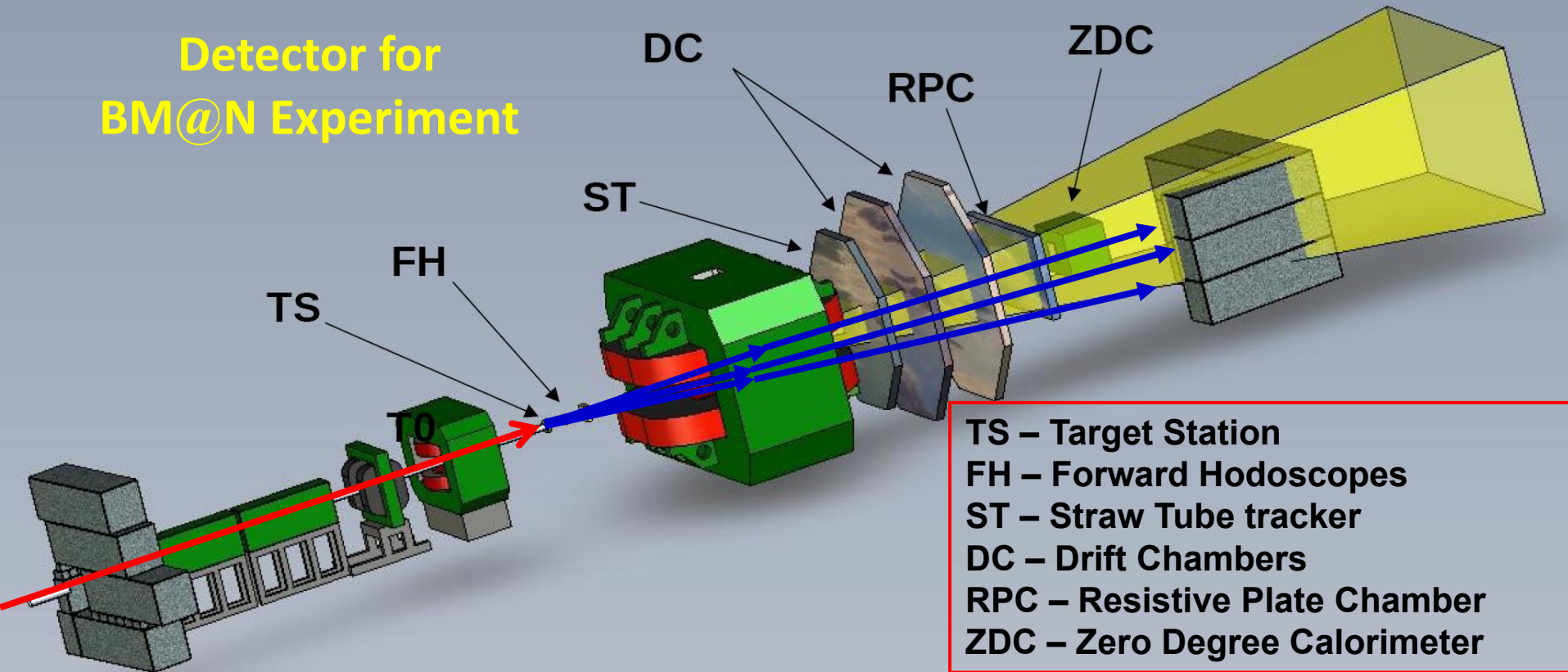

NICA Stage I: Experiment "The Baryonic Matter at Nuclotron"

Detector for BM@N Experiment

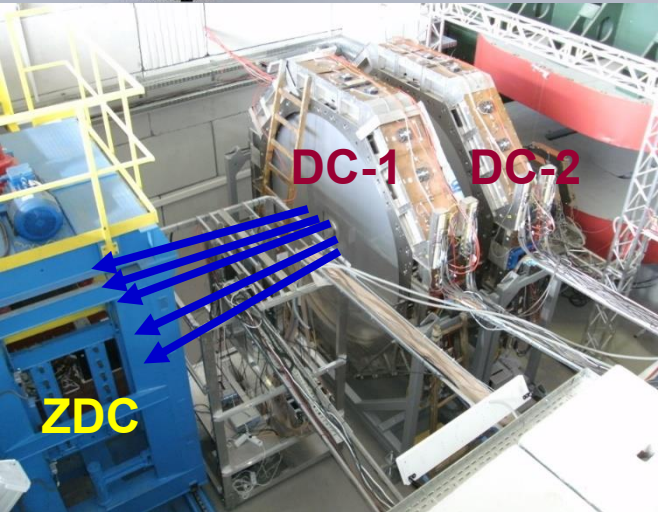
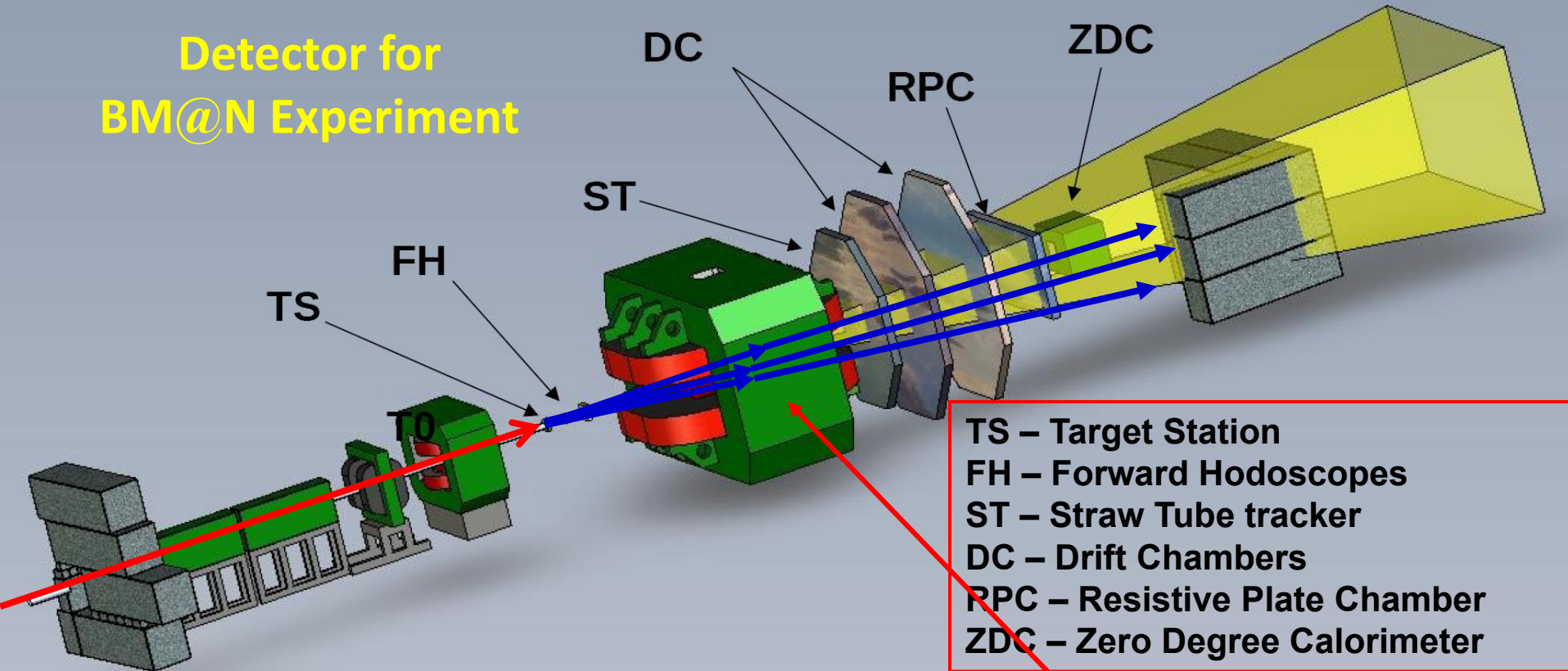

June 2016:
Commissioning at the Nuclotron beam subdetector located inside analyzing magnet



NICA Stage II: Search for The Mixed Phase and New Physics In Heavy Ions' Collisions at NICA Collider

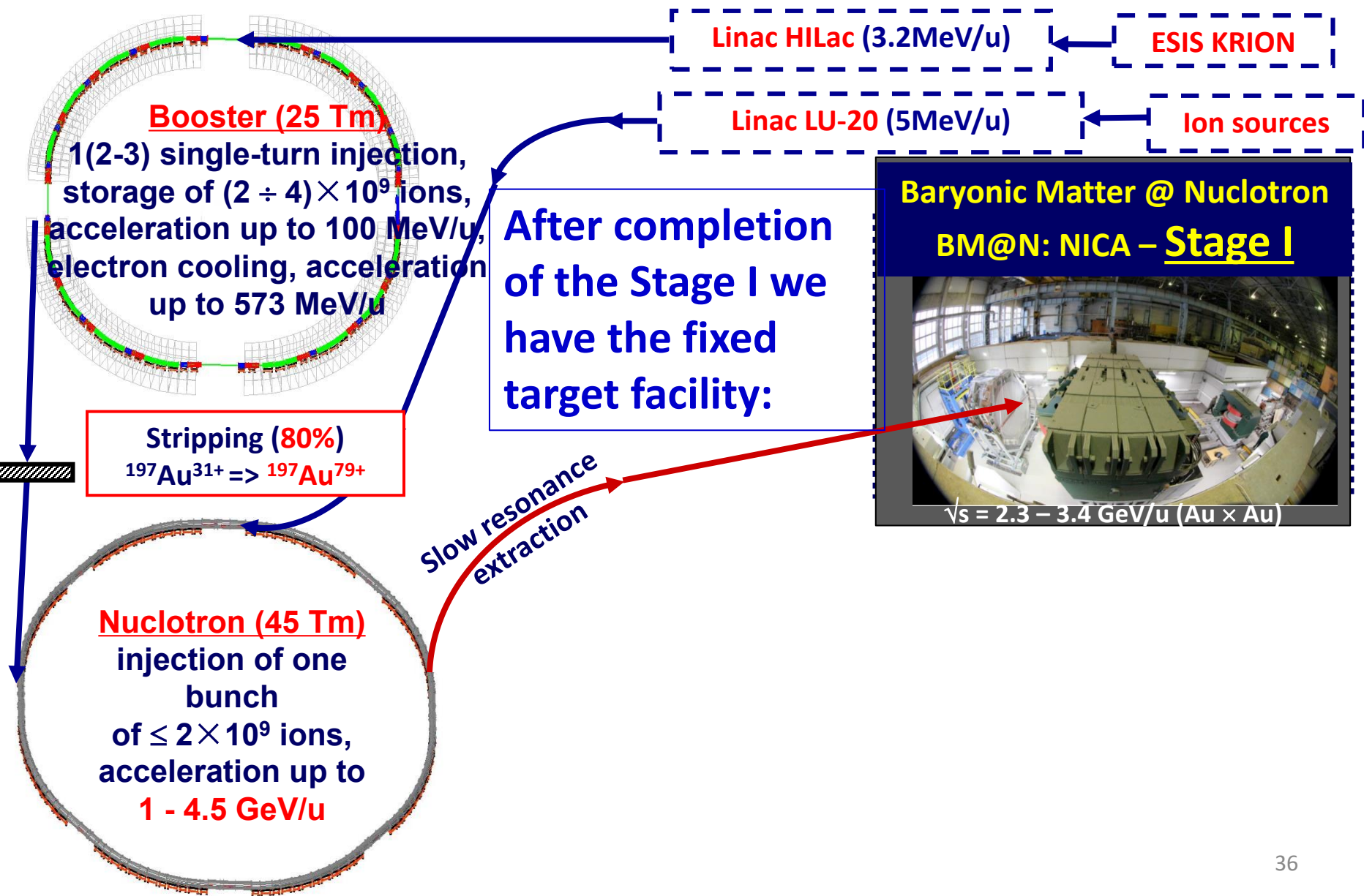

NICA Stage II: Search for The Mixed Phase and New Physics In Heavy Ions' Collisions at NICA Collider

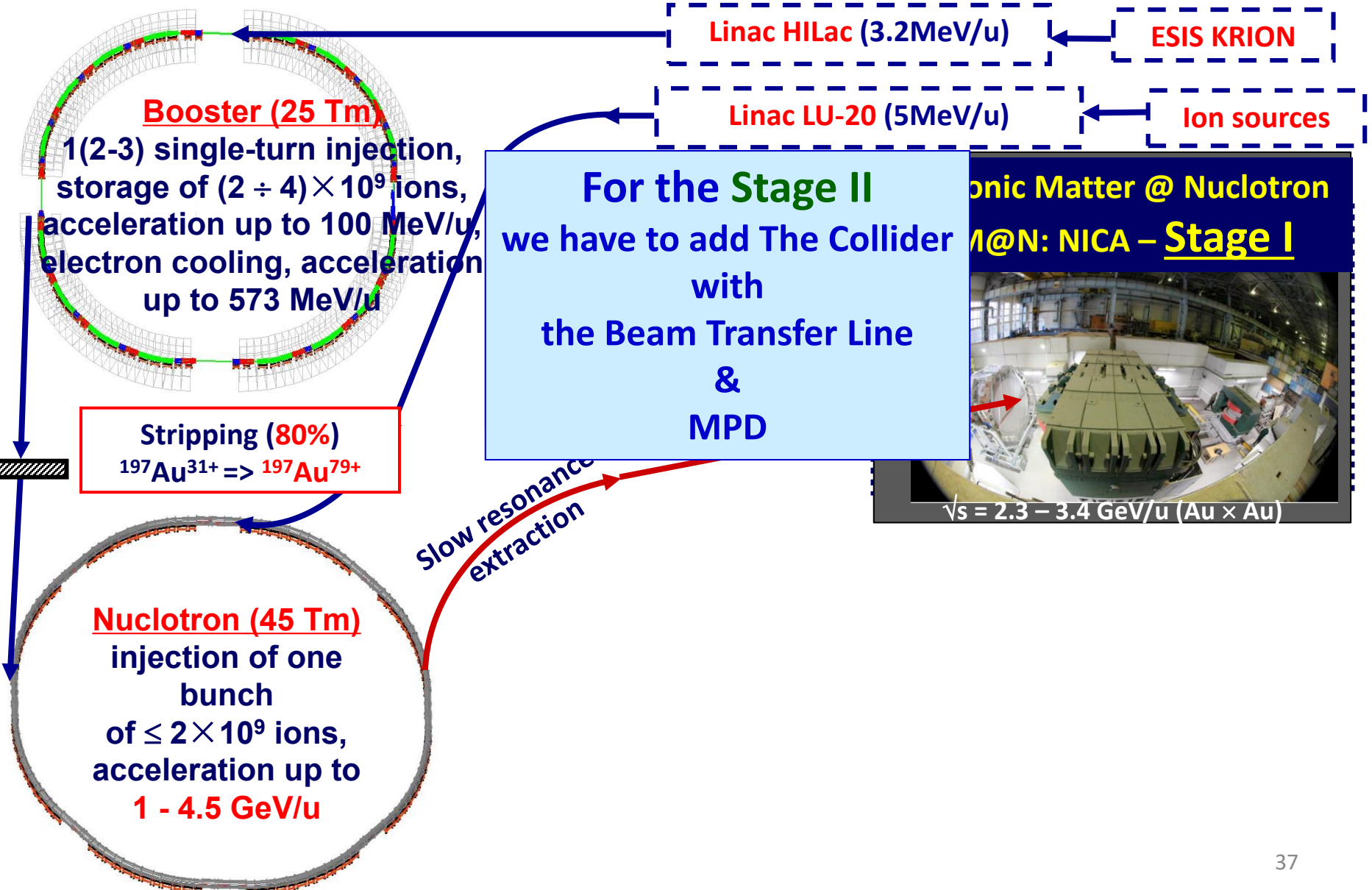

NICA Stage II: Search for The Mixed Phase and New Physics In Heavy Ions' Collisions at NICA Collider

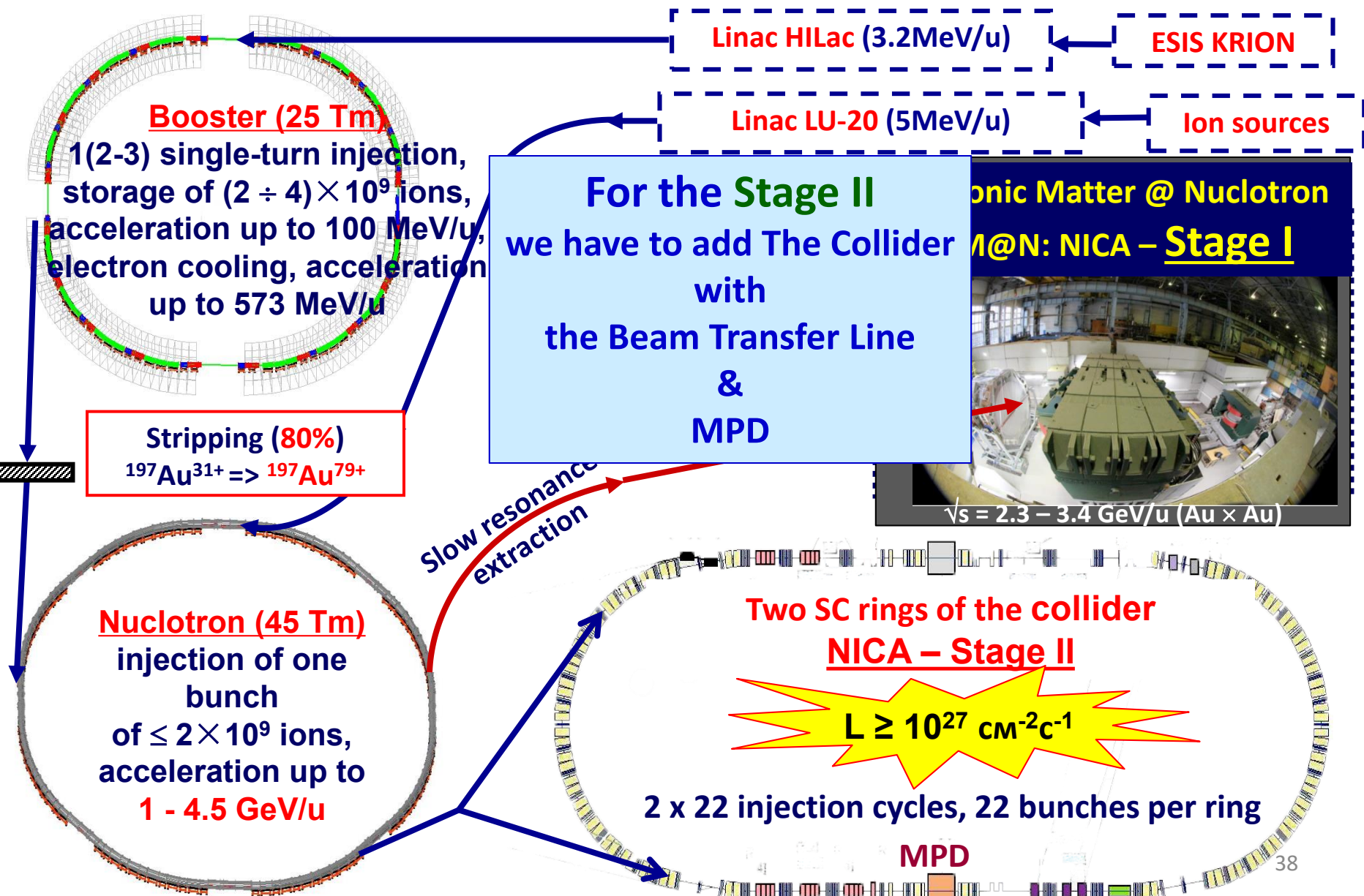

Stage II: Search for The Mixed Phase and New Physics In Heavy Ions' Collisions at NICA Collider

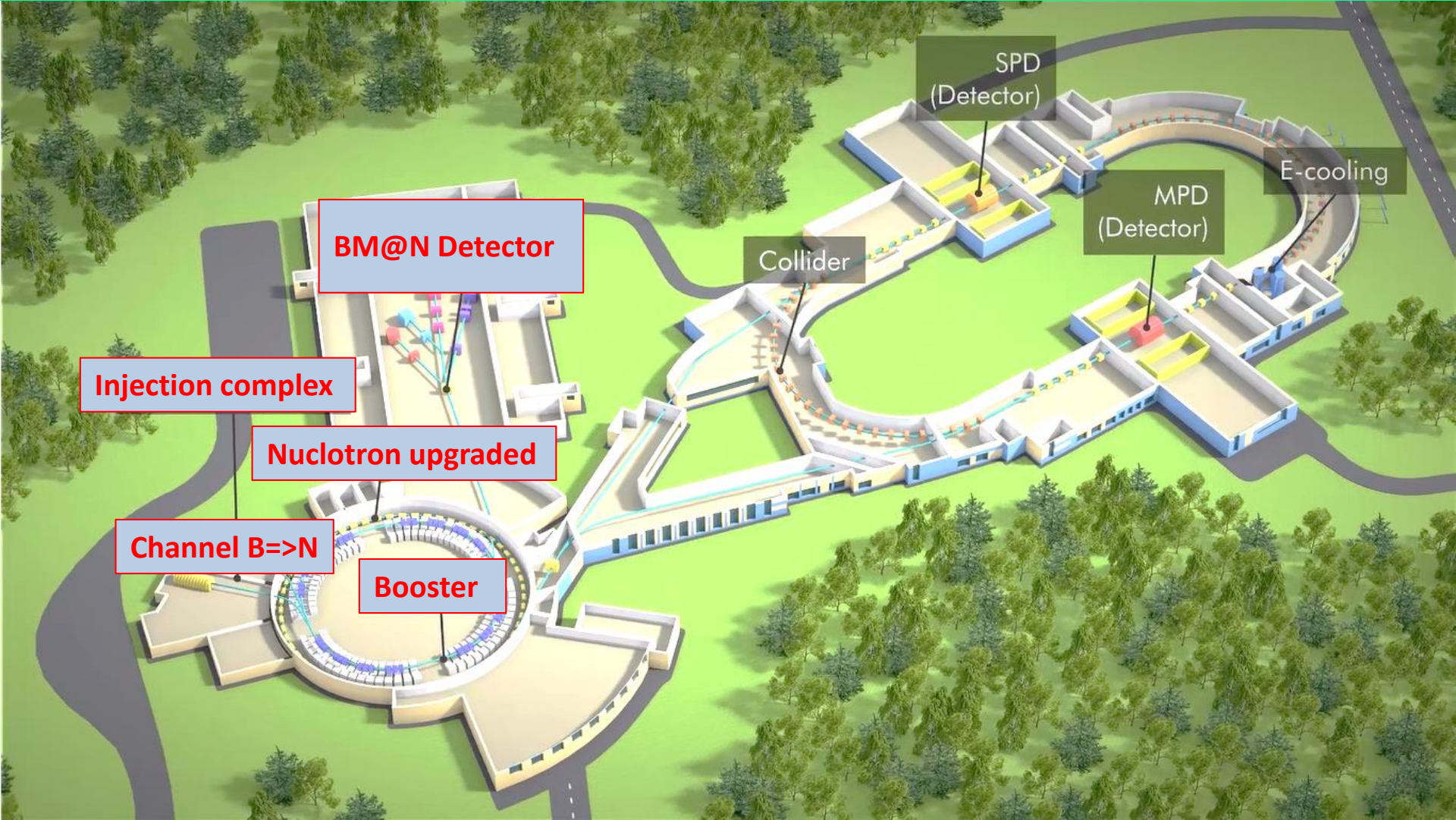

Stage II: Search for The Mixed Phase and New Physics In Heavy Ions' Collisions at NICA Collider

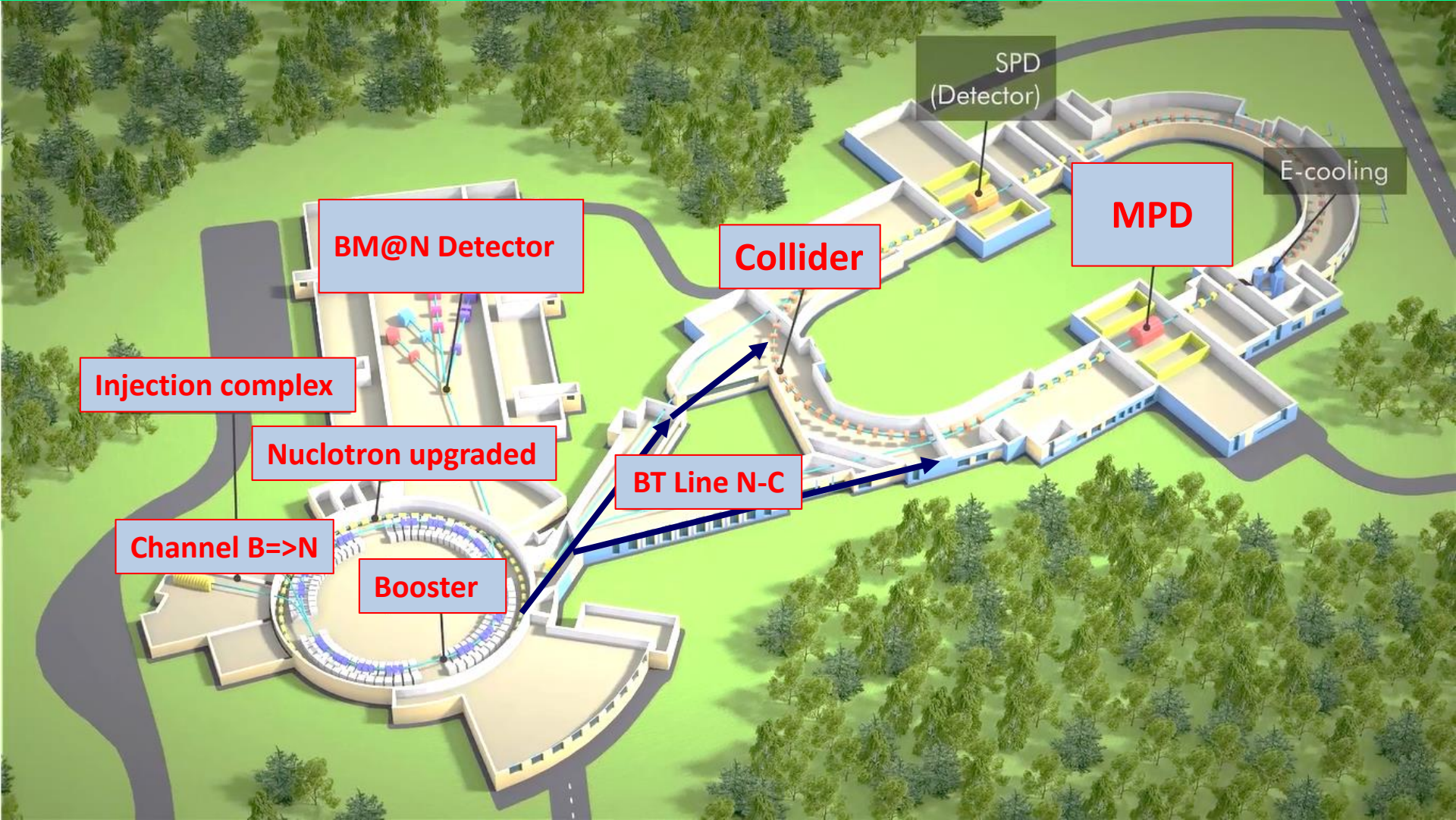

**Beam Transfer Channel
from
Nuclotron to Collider**

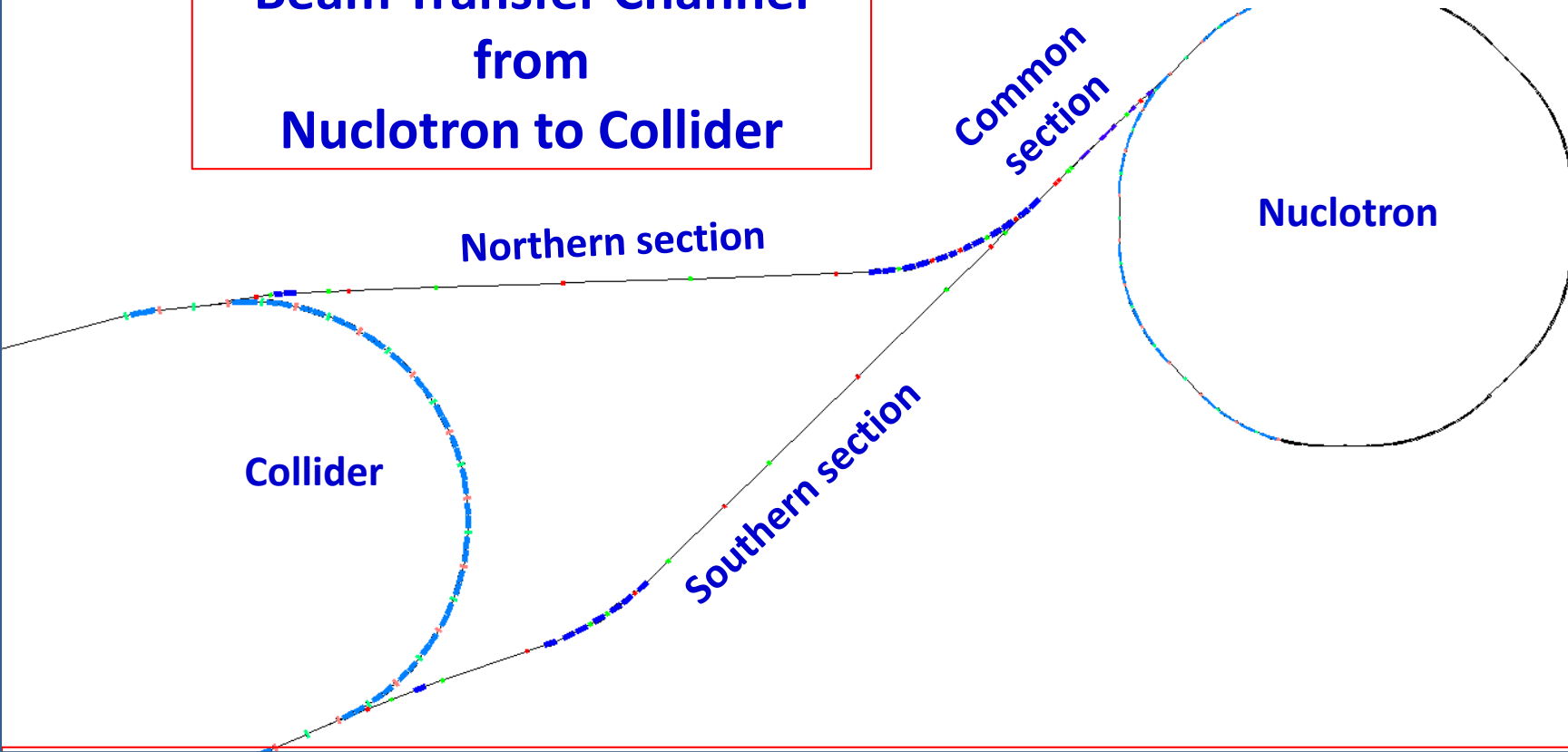

Conceptual design (channel lattice, parameters of elements, etc.) –

- Alexei Tuzikov and NICA team

Technical project, working design, fabrication, mounting and commissioning –

- SigmaPhi C^o (France)

Collider rings composition

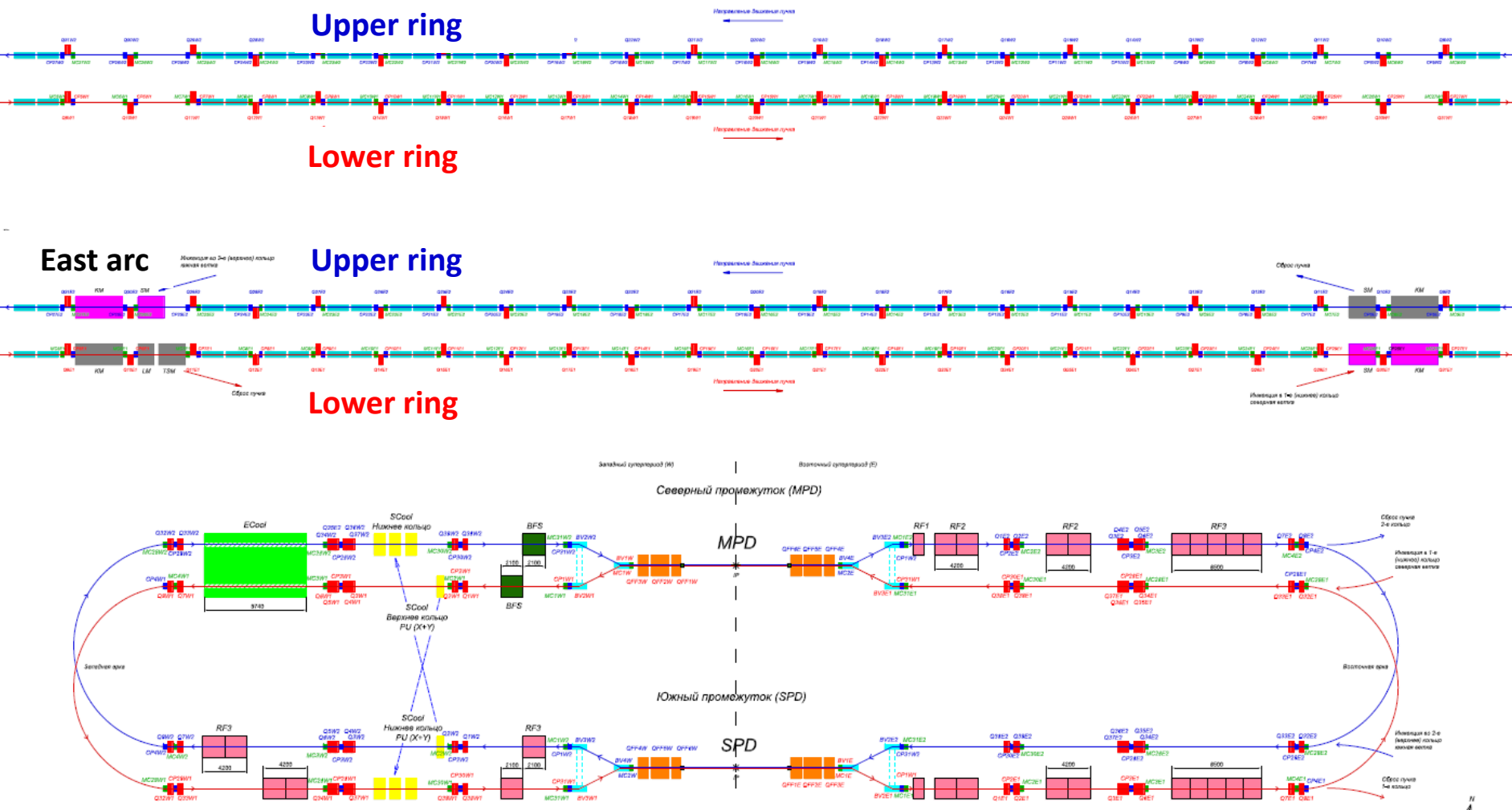

Q1 - Q39 - квадрупольные магниты L=470мм (Q9 - Q31 - находятся в арках)
 QFF1 - QFF6 - квадрупольные магниты финальной фокусировки пучков
 BV1 - BV4 - дипольные магниты вертикального сведения / разведения пучков
 MC1 - MC31 - мультиполюсные корректирующие магниты (MC5 - MC27 - находятся в арках, MC1, MC2 - общие для обоих пучков)

CP1 - CP31 - дипольные корректирующие магниты + мониторы положения пучка (CP5 - CP27 - находятся в арках)
 ECool - система электронного охлаждения
 RF1 - ВЧ-система 1
 RF2 - ВЧ-система 2
 RF3 - ВЧ-система 3
 BFS - система коррекции когерентных колебаний пучка
 Scool - кикеры системы стохастического охлаждения
 Scool PU (X+Y) - монитор положения пучка системы стохастического охлаждения



G.Khodzhibagiyan
S.Kostromin

NICA Collider Magnets

Characteristics	Dipole	Lens
Number of magnets	80+8*	86+12**
Max. magnetic field (gradient)	1.8 T	23.1 T/m
Effective magnetic length	1.94 m	0.47 m
Beam pipe aperture (h/v)	120 mm / 70 mm	
Distance between beams	320 mm	

8* - dipoles of two beams' convergence, 12 - Final Focus lenses**



“Cold” test at T = 4.5 K

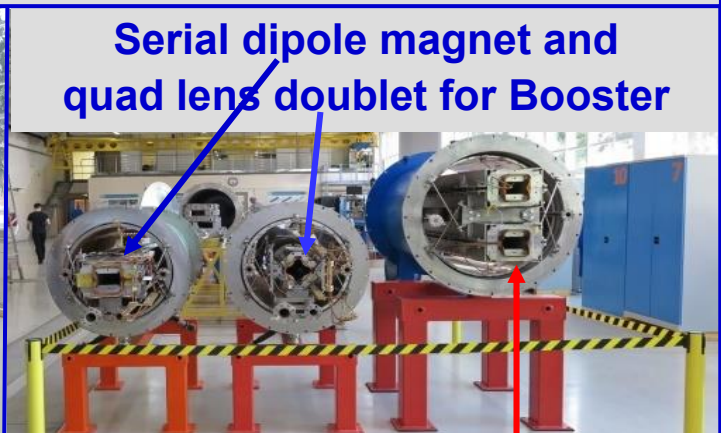

Serial dipole magnet and quad lens doublet for Booster

Preserial “twin” dipole magnet for Collider

Cooling Systems of The NICA Collider Magnets, Ions ¹⁹⁷Au⁷⁹⁺

HV Electron Cooler for NICA Collider
Stage of design and prototyping at BINP

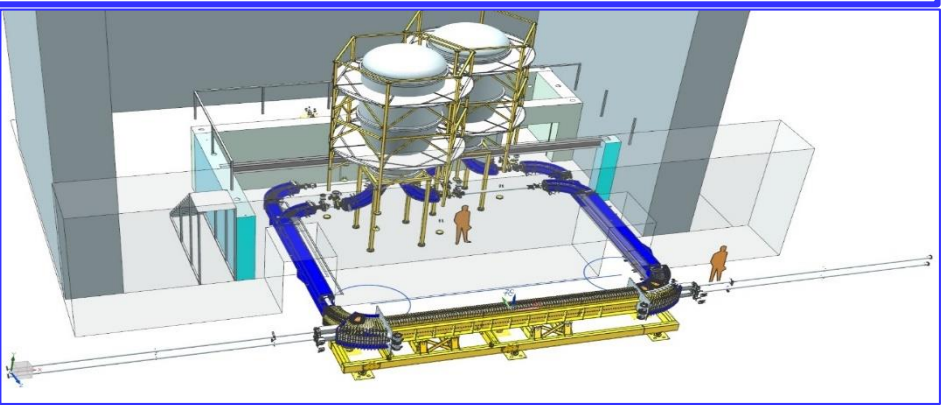

Main parameters

Parameter	Value
Electron energy, MeV Energy instability, $\Delta E/E$	0.2 – 2.5 $\leq 1 \cdot 10^{-4}$
Electron beam current, A	0.1 – 1.0
Cooling section length, m	6.0
Solenoid magnetic field, T Field inhomogeneity, $\Delta B/B$	0.05 – 0.2 $\leq 1 \cdot 10^{-5}$

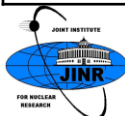

Cooling Systems of The NICA Collider Magnets, Ions ¹⁹⁷Au⁷⁹⁺

HV Electron Cooler for NICA Collider
Stage of design and prototyping at BINP

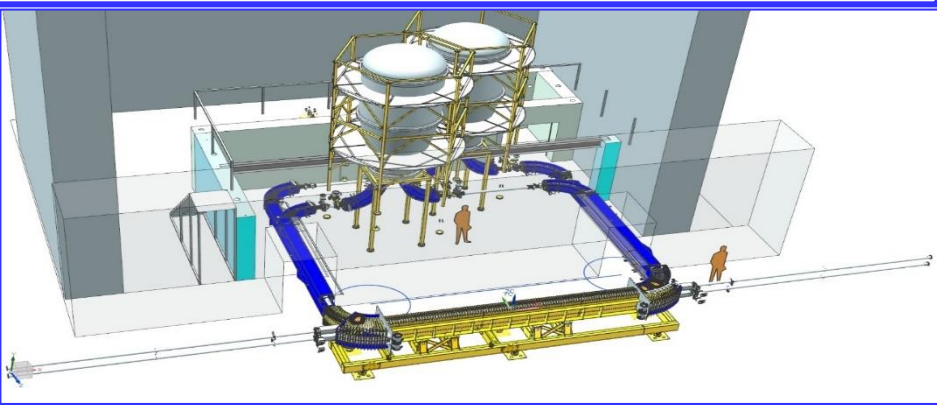

Main parameters

Parameter	Value
Electron energy, MeV	0.2 – 2.5
Energy instability, $\Delta E/E$	$\leq 1 \cdot 10^{-4}$
Electron beam current, A	0.1 – 1.0
Cooling section length, m	6.0
Solenoid magnetic field, T	0.05 – 0.2
Field inhomogeneity, $\Delta B/B$	$\leq 1 \cdot 10^{-5}$

Details have been presented in the the talk of Vladimir Reva (Tuesday, 11:30)

Cooling Systems of The NICA Collider Magnets, Ions $^{197}\text{Au}^{79+}$

HV Electron Cooler for NICA Collider
 Stage of design and prototyping at BINP

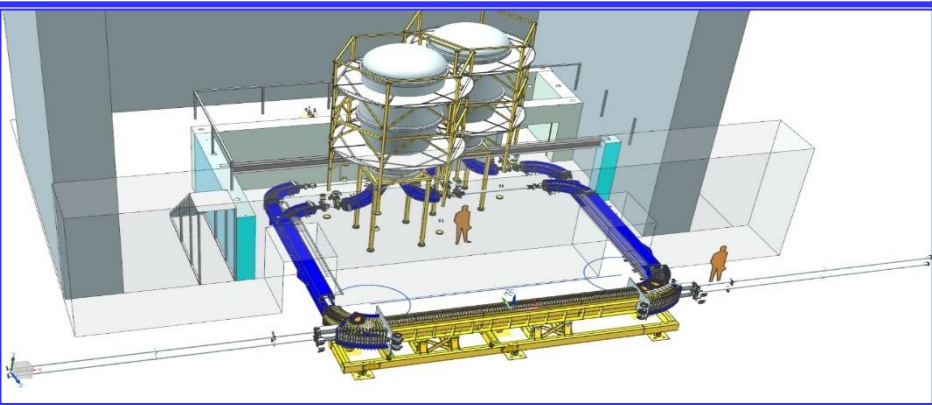

Main parameters

Parameter	Value
Electron energy, MeV	0.2 – 2.5
Energy instability, $\Delta E/E$	$\leq 1 \cdot 10^{-4}$
Electron beam current, A	0.1 – 1.0
Cooling section length, m	6.0
Solenoid magnetic field, T	0.05 – 0.2
Field inhomogeneity, $\Delta B/B$	$\leq 1 \cdot 10^{-5}$

Stochastic Cooling System for NICA Collider
 Stage of design and prototyping at JINR (?)

Facility configuration	Stage IIa (basic)	Stage IIb (final)
Energy range 3-4,5 GeV/u		
Bandwidth 2-4 GHz		
RMS bunch length, m	1,2	0,6
Cooling system	Longitudinal only	3-D
Method for long. cooling	Filter	Palmer
Optimal gain, dB	69	91
Equipment losses, dB	67	37
Total gain, dB	136	128

Details have been presented in the the talk of Vladimir Reva (Tuesday, 11:30)

Cooling Systems of The NICA Collider Magnets, Ions $^{197}\text{Au}^{79+}$

HV Electron Cooler for NICA Collider
Stage of design and prototyping at BINP

Stage IIb (final)

HV Electron cooler built in
the NICA Collider tunnel...

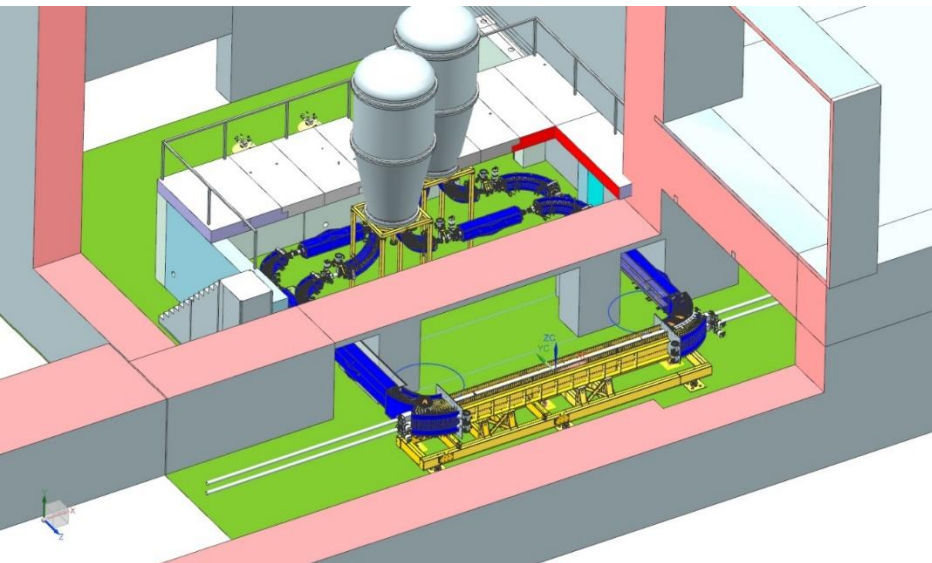

...in 2021 hopefully
(Stage IIb – final)

Stochastic Cooling System for NICA Collider
Stage of design and prototyping at JINR

FZJ Ring-slot couplers will be used
as Pickups & Kickers:

RS-LT system

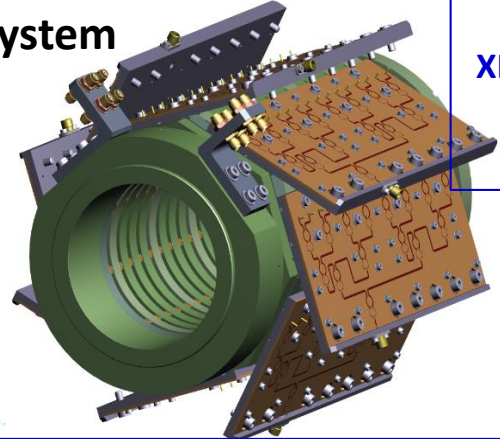

I.Gorelyshev (JINR)
Talk at
XII Sarantsev seminar
05.09.2017
Alushta, Crimea

G.Trubnikov,
A.Sidorin,
R.Stassen,
I.Gorelyshev

Stage IIa – basic configuration:
1 PU station and 1 kicker per ring

Stage IIb – final configuration:
3 PU stations and 2 kickers per ring (1 kicker
combines x- and s- co-ordinates)

Ion Storage in Collider Rings with Barrier Bucket Technique

BETACOOOL simulation with electron cooling: $E=1.5 \text{ GeV/u}$

Simulation of stochastic cooling: $E= 3.5 \text{ GeV/u}$

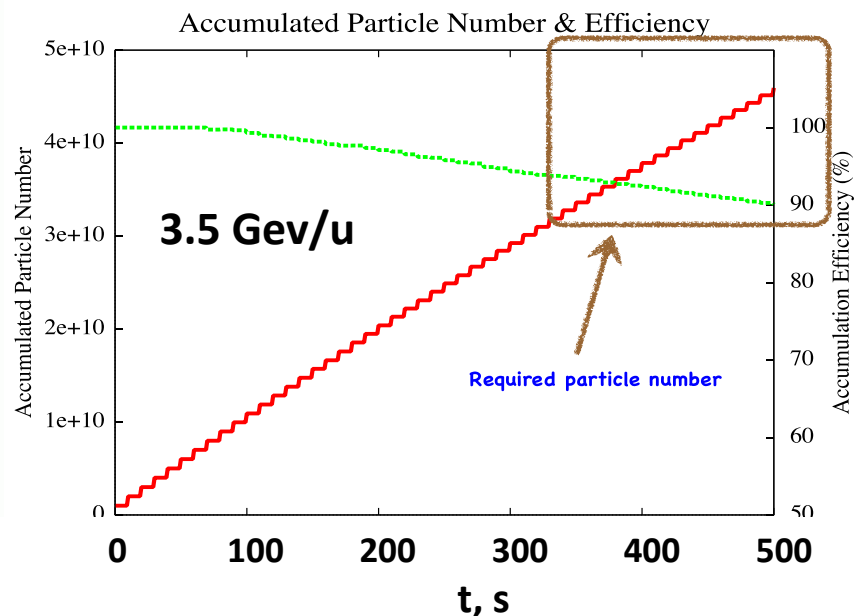
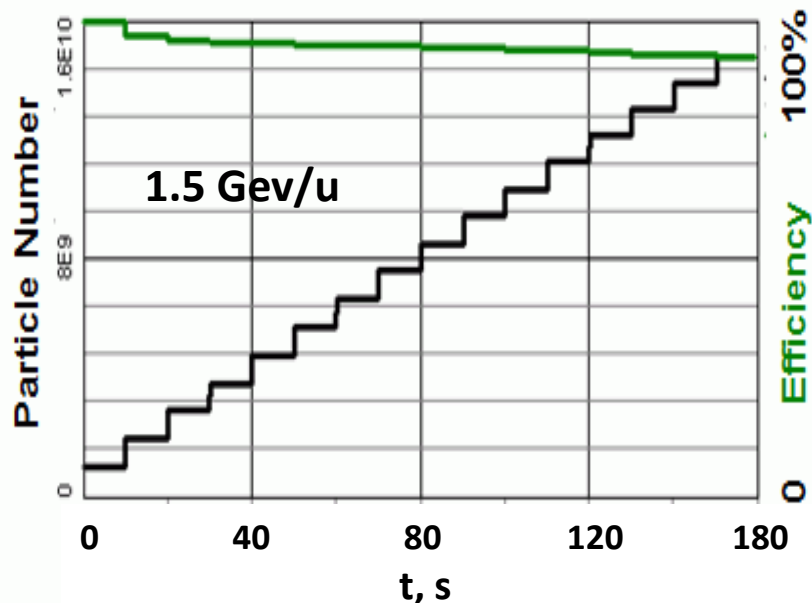

Accumulation process and its efficiency

$E < 3 \text{ GeV/u}$:

Stacking with Electron cooling

Storage time corresponds to 200 s at

ion energy 1-2.5 GeV/u

A.Smirnov, E.Syresin, 2016

$4.5 > E > 3 \text{ GeV/u}$:

Stacking with Stochastic cooling

T.Katayama, 2009

Project Luminosity of The NICA Collider and Strategy of Its Achievement and Maintenance

1. Efficient scheme of ion storage and formation of short bunches of the intensity up to $1e9$ ions $^{197}\text{Au}^{79+}$.
2. Vacuum in the Collider of the order of **10 pTorr** providing ion beam lifetime \sim **10 h**.
3. Compensation of ion beam space charge and suppression of intrabeam scattering (IBS) by means of electron and stochastic cooling application:
 $E_{\text{kin}} = 1 - 3 \text{ GeV/u}$ – electron cooling only,
 $E_{\text{kin}} = 3 - 4.5 \text{ GeV/u}$ – 3D both stochastic and electron cooling.
4. Suppression of coherent instabilities using feedback system.

All these measures allow us to form ion bunches
of the **r.m.s. length of 0.6 m**
that provides the Collider project luminosity.

RF Gymnastics in The Collider

Step 1: Cooling and stacking with RF1 barrier voltage (< 5 kV). Accumulation efficiency $\sim 95\%$, about 44 - 100 injection pulses (22-50 to each ring) every 5 sec. **Total accumulation time ≤ 10 min.**

Ion momentum spread is limited by microwave instability.

Steps 2-3. Formation of the short ion bunches at presence of cooling:

RF-2 (100 kV, 4 resonators) \Rightarrow RF-3 (1MV, 8 resonators).

From coasting beam to \Rightarrow 22nd harmonics \Rightarrow 66th harmonics

V_{RF} & ion
bunches ,
arb. units



Phase, arb. units

RF Gymnastics in The Collider

Step 1: Cooling and stacking with RF1 barrier voltage (< 5 kV). Accumulation efficiency $\sim 95\%$, about 44 - 100 injection pulses (22-50 to each ring) every 5 sec. **Total accumulation time ≤ 10 min.**

Ion momentum spread is limited by microwave instability.

Steps 2-3. Formation of the short ion bunches at presence of cooling:

RF-2 (100 kV, 4 resonators) \Rightarrow RF-3 (1MV, 8 resonators).

From coasting beam to \Rightarrow 22nd harmonics \Rightarrow 66th harmonics

V_{RF} & ion
bunches,
arb. units

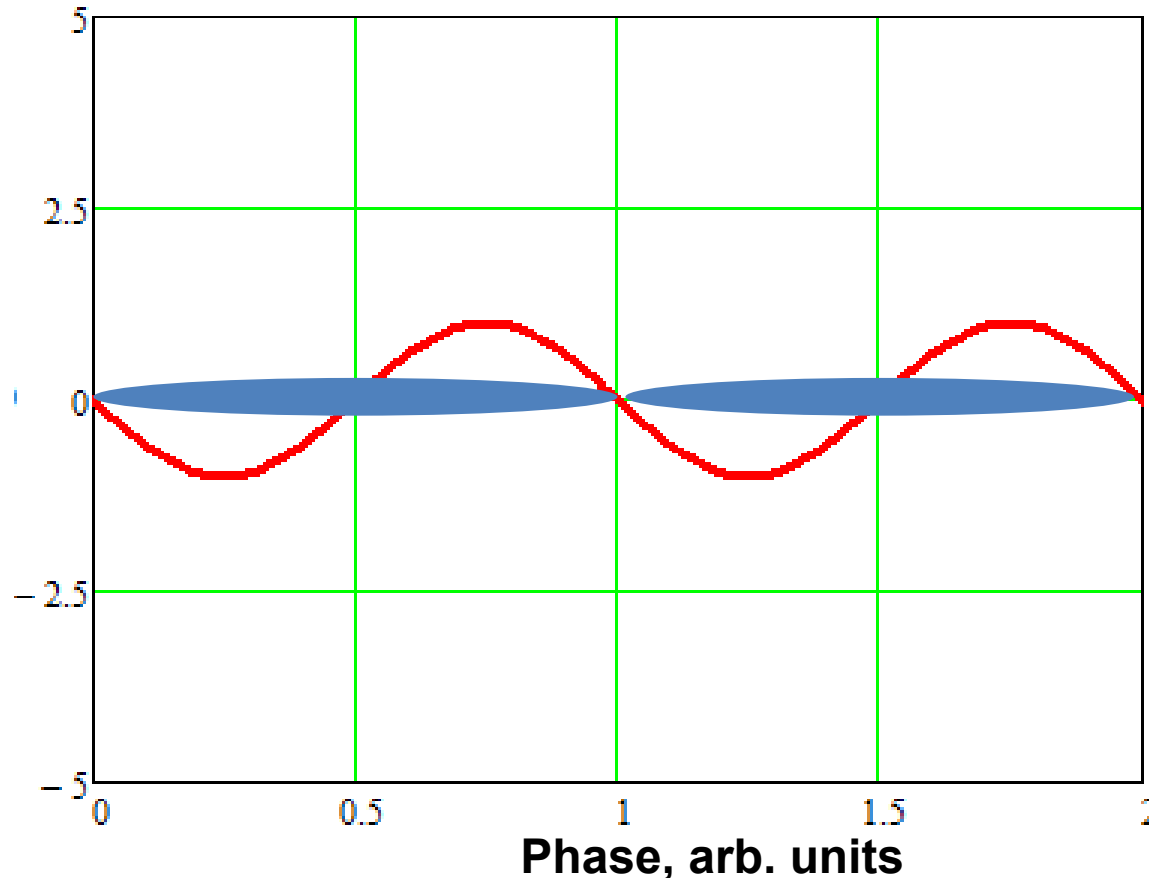

RF Gymnastics in The Collider

Step 1: Cooling and stacking with RF1 barrier voltage (< 5 kV). Accumulation efficiency $\sim 95\%$, about 44 - 100 injection pulses (22-50 to each ring) every 5 sec. **Total accumulation time ≤ 10 min.**

Ion momentum spread is limited by microwave instability.

Steps 2-3. Formation of the short ion bunches at presence of cooling:

RF-2 (100 kV, 4 resonators) \Rightarrow RF-3 (1MV, 8 resonators).

From coasting beam to \Rightarrow 22nd harmonics \Rightarrow 66th harmonics

V_{RF} & ion
bunches,
arb. units

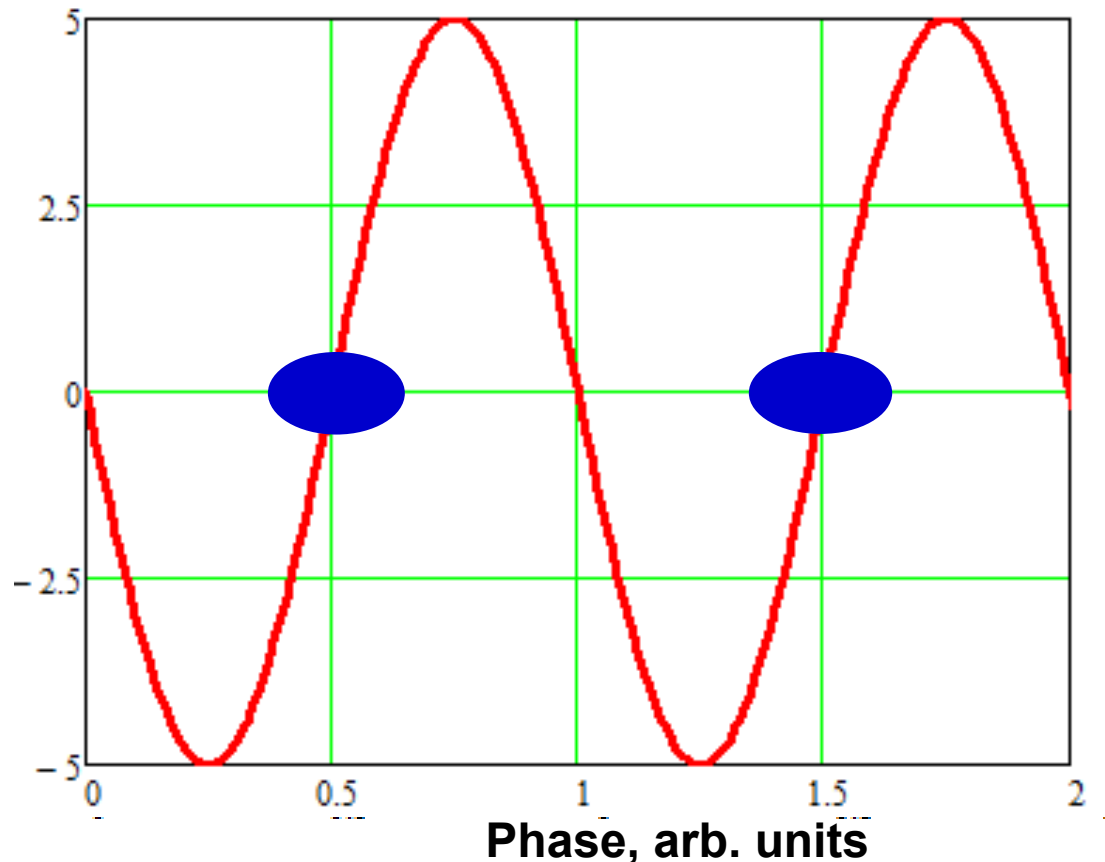

RF Gymnastics in The Collider

Step 1: Cooling and stacking with RF1 barrier voltage (< 5 kV). Accumulation efficiency $\sim 95\%$, about 44 - 100 injection pulses (22-50 to each ring) every 5 sec. **Total accumulation time ≤ 10 min.**

Ion momentum spread is limited by microwave instability.

Steps 2-3. Formation of the short ion bunches at presence of cooling:

RF-2 (100 kV, 4 resonators) \Rightarrow RF-3 (1MV, 8 resonators).

From coasting beam to \Rightarrow 22nd harmonics \Rightarrow 66th harmonics

V_{RF} & ion
bunches,
arb. units

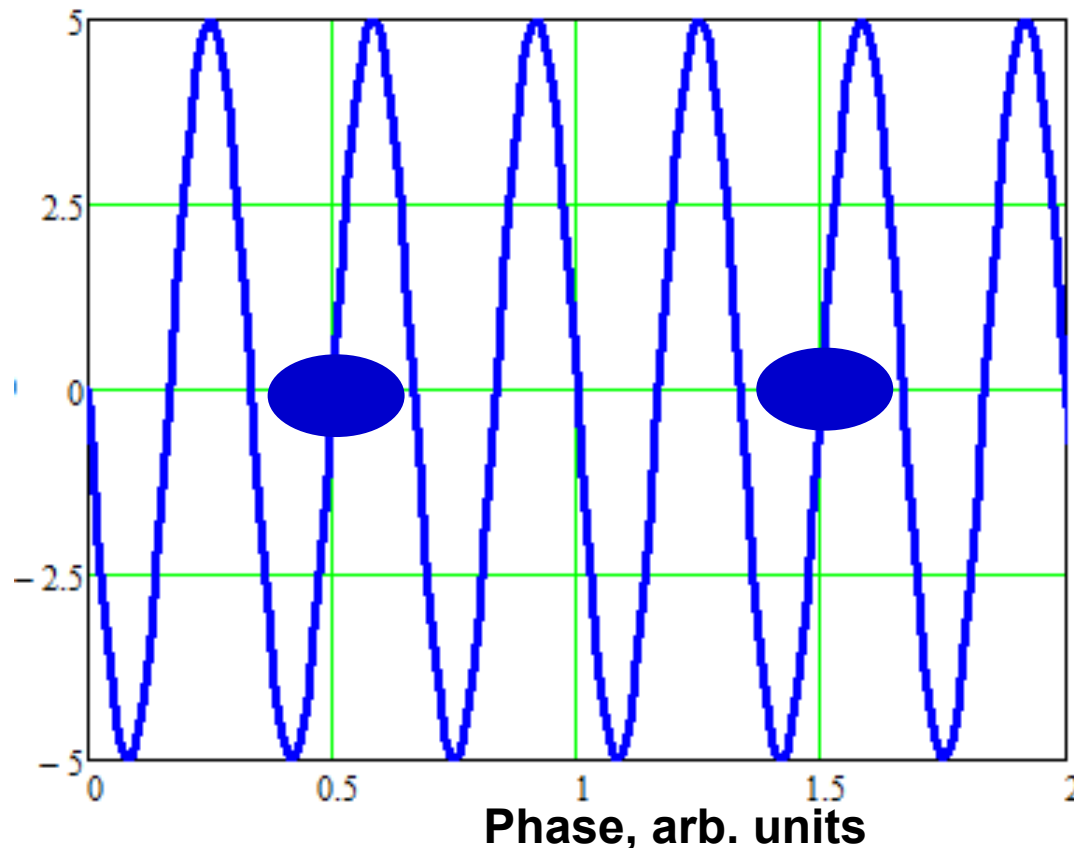

RF Gymnastics in The Collider

Step 1: Cooling and stacking with RF1 barrier voltage (< 5 kV). Accumulation efficiency $\sim 95\%$, about 44 - 100 injection pulses (22-50 to each ring) every 5 sec. **Total accumulation time ≤ 10 min.**

Ion momentum spread is limited by microwave instability.

Steps 2-3. Formation of the short ion bunches at presence of cooling:

RF-2 (100 kV, 4 resonators) \Rightarrow RF-3 (1MV, 8 resonators).

From coasting beam to \Rightarrow 22nd harmonics \Rightarrow 66th harmonics

V_{RF} & ion
bunches,
arb. units

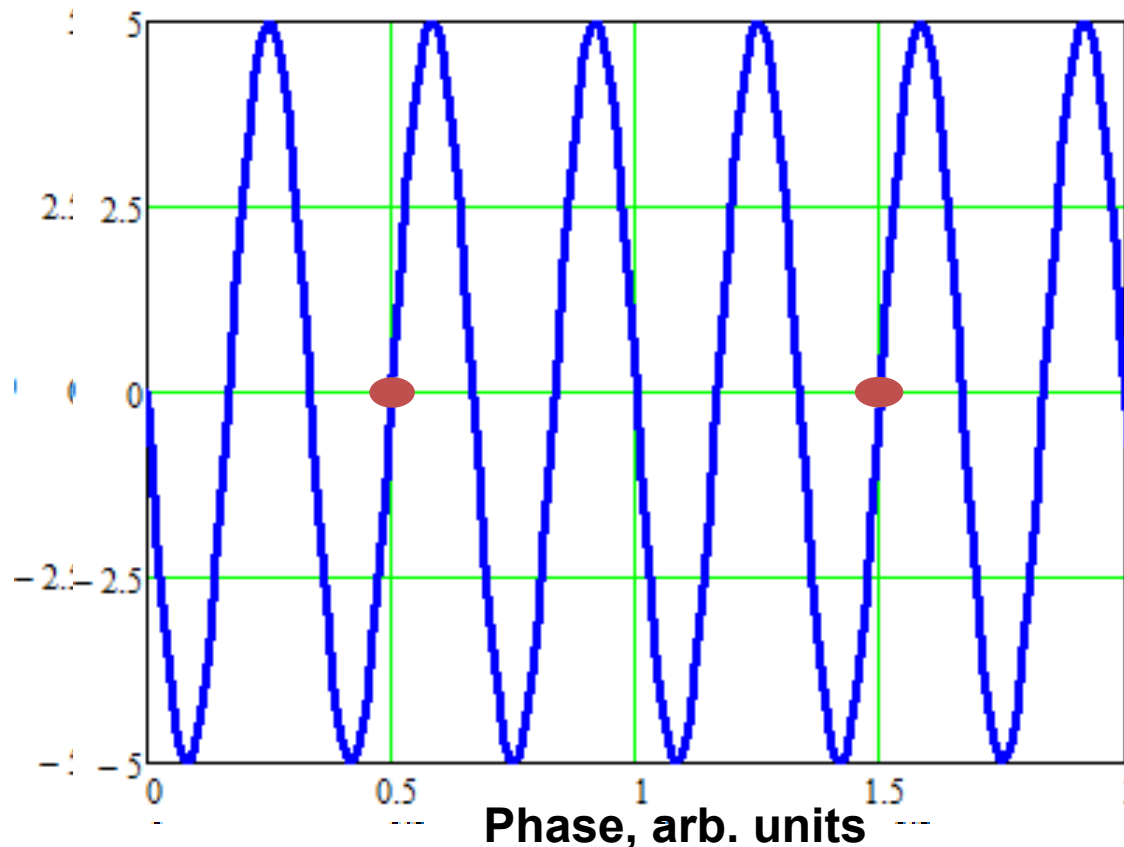

Beam Maintenance in Collider Rings with Cooling Technique

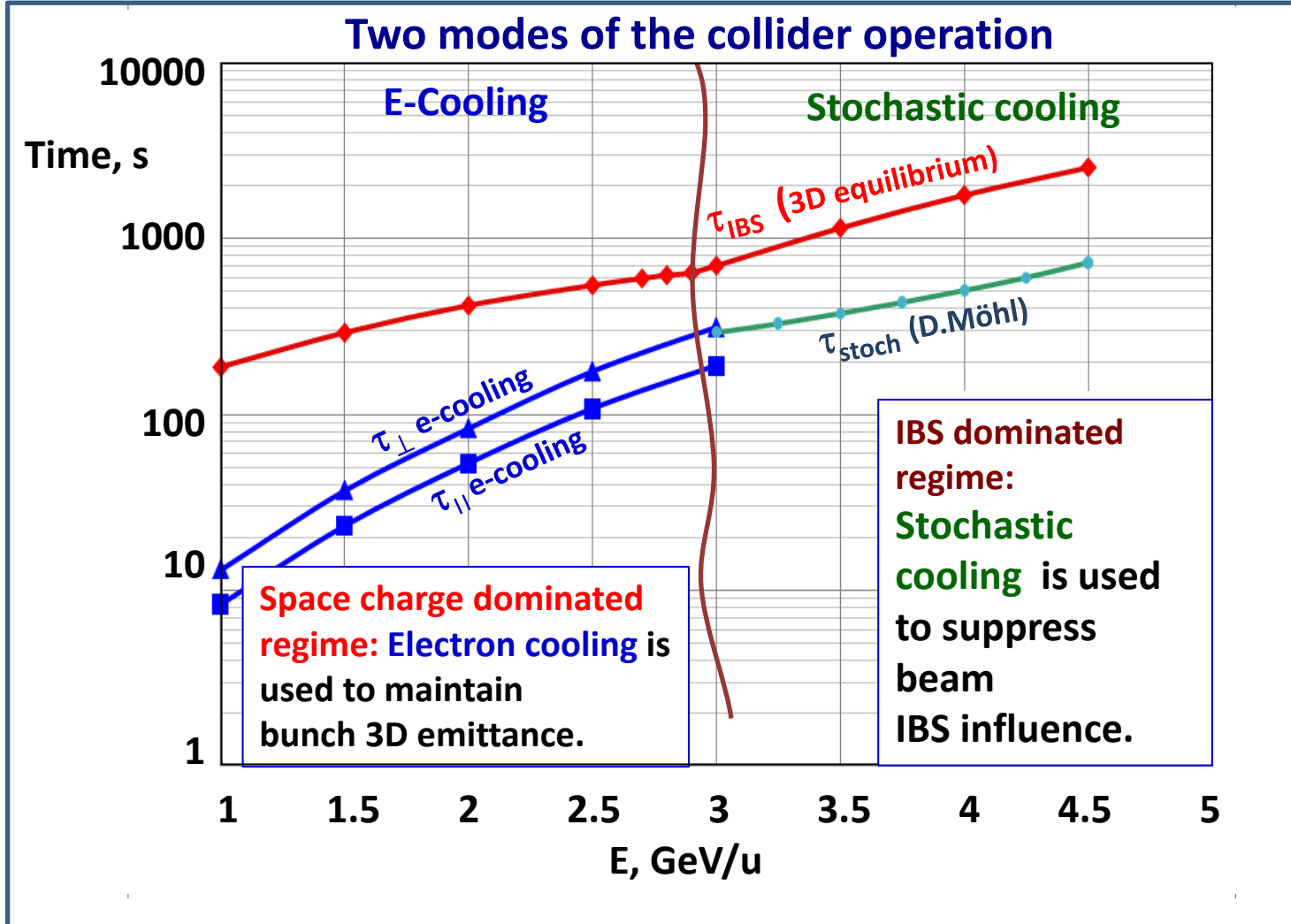

Space charge dominated mode ($\Delta Q \leq 0.05$)	IBS dominated mode
<p>ϵ and dp/p are optimized independently. The bunch <u>relaxation?</u> is suppressed by cooling. Luminosity is limited by space charge effects</p>	<p>ϵ and dp/p are “equi-partitioned”, either fast bunch relaxation. Luminosity can be obtained at small $\Delta Q < 0.05$</p>

Beam Maintenance in Collider Rings with Cooling Technique

Two Operation Regimes and Collider Luminosity

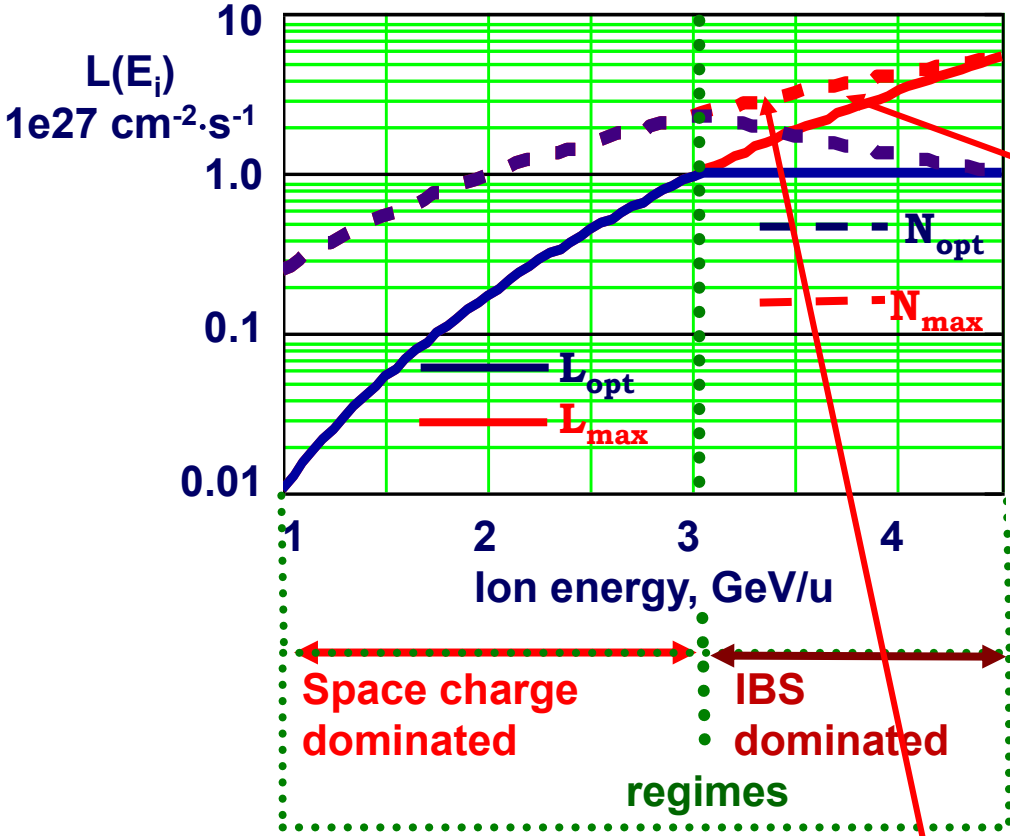

Electron and stochastic cooling application!
Emittance reduction with energy:...

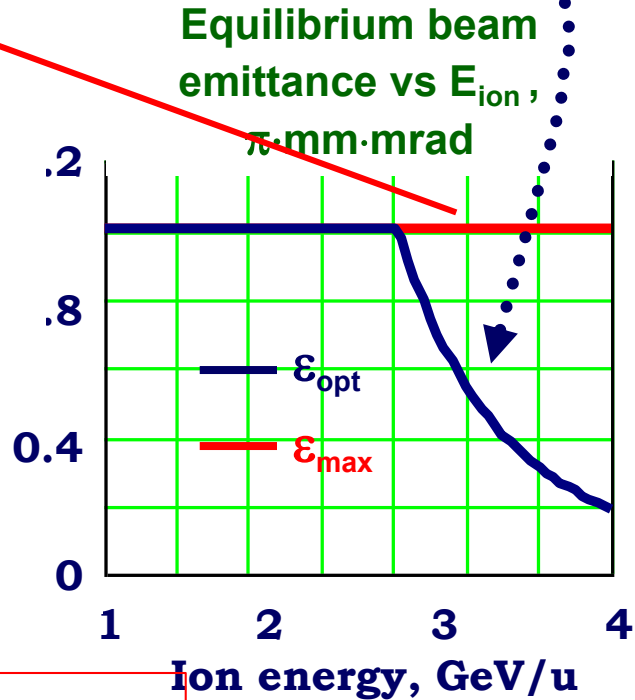

One can increase luminosity if... we can have at injection and storage more ions!



MultiPurpose Detector (MPD)

3 stages of The MPD Construction and Commissioning

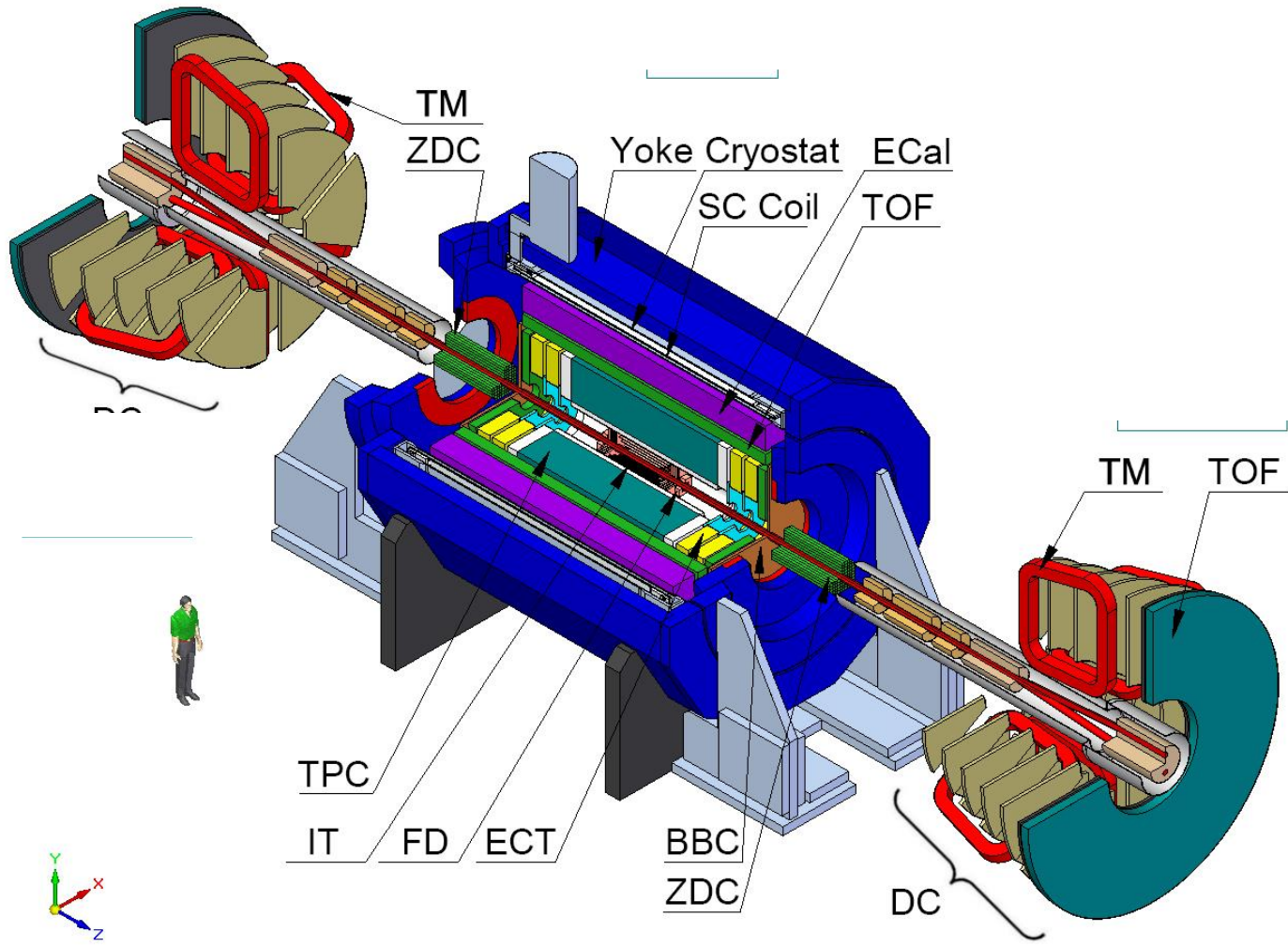

MultiPurpose Detector (MPD)

3 stages of The MPD Construction and Commissioning

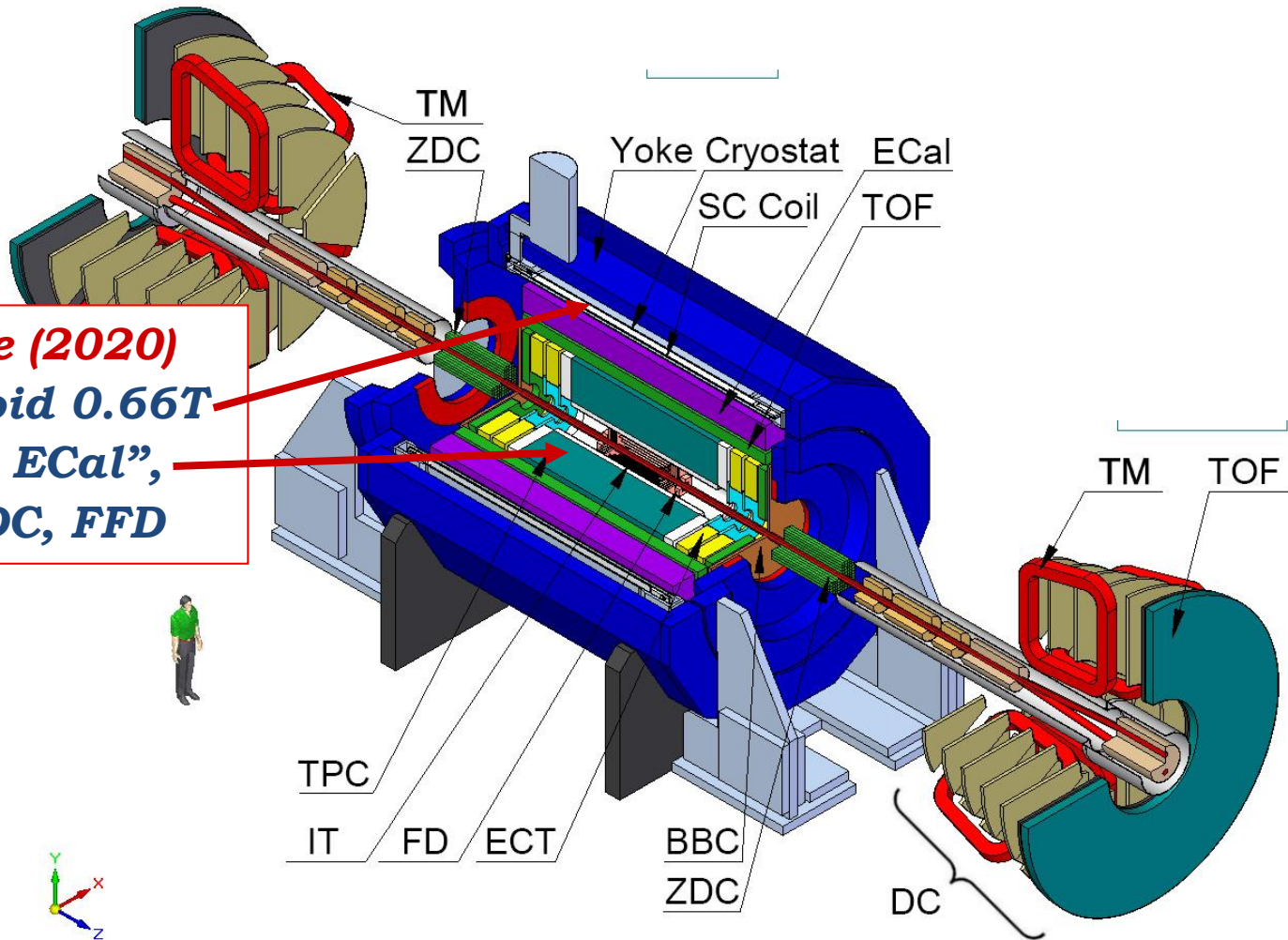

1st stage (2020)
SC solenoid 0.66T
“Barrel ECal”,
TPC, ZDC, FFD

MultiPurpose Detector (MPD)

3 stages of The MPD Construction and Commissioning

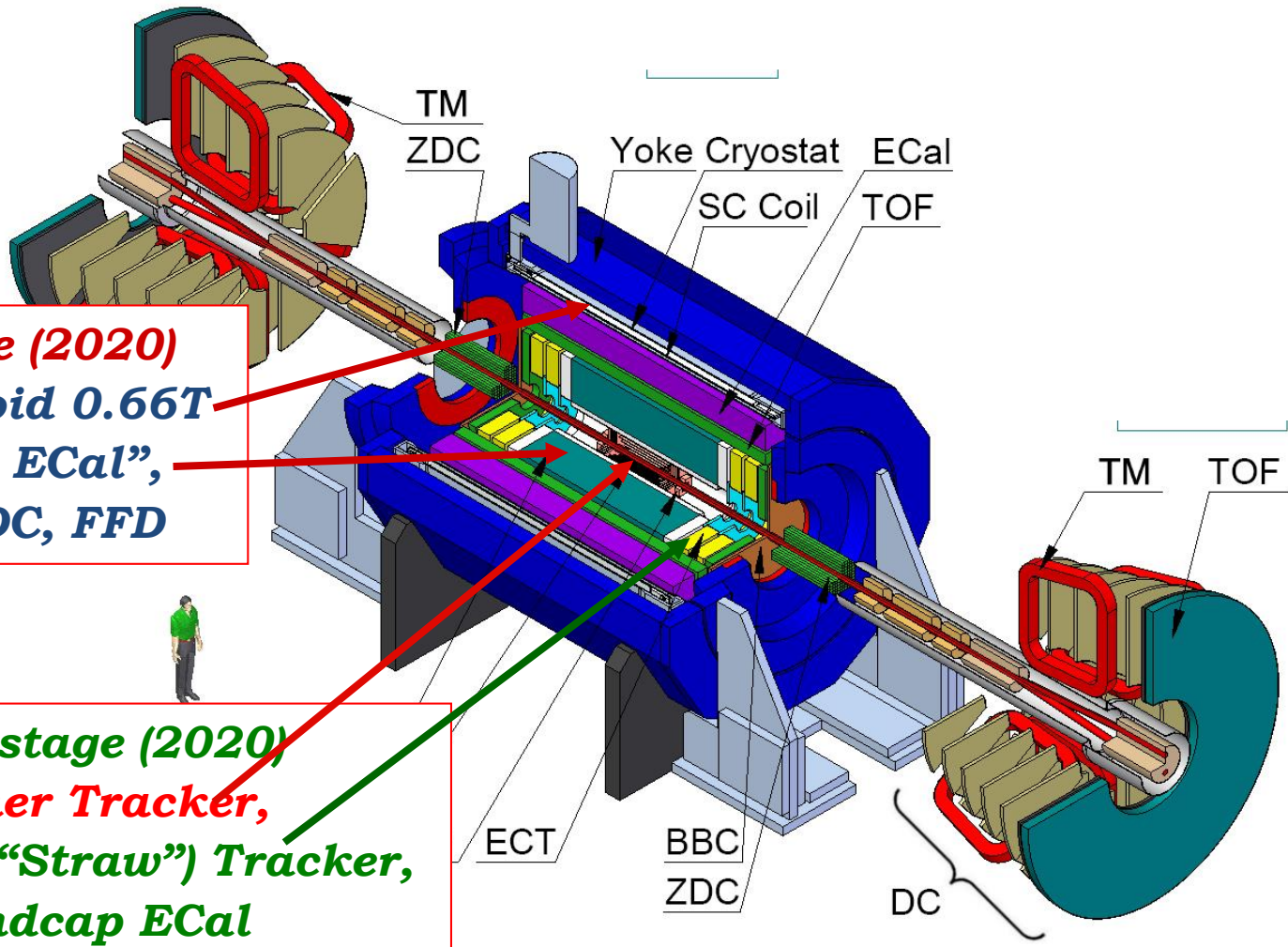

1st stage (2020)
SC solenoid 0.66T
"Barrel ECal",
TPC, ZDC, FFD

2nd stage (2020)
Inner Tracker,
EndCap ("Straw") Tracker,
Endcap ECal

MultiPurpose Detector (MPD)

3 stages of The MPD Construction and Commissioning

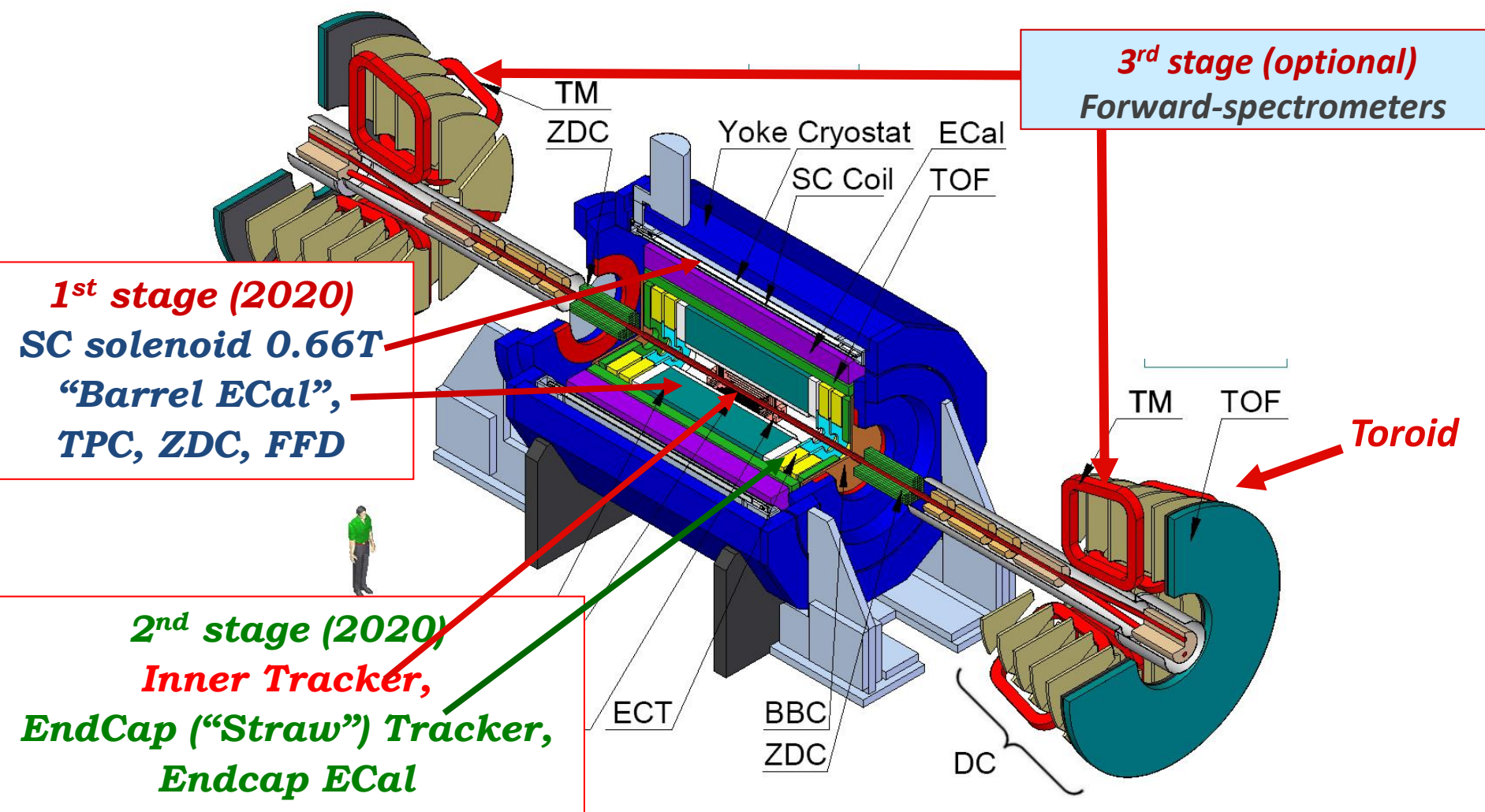

MultiPurpose Detector (MPD)

SC solenoid:
 $B_{sol} = 0.66 \text{ T}$
 Cryostat
 and SC winding
 Joke

"Barrel
 Ecal"

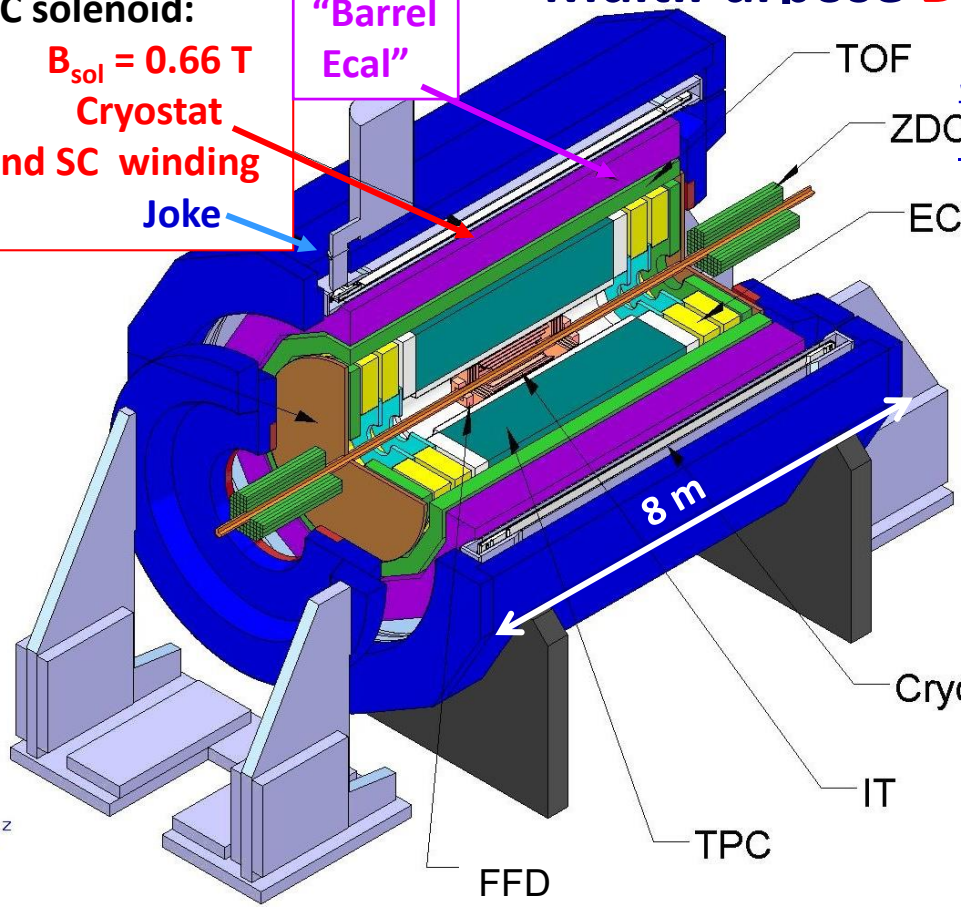

Subdetectors & probes' identification:

Particle Tracking:

- * Time projection chamber (TPC)
- * Inner tracker (IT)
- * End Cap Tracker (ECT)

Particle identification:

- * Time-of-flight detector (TOF)
- * Electromagnetic calorimeter (Ecal)
- * Time projection chamber (TPC)

Triggering (T0)

- * Fast Forward Detector (FFD)

Identification of centrality and event plane:

- * Zero Degree Calorimeter (ZDC)

MPD max. counting rate = 7 kHz

Stage II: Search for The Mixed Phase and New Physics In Heavy Ions' Collisions at NICA Collider

MultiPurpose Detector (MPD) – Construction Progress

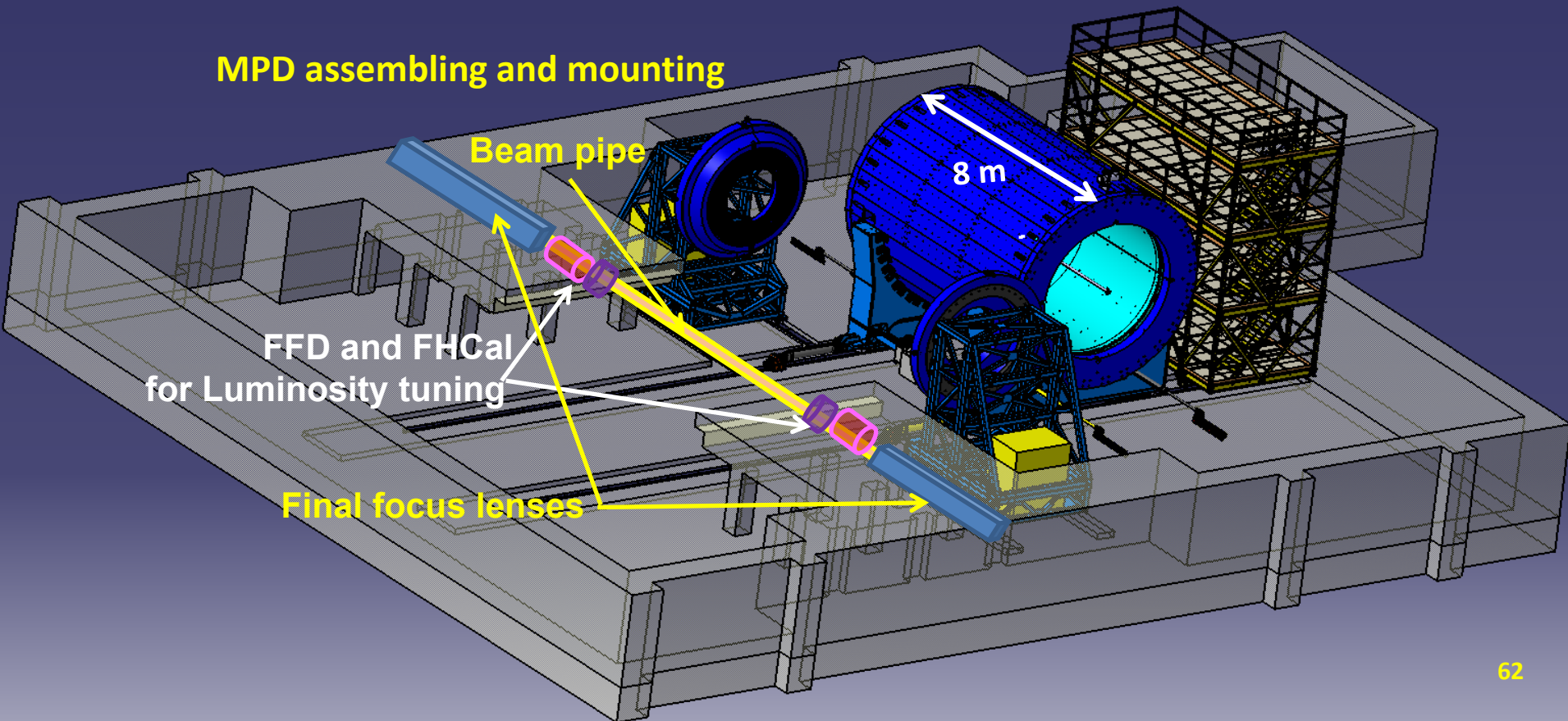
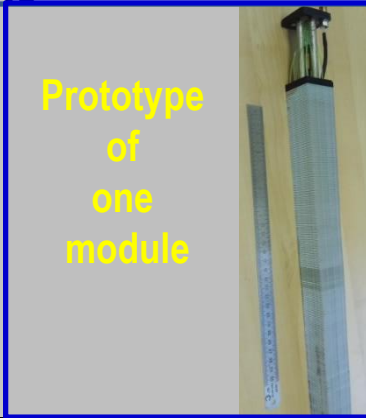
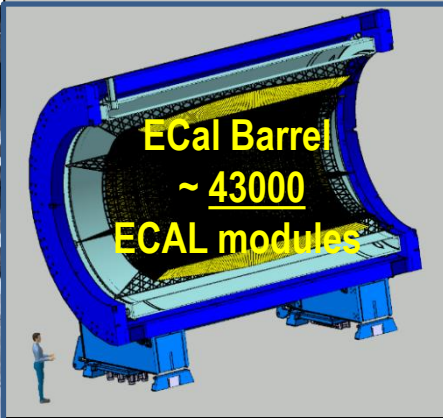

MPD Superconducting Solenoid

ASG superconducting C° (Genova, Italy):

- *Cold Mass + Cryostat*
- *Vacuum System*
- *Trim Coils*
- *Control System & Power Supplies*
- *General responsibility*

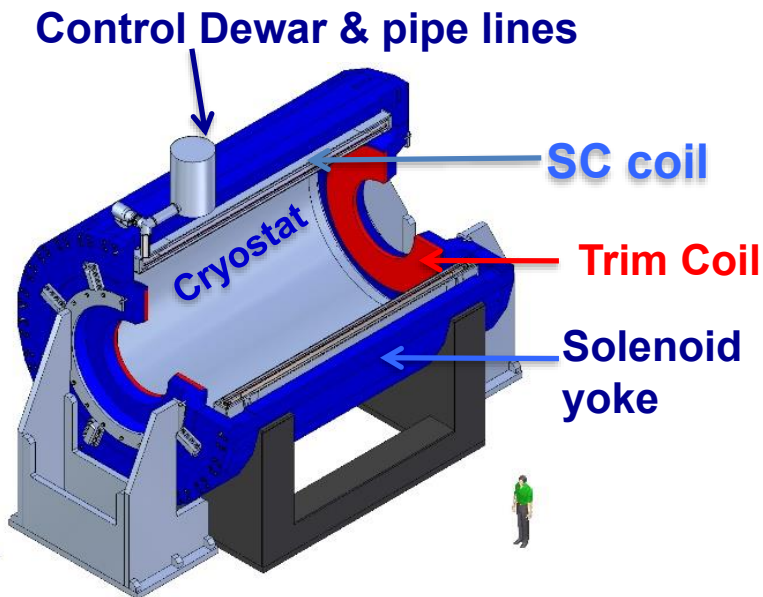

$$B_0 = 0.66 \text{ T}$$

$$\Delta B/B \leq 1e-4 \text{ in TPC area}$$

Weight ~ 900 t

Subcontractor: Vitkovice Heavy Machinery
(Vitkovice, Czech Republic)

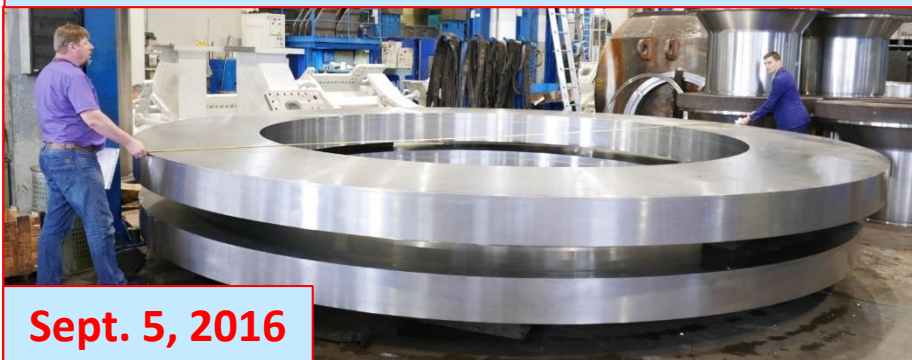

The Stage II will be completed in Two Stages:

NICA Stage II-a (basic configuration):

1. Collider equipped with

- RF-1 (barrier voltage system) for ion storage
- RF-2 in a reduced version: 2 cavities per ring instead 4 (50 kV RF amplitude instead 100 kV)
- 1 channel of S-cooling system per ring (cooling of longitudinal degree of freedom)

Result: 22 bunches of the length $\sigma \sim 2$ m per collider ring that gives $L \geq 5e25$ cm⁻²·s⁻¹.

2. MPD equipped without

- Inner tracker
- Forward spectrometers

NICA Stage II-b (full configuration):

Collider

- ❖ RF-2 systems in the project version
- ❖ RF-3 systems in the project version
- ❖ S-cooling (transverse)
- ❖ E-cooling

Result: 22 bunches of the length $\sigma \sim 0.6$ m per collider ring that gives $1e27$ cm⁻²·s⁻¹.

MPD:

- ❖ Inner tracker systems
- ❖ Forward spectrometers (?)

Stage III: Collider of Polarized Particles

$$\sqrt{s_{NN}} = 14 - 27 \text{ GeV polarized } p\uparrow \text{ (d}\uparrow\text{) at } L \leq 10^{32} \text{ cm}^{-2}\cdot\text{s}^{-1}$$

Accelerator facility:

1st concept of the *polarized colliding beams in NICA* has been developed by JINR group, but strongly criticized.

Group of experts from BINP has been invited to develop the project independently and agreement has been achieved in July 2017.

Detector:

Concept of the Spin Physics Detector (SPD) is under development during several years, however no concrete (final) version has been formulated.

Stage III: Collider of Polarized Particles

$$\sqrt{s_{NN}} = 14 - 27 \text{ GeV polarized } p\uparrow (d\uparrow) \text{ at } L \leq 10^{32} \text{ cm}^{-2}\cdot\text{s}^{-1}$$

Accelerator facility:

1st concept of the *polarized colliding beams in NICA* has been developed by JINR group, but strongly criticized.

Group of experts from BINP has been invited to develop the project independently and agreement has been achieved in July 2017.

Detector:

Concept of the Spin Physics Detector (SPD) is under development during several years, however no concrete (final) version has been formulated.

“August putsch”

August 17, 2017

First meeting for “NICA-polarized” has been performed:

1. Two concepts of the Spin Physics Detector (SPD) were presented.
2. SPD group coordinator and coordinators of subgroups were appointed.

Preparation of SPD CDR is in progress...

Formation of SPD collaboration was started.

Stage III: Collider of Polarized Particles

Final view of the NICA

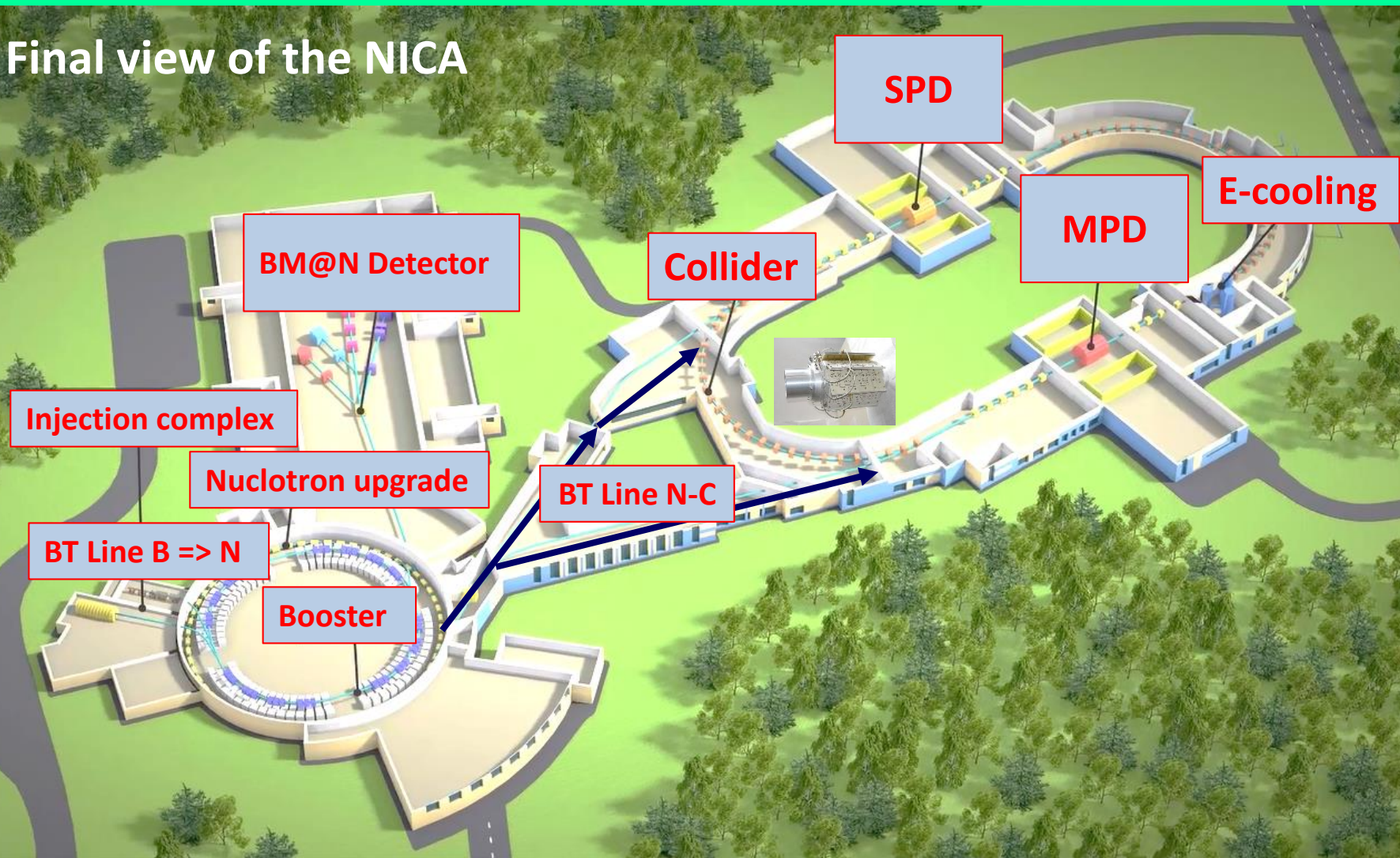



NICA Collider Building Construction



November 21, 2013



June 22, 2015

Graticule marking,
earth bores drilling



October 28, 2016



January 10, 2017



May 23, 2017

NICA MAC members visiting construction site

NICA Collider Building Construction

August 25, 2017



NICA Milestones

Component	Developer/Producer	Commissioning date
NICA Stage I (BM@N)		
1. Heavy ion source KRION	VBLHEP JINR	November 2018
2. HILAc	BEVATECH+VBLHEP JINR	Commissioned (2016)
3. Booster synchrotron	VBLHEP JINR	December 2018
3.1. RF system	BINP	Ready for mounting
3.2 E-Cooler for Booster	BINP	Ready for mounting
4. BTL Booster—Nuclotron	BINP	February 2019
5. BTL Nuclotron—BM@N upgrade	VBLHEP JINR	February 2019
6. BM@N experiment with Au ⁷⁹⁺	VBLHEP JINR	November 2019
NICA Stage IIa (Basic configuration)		
7. Nuclotron upgrade, fast extraction	VBLHEP JINR	November 2019
8. BTL Nuclotron—Collider	SigmaPhi (France)	1 December 2019
9. Collider – Stage IIa	VBLHEP JINR	December 2020
9.1. RF systems		
RF-1	BINP	December 2020
RF-2 (2 RF stations per ring)	BINP	December 2020
9.2. Stochastic cooling (1 Channel/ring)	BINP	December 2020 December 2020
3. Beam dump system	VBLHEP JINR	December 2020

NICA Milestones

NICA Stage IIb (Project configuration)		
11. Collider – Stage IIb	VBLHEP JINR	July 2023
11.1. RF systems		
RF-2 (2 RF stations per ring)	BINP	October 2022
RF-3 (8 RF stations per ring)	BINP/INR RAS (?)	October 2022
11.2. Stochastic cooling 2 channels per ring	VBLHEP JINR/Izhevsk C^o	October 2022
11.3. Electron cooler	BINP	October 2022
11.4. Feed back system 1 channel per ring	VBLHEP JINR	October 2022
12. MPD – NICA Stage IIb	VBLHEP JINR	December 2022

NICA Stage IIb (project configuration)	2023
---	-------------

NICA Stage III (polarized beams and spin physics)	2025
--	-------------

Status of The NICA Project

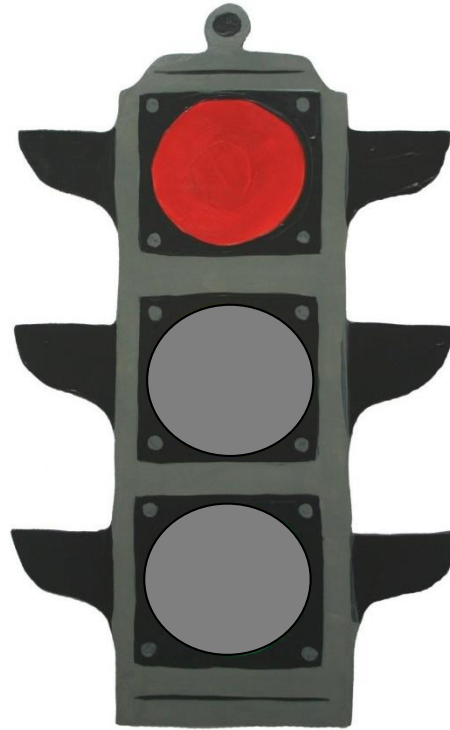

2008 Project beginning

Status of The NICA Project



2008 Project beginning

**2012 Active, but slow
phase**

Status of The NICA Project

April 27, 2016 – NICA Megaproject

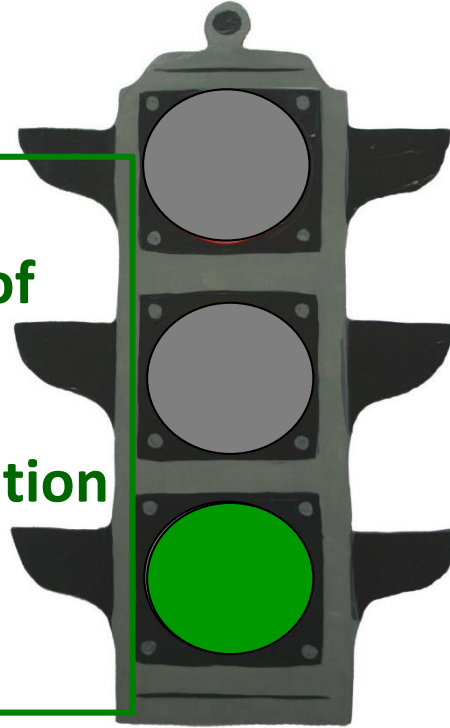

April 27, 2016
Order of The Government of
Russian Federation
₽ 8.8 billion Russian Federation
+
₽ 8.7 billion JINR

2008 Project beginning

2012 Active, but slow
phase

2016 NICA must be
built!

Status of The NICA Project

April 27, 2016 – NICA Megaproject

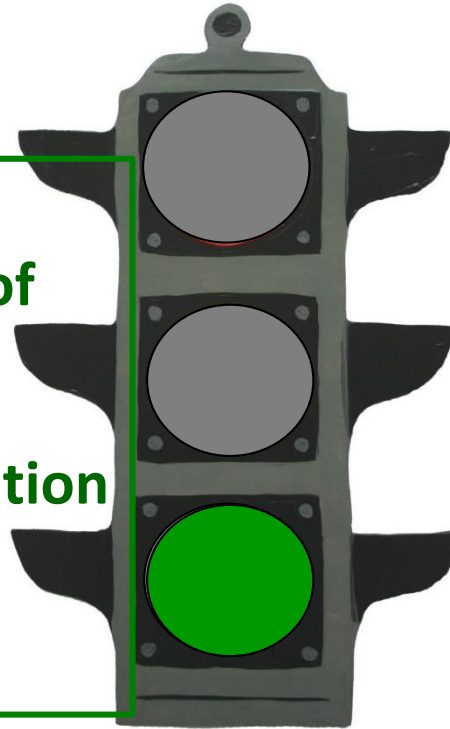

2008 Project beginning

2012 Active, but slow phase

2016 NICA must be built!

April 27, 2016

Order of The Government of Russian Federation

₽ 8.8 billion Russian Federation

+

₽ 8.7 billion JINR

ACKNOWLEDGEMENT

Authors express the gratitude to the colleagues of the NICA accelerator team – *A.Butenko, G.Khodzhibagiyan, T.Katayama, S. Kostromin, O.Kozlov, A.Sidorin, A.Smirnov, R.Stassen, E.Syresin, A.Philippov, and A.Tuzikov* - for longstanding intense common work on the NICA project and (I.M.) to E.Levichev (BINP) for fruitful advises on nonlinear particle dynamics in cyclic accelerators.

August 25, 2017

Thank you for your attention!

