

# YTTERBIUM FIBER AND DISK LASER OF RF GUN FOR SUPERKEKB

X. Zhou, T. Natsui, M. Yoshida, Y. Ogawa, KEK, Tsukuba, JAPAN

## Abstract

For SuperKEKB project, the electron beams with a charge of 5 nC and a normalized emittance of 10  $\mu\text{m}$  are expected to be generated in the photocathode RF gun at the injector linac. An ytterbium (Yb)-doped laser system with a center wavelength of 259 nm and a pulse width of 30 ps is employed to obtain high peak energy pulses. Although, the pulse repetition of 25 Hz with double-bunch is required, more than 5 nC electron with single-bunch has so far been generated in the 2 Hz.

## INTRODUCTION

In SuperKEKB project, the photocathode RF gun for high-current, low-emittance beams will be employed in the injector linac to obtain higher luminosity [1]. Corresponding to 5 nC and a normalized emittance of 10  $\mu\text{m}$  in the photocathode RF gun [2], the laser source with 1 mJ pulse energy, center wavelength of 259 nm and a pulse width of 30 ps are developed.

In more recent years, both fiber lasers and thin-disk lasers are expected to show significant further progress. The fiber laser offers higher amplify efficiency, simple configuration, good stability and low-cost. And the thin-disk laser optimizes heat removal, which makes possible the high energy pulse amplifier. For SuperKEKB project, the laser source structure of RF gun was designed as a hybrid system, which include an Yb-doped fiber oscillator, Yb-doped fiber amplifiers and thin-disk Yb:YAG amplifiers.

For the repetition rate of electron beam, the 2 Hz, 5 Hz, and 25 Hz with double bunches were requested. Firstly, the laser system was tested in 2 Hz. After that, the laser was upgraded to 25 Hz.

In the ref [3], the 0.7 nC electron beam was obtained with Yb laser source last year. For higher energy generation, the laser structure was reformed.

A schematic diagram of the laser setup is shown in Fig.1. The seed pulse was generated by an Yb-doped fiber ring oscillator. Then the pulse repetition is reduced to 10.38 MHz by an EO fiber pulse picker. After an Yb fiber pre amplifier to compensate for the power loss in EO system, the pulse was chirped to  $\sim 30$  ps by a transmission grating stretcher. An Yb-doped large-mode-area polarizing double-clad photonic crystal fiber was employed to the first amplification stage. Then, the pulse repetition rate (2 Hz and 5 Hz) was separated with an EO modulator pockels cell. To increase the pulse energy, another Yb-doped LMA PCF was used. So the pulse was strong enough to be amplified by Yb:YAG thin-disk stage. To obtain the mJ-class pulse energy, a regenerative amplifier and two multi-pass amplifier stages were employed. Deep UV pulses for the photocathode are generated by using two frequency-doubling stages. High pulse energy and good stability were obtained. Finally, the pulses were injected into RF gun.

## Reformed of Yb Fiber Oscillator

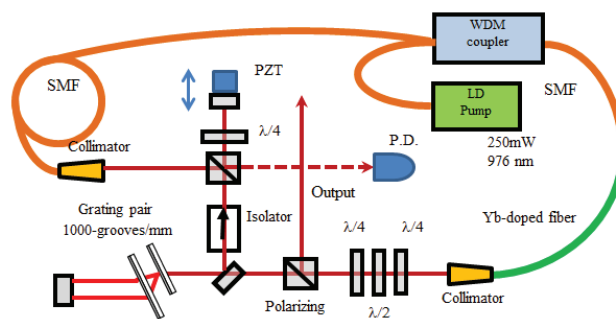

Figure 2: Oscillator.

## LASER SYSTEM OF 2HZ AND 5HZ

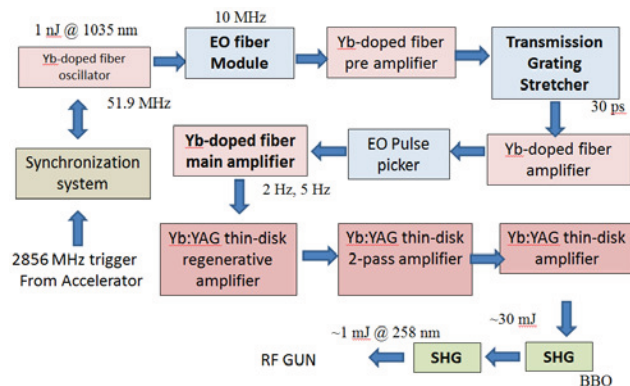

Figure 1: Layout of laser system.

A unidirectional ring cavity is employed in the passive mode-locked oscillator (Fig. 2). As the laser source creation, the stability of seed pulse is most important. To improve the property of the oscillator, some reforms were completed. Firstly, to reduce the thermal effect; a super-invar breadboard was used, which has a near zero coefficient of thermal expansion over a wide temperature range. Secondly, reflection gratings were replaced by a pair of transmission gratings. Because of the higher transport rate, the cavity loss was reduced, and the mode-locking is easy to be initiated. Finally, the piezoelectric transducer (PZT) that is used to control the cavity length to lock the repetition rate with the SuperKEKB, was attached to a lead block at an extra cavity. The space jitter was sharply reduced when the PZT is shaking to synchronization.

Content from this work may be used under the terms of the CC BY 3.0 licence (© 2014). Any distribution of this work must maintain attribution to the author(s), title of the work, publisher, and DOI.

The Oscillator was pumped by a fiber-coupled pump diode delivering 750 mW at 976 nm. Although, the higher pump power could create higher output power, the noise signal such as side peaks also occurs. Therefore, the pump power was controlled below 200 mW, with the average output power of 30 mW. The repetition rate is 51.9 MHz (10.38\*5 MHz), which is supplied by KEKB with the repetition rate of 2856 MHz. The mode-locked operation and synchronization system were stable for long time.

### Upgrade of Yb Fiber Amplifier Stages

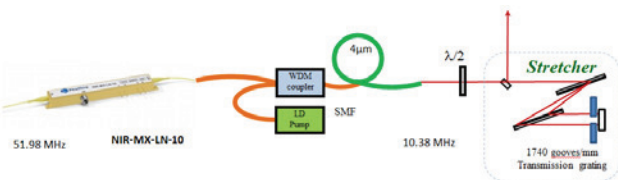

Figure 3: Pulse picker and stretcher.

Last time, the signal pulses of 51.9 MHz repetition rate were reduced to 2 Hz with an EO modulator pulse selector. The duration of pulse-to-pulse was ~ 20ns, which is short than the range of EO modulator possible pulse duration. The side pulses were remained before and after the main pulse. Therefore, an additional EO fiber pulse picker was employed to reduce the repetition rate to 10.38 MHz firstly. Then pulse-to-pulse duration was expanded more than 100 ns, which is easy to shield side pulses. Because the energy loss of the fiber EO modulator is more than 90%, an Yb fiber pre amplifier was set to compensate for the power loss. The pair of transmission gratings with a groove density of 1740 grooves/mm is used to stretch the pulse to several tens ps with an efficiency of 80%.

The gain spectrum of Yb:YAG is around 10 nm center at 1037 nm. By contrast, the pulse that is generated by Yb fiber has wide spectrum from 1020 nm to 1080nm. For matching the gain area of Yb:YAG disk and Yb-doped fiber, a spatial slit was performed for spectral shaping between the grating pair and reflector, where the spectrum is spatially separated with a parallel beam (Fig. 3).

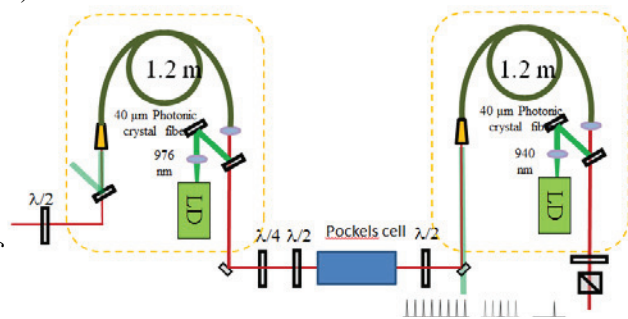

Figure 4: Yb-doped fiber amplifier.

The output of stretcher is seeded into the fiber amplifier by a large-mode-area polarizing double-clad photonic crystal fiber 1.2 m in length with a core diameter of 40

µm and pump clad diameter of 200 µm, which is cladding backwardly pumped by a 70 W fiber-coupled laser diode emitting at 976 nm.

An EO modulator pulse selector was employed to reduce the pulse repetition rate. The repetition rate can be set to 2 Hz and 5 Hz with double pulses. After reduction of the pulse repetition rate, another Yb-doped fiber amplifier was used for higher pulse energy. For stability, the amplifier is pumped with light at a wavelength of 940 nm. Although, the laser diode pump power could reach the 70 W in both fiber amplifiers, the DC background contained in the signal is also increased, which can be amplified in thin-disk amplifier stage. Thus, the pump power was conducted to low level. In this stage, the pulse was amplified to several µJ. See Fig. 4.

### Redesign the Thin-Disk Amplifier

The thickness of the Yb:YAG thin-disk crystal is 2 mm, which not fit for high energy capacity. To obtain the mJ-class pulse energy, a regenerative and a multi-pass Yb:YAG solid state amplifier was employed last year.

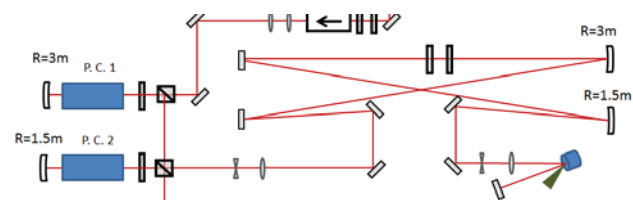

Figure 5: Thin-disk regenerative amplifier.

Double bunches means the duration of the two bunches is about 100 ns. Consider the response speed of the pockels cell (~20 ns), the total cavity length of the one round trip is about 36 m. The improvement of the amplifier started with restructuring the ring cavity to a linear cavity. Thus, the cavity length was reduced to 9 m. The two Pockels cells were used to control the entrance and exit times of the cavity respectively (Fig. 5).

Usually, the thin desk crystal acts as an end mirror within the laser resonator. Although the HR coating was performed in back surface of crystal, the multiple reflections occurred in front surface. As the fig. 5, another 0° high reflection mirror was used as an end mirror. And the signal beams pass through the thin-disk crystal two times in one round trip, which increases the efficiency of the regenerative amplifier.

A 2.4 kW laser diode, is employed as the pump source, with oblique injection into the Yb:YAG thin-disk crystal with a spherical mirror and a plano-convex cylindrical lens. The pulse energy was increased to more than 1 mJ, and the multi-pass amplifier was used for higher amplification.

For low repetition rate pumping as 2 Hz and 5 Hz, the thermal lens effect can be ignored. After a telescope collimator, parallel light beam was injected into a 2-pass amplifier and 1-pass amplifier (Fig. 6).

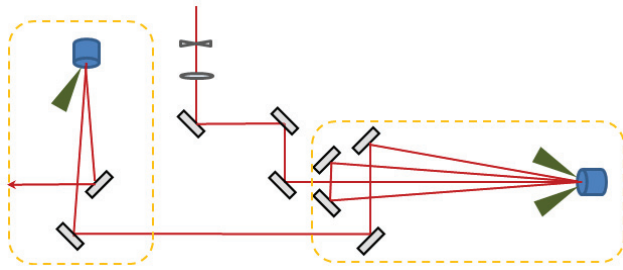

Figure 6: Thin-disk multi-pass amplifier.

The pump source is increased to 9.6 kW, with 4 laser diode setting around the Yb:YAG crystal. After the 2 stage amplifier, more than 20 mJ output pulse energy is obtained.

Deep UV pulses are generated by using two frequency-doubling stages. Two piece of 5 mm thickness beta barium borate (BBO) crystal are used to generate UV pulses at a center wavelength of 259 nm. Although the energy of fundamental beam is strong enough, the noise pulses and DC background exist in the signal pulses. The final UV pulse energy of 1.0 mJ was obtained in 2 Hz, and 0.6 mJ obtained in 5 Hz with the total SHG conversion efficiency of 5%. Fig. 7 shows the UV pulse shape in the time domain.

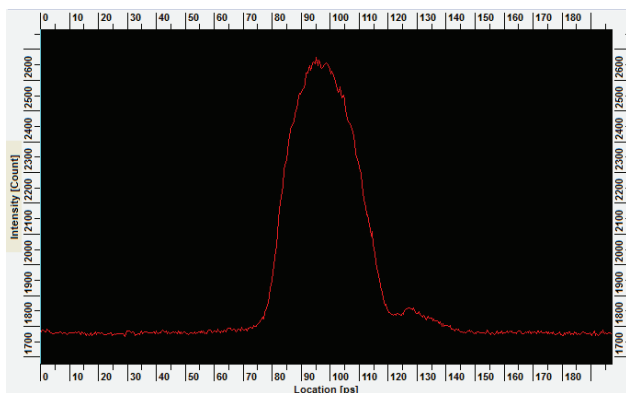

Figure 7: UV pulse profile.

### Laser Injection at RF Gun

The UV laser pulses are injected into the cathode in RF gun with the angle of 60°. As a result of RF gun beam measurement, 5.6 nC beam generation from the gun was achieved in 2 Hz. The RF-Gun cavity, cathode and experimental results will be shown in the ref [2].

### UPGRADE OF LASER SYSTEM TO 25HZ

When the repetition rate increases to 25 Hz, the condition of the laser amplifier system is changed seriously. First of all, the thermal lens effect cannot be ignored in the thin-disk amplifier stages. Secondly, the noise and background signal is obviously increased, which affect the quality of the laser source.

A schematic diagram of the restructure laser setup of 25 Hz is shown in Fig.8. Although the regenerative thin-

disk amplifier can provide effective amplification, the structure is too complex to maintain, which tie the stability of the all system down. Therefore, we try to use other amplifier replacing the regenerative amplifier. To increase the fiber amplifier stages, the stretcher was set between the oscillator and 10 MHz pulse picker. Thus, the pulse energy of fiber stages is strong enough to amplify directly by thin-disk multi-pass amplifier stages. After fiber amplifier, 3 multi-pass stages were performed. For compensate thermal lens effect, double lens was used in front of the thin-disk crystal. To improve the heat remove of the crystal, the disk thickness was reduced to 0.5 mm.

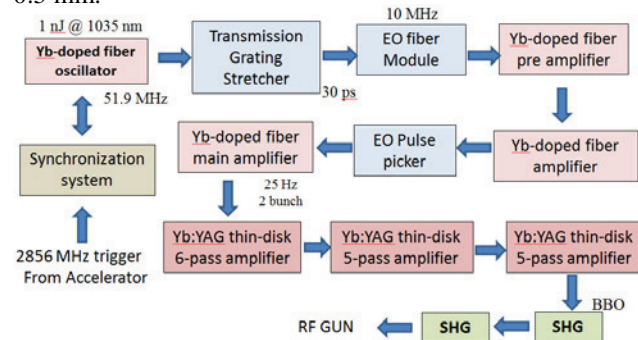

Figure 8: Layout of 25 Hz laser system.

More than 20 mJ fundamental pulse energy was obtained. From noise and background problem, the UV pulse was reduced to 400 μJ, and 0.8 nc electron beam was obtained.

### CONCLUSION

In SuperKEKB project, for obtaining high-current, low-emittance beams in the photocathode RF gun, the UV laser source with 1 mJ, 30 ps was developed. The hybrid laser system contains with a Yb-doped fiber-based oscillator, large mode-area Yb-doped fiber amplifier and thin-disk Yb:YAG amplifier systems.

In 2 Hz repetition rate setup, more than 1 mJ UV pulse was obtained. As the result, the electron beams with a charge of 5.6 nC was generated.

To overcome the thermal effect in 25 Hz repetition rate, the laser was reformed. 0.8 nC beam generation is achieved by the new laser source.

### REFERENCES

- [1] T. Miura et al., MOPRO001, IPAC14, Dresden, Germany, these proceedings.
- [2] T. Natsui et al., MOPRI033, IPAC14, Dresden, Germany, these proceedings.
- [3] X. Zhou, et al., WEPME061, IPAC13, Shanghai, China, 2013.