

## SARAF EQUIPPED CAVITY TEST STAND (ECTS) AT CEA

O. Piquet, C. Boulch, R. Braud, P. Carbonnier, D Chirpaz, G. Ferrand, F. Gohier, F. Gouit, P. Guiho, T. Joannem, L. Maurice, G. Monnereau, A. Perolat, T. Plaisant, J. Plouin, P. Sahuquet, N. Solenne, IRFU, CEA, University Paris-Saclay, France

### Abstract

CEA is committed to delivering a Medium Energy Beam Transfer line and a Super Conducting Linac (SCL) [1] for SARAF accelerator in order to accelerate 5 mA beam of either protons from 1.3 MeV to 35 MeV or deuterons from 2.6 MeV to 40.1 MeV. The SCL consists in 4 cryomodules separated by warm section housing beam diagnostics. The two first identical cryomodules host respectively 6 and 7 half-wave resonator (HWR) low beta (0.091) cavities 176 MHz. In order to test the cavity with its tuner and coupler and validate some design consideration, the Equipped Cavity Test Stand (ECTS) has been designed and will be presented.

### INTRODUCTION

In addition to the vertical test for individual HWR qualification, the validation tests of the two different accelerating units (low and high beta HWR equipped with its tuner and power coupler), take place in a dedicated cryostat before the series production and the start-up of cryomodule assembly. These tests will provide benchmark data for the cavity behaviour (RF, mechanical, field probe, tuner calibration...) and will allow performing preliminary testing of some components of the SCL Linac: RF source, Local Control System (LCS) components and instrumentation.

### TEST-STAND AT SACLAY

For these tests, a dedicated test stand has been installed on Supratech Cryo/HF area at CEA-Saclay. It is made of a 176 MHz 10 kW solid state RF source, a dedicated and new cryostat, a biological protection and 2 cabinets for the local control system and instrumentation.

### ECTS Cryostat

This new cryostat (Fig. 1) is connected to Supratech Cryo/HF installation in order to benefit from the already existing cryogenic distribution. It mainly consists of:

- A vacuum vessel which supports the cavity / coupler assembly and insulates the cold parts from room temperature. The cavity is hung on the top lid of the vessel using four titanium alloy rods to limit the heat load on the cold parts.
- A phase separator is hung from the top plate through four vertical titanium alloy TA6V rods. This separator separates the gas and the liquid helium and keeps the cavity helium tank completely full of LHe. The separator has five cryogenic interfaces: with overpressure safety devices, the return GHe line, LHe filling transfer tube and the equipped cavity

- A thermal shield which limits the radiation heat flux on the cold parts. It is cooled with liquid nitrogen
- A magnetic shield made of mu-metal sheets fixed on the inner surface of the vacuum vessel to protect the cavity from the ambient magnetic field. The design of this shield allows a goal of a maximum of 2  $\mu$ T at the HWR surface by using 2 mm thick mu-metal sheets.

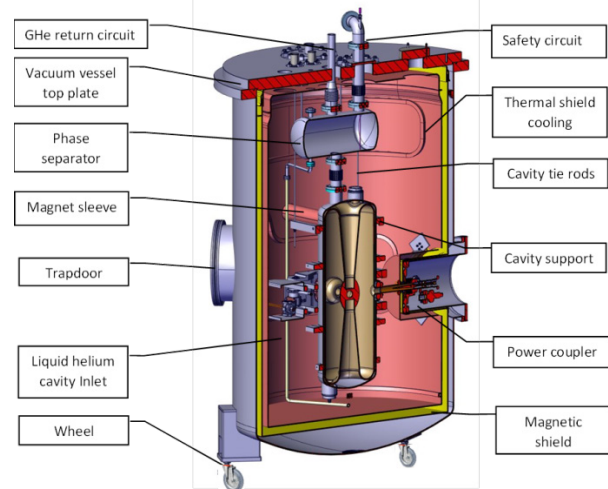

Figure 1: ECTS cryostat.

### LCS and Instrumentation

The supervision software to control the test bench (called LCS) is implemented using EPICS 3.15. Experiments measurements and controls are archived continuously using EPICS Archiver Appliance [2]. A single EPICS IOC controls the whole bench, managing acquisition, configuration and automatic conditioning. This IOC runs on a IOxOS IFC1210 VME card, and performs the high speed acquisitions ADC3111 mezzanine card (8 channels ADC 16-bit 250 Mps).

A Siemens 1500 PLC is used to run the logic of sensitive aspect such as the tuner motor, the vacuum and cryogenic processes. The PLC and the EPICS IOC communicate using Modbus (to send commands to the PLC) and S7PLC (to send status and measurements to the IOC) protocols.

This system allows acquisition of RF signals (forward and reflected powers and the cavity voltage) and monitoring of multipactor and spark-induced light emissions close to the coupler windows. These two last measurements are also compared to adjustable threshold and then used to drive a fast interlock input of the RF source in order to stop RF in less than 20  $\mu$ s.

The same instrumentation (hardware and software) will be used on the SCL.

## TEST WITH CRITICAL COUPLING

### Cavity-Tuner Assembly

The main objective of the critical coupling test was to qualify the cryostat with a known cavity to confirm cryogenic behaviour and magnetic shield efficiency.

The first prototype of low beta HWR cavity, which has been completed and qualified in vertical cryostat [3], is selected for this first test, in cryomodule-like conditions, in its nominal orientation and equipped with the cold tuning system (Fig. 2).

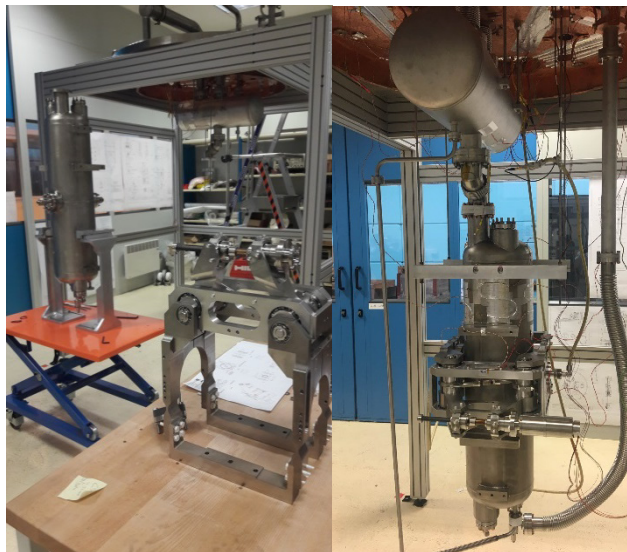

Figure 2: Cavity-tuner assembly.

### $Q_0/E_{acc}$ Measurement

This first test is used to compare the cavity performances in a cryomodule-like condition, in its nominal orientation and equipped with the cold tuning system, with the previous test done with naked cavity in vertical cryostat.

The cavity performance in the ECTS is above specifications at the operating temperature of 4.45 K ( $E_{acc} > 6.5$  MV/m with  $Q_0 > 7e8$ ) but slightly below results obtained with vertical test. The maximum accelerating field measured is now 7.8 MV/m and limited by maximum power acceptable by RF cables (Fig. 3).

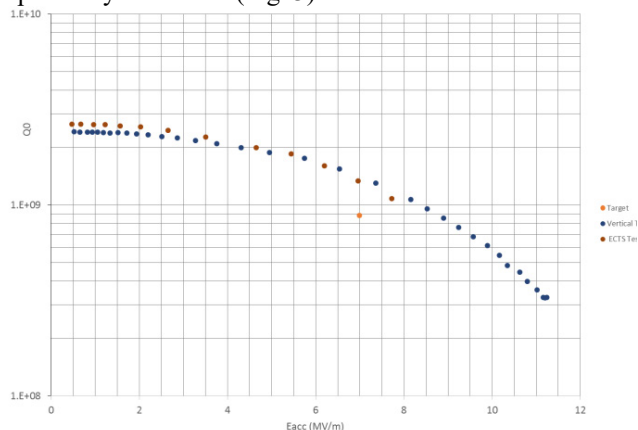

Figure 3: ECTS test compared to vertical test.

### Tuning System Measurement

The tuner force is applied on the beam port flanges, through titanium flexible levers. The resulting elastic deformation of the cavity lowers its RF frequency. The cold tuning system based on a Phytron cold motor and planetary gear box allows a tuning range which exceeds 100 kHz. It also uses a new and innovative resolver, intended for use with vacuum and cryogenic temperature, which improves the position regulation and the security.

The tuning accuracy is limited by the hysteresis of the tuner. This hysteresis for accurate tuning is mainly due to the slack between the parts (gears especially) of the motor. A 5 Hz peak-to-peak frequency pointing error results from repeated back and forth +/-20 Hz tuning motions.

### Cavity Performances into Magnetic Field

During the cavity tests, experiments have been carried out with a permanent magnet, in order to measure the effect of a static magnetic field on the cavity performance. To this purpose, the ECTS cryostat had been equipped with a special aluminum sleeve allowing the positioning of this permanent magnet close to the cavity (see fig 4).

The static magnetic field radiated on the closest part of the cavity varies from nearly 0.1 to 10 mT.

Two sets of experiments have been carried out:

- While the cavity was at 4.2 K and exposed to the maximal accelerating field, the magnet was moved close to the cavity. This had no effect on neither the accelerating field, nor the  $Q_0$ . This was expected, because the cavity is in the superconducting state, and its critical magnetic field is much in the order of 100 mT [4].
- The cavity was heat up to the normal state, cooled down to 4.2 K in presence of the magnet, and the  $Q_0/E_{acc}$  curve was measured. This experience was repeated for three positions of the magnet, and the  $Q_0$  dropped up to of a factor 10 for the closest magnet position. This demonstrates how the static field is trapped during cool down and thus generates an increase of the cavity surface resistance.

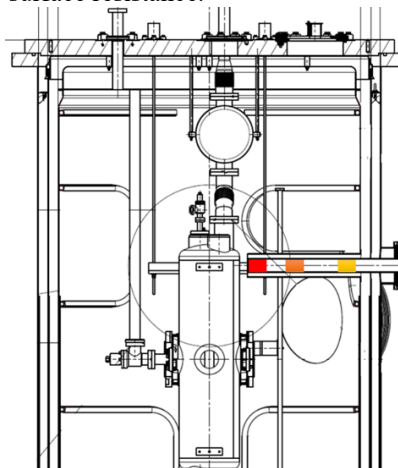

Figure 4: 3 positions of the magnet (red, orange and yellow) in the aluminum sleeve.

## TEST WITH POWER COUPLER

### Cavity-Coupler Assembly

After the first test with critical coupling, the cavity is returned to the clean room in order to be equipped with a power coupler (Fig. 5). This coupler has been conditioned at room temperature and up to 20 kW in November 2018 at CEA-Saclay [5]. This assembly has also permitted to validate the tooling and assembly sequence which will be used for the assembly of the whole cryomodule.

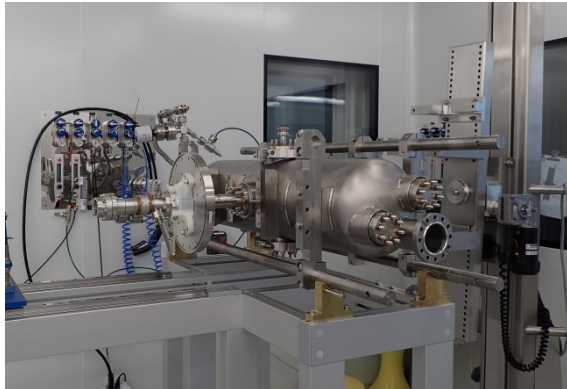

Figure 5: Coupler-cavity assembly.

The cavity with its power coupler and its cold tuning system is then assembled inside the ECTS cryostat.

### Cavity Test

The first step of this test is the warm conditioning of the coupler. An automatic procedure has been developed to control instrumentation system (mainly for the coupler protection) and to drive the 10 kW power amplifier. In the beginning, conditioning started with pulse duration of 50  $\mu$ s and a repetition frequency of 1 Hz with some hundreds of watts peak power level. The peak power level was then progressively increased up to the 10 kW. At this point the duty cycle was increased by acting on the pulse duration or the repetition rate. During this process, some outgassing with low multipacting was encountered in the regions between 200 W and 1 kW.

Then the cryostat is cooled down and the cold conditioning of the coupler is performed with the same procedure than for the warm conditioning.

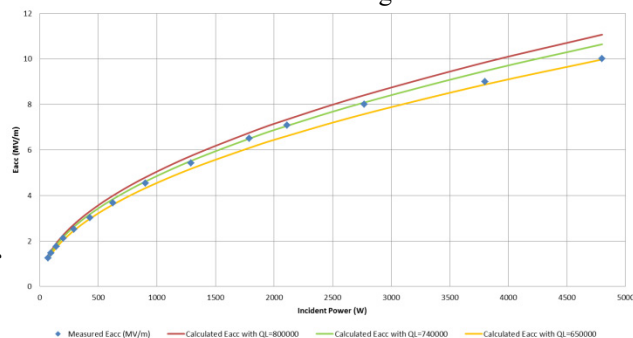

Figure 6:  $E_{acc}$  according RF power.

External quality factor has been measured with 2 methods: VNA at low power and fall time measurement at higher power. A value of 800000 has been measured.

The figure 6 shows the measured accelerating field versus the RF power and the comparison with calculations performed with measured and theoretical external Q-factor and RF power. These results show a good agreement between the 2 methods used to measure the performances of the cavity.

The RF losses in cavities can only be estimated by cryogenic measurements. Thermal losses are measured with RF power OFF then with RF power ON by measuring the return gas flow (Fig. 7).

Static cryogenic losses estimations are about 7 W for ECTS cryostat. Measured dynamic losses show that the assembly of the coupler with the cavity has not degraded the performances of the cavity.

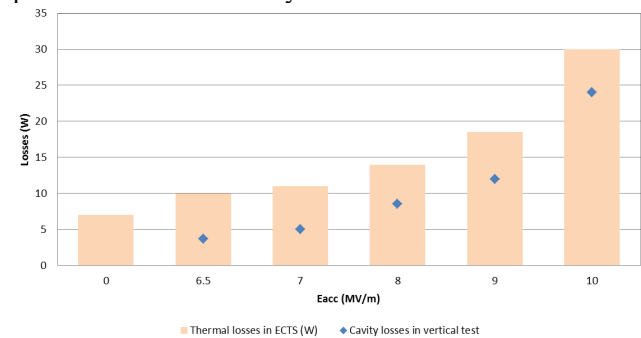

Figure 7: Cryogenic losses in ECTS cryostat compared to cavity losses measured in vertical test at 4.3 K

## CONCLUSION

The first ECTS test of the pre-serial low beta cavity was successful, validating a complete set of components: Half Wavelength Resonator (HWR) cavity equipped with He tank, tuning system and power coupler in the final cryomodule configuration. The nominal accelerating field of 6.5 MV/m is achieved with an injected power of 1.9 kW. This test has also permitted to validate the design of the tooling, the assembly operations of a cavity with its power coupler in clean room and a part of the LCS which will be used for the whole SRF cryomodule.

A second test is scheduled with the first prototype of High-beta cavity in July 2019.

## REFERENCES

- [1] N. Pichoff *et al.*, "The SARAF-LINAC Project Status", presented at the 10th Int. Particle Accelerator Conf. (IPAC'19), Melbourne, Australia, May 2019, paper TUPAK015, this conference.
- [2] F. Gougnaud *et al.*, "CEA IRFU EPICS Environment for the SARAF-Linac Project", in *Proc. ICALEPS'17*, Barcelona, Spain, October 2017.
- [3] G. Ferrand *et al.*, "Results of CEA Tests of SARAF Cavities Prototypes", presented at the 10th Int. Particle Accelerator Conf. (IPAC'19), Melbourne, Australia, May 2019, paper THPTS117, this conference.
- [4] H. Padamsee *et al.*, *RF Superconductivity for Accelerators*, 2nd Edition Wiley-VCH, 2007, p. 98.
- [5] G. Ferrand *et al.*, "Results of CEA Tests of SARAF Couplers Prototypes", presented at the 10th Int. Particle Accelerator Conf. (IPAC'19), Melbourne, Australia, May 2019, paper WEPTS118, this conference.

Content from this work may be used under the terms of the CC BY 3.0 licence (© 2019). Any distribution of this work must maintain attribution to the author(s), title of the work, publisher, and DOI