

INVESTIGATIONS ON ELECTRON BEAM IMPERFECTIONS AT PITZ.

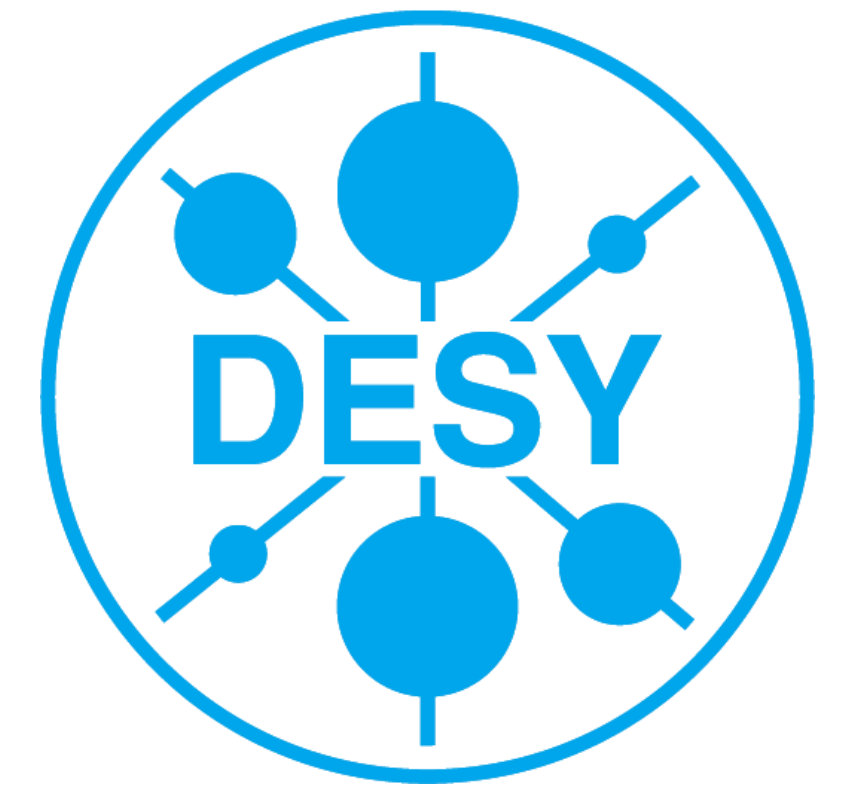

M. Krasilnikov, Q. Zhao, I. Isaev, P. Boonpornprasert, M. Gross, J. Good, H. Huck, D. Kalantaryan, O. Lishilin, G. Loisch, D. Melkumyan, A. Oppelt, G. Pathak, Y. Renier, T. Rublack, F. Stephan, G. Vashchenko, DESY, Zeuthen, Germany; C. Hernandez-Garcia, JLab, Newport News, Virginia, USA; G. Asova, INRNE, Sofia, Bulgaria

Abstract

Since more than a decade, the photo injector test facility at DESY, Zeuthen site (PITZ), has developed and optimized high brightness electron sources for modern Free Electrons Lasers like FLASH and the European XFEL. Despite a very high performance of the photo injector was experimentally demonstrated, several discrepancies between measurements and beam dynamics simulations have been revealed. Although the optimized measured values of the projected transverse emittance are close to those obtained from the beam dynamics simulations, the corresponding experimental machine parameters show certain systematic deviations from the simulated optimized setup. As a source for these deviations, electron beam imperfections were experimentally investigated. This includes studies on bunch charge production, electron beam imaging using the RF gun with its solenoid, and investigations on the transverse asymmetry of the electron beam generated in a rotationally symmetric gun cavity. Experimental studies were supplied with corresponding beam dynamics simulations. The paper reports on results of these studies.

Motivation – High Brightness Photo Injector Optimization

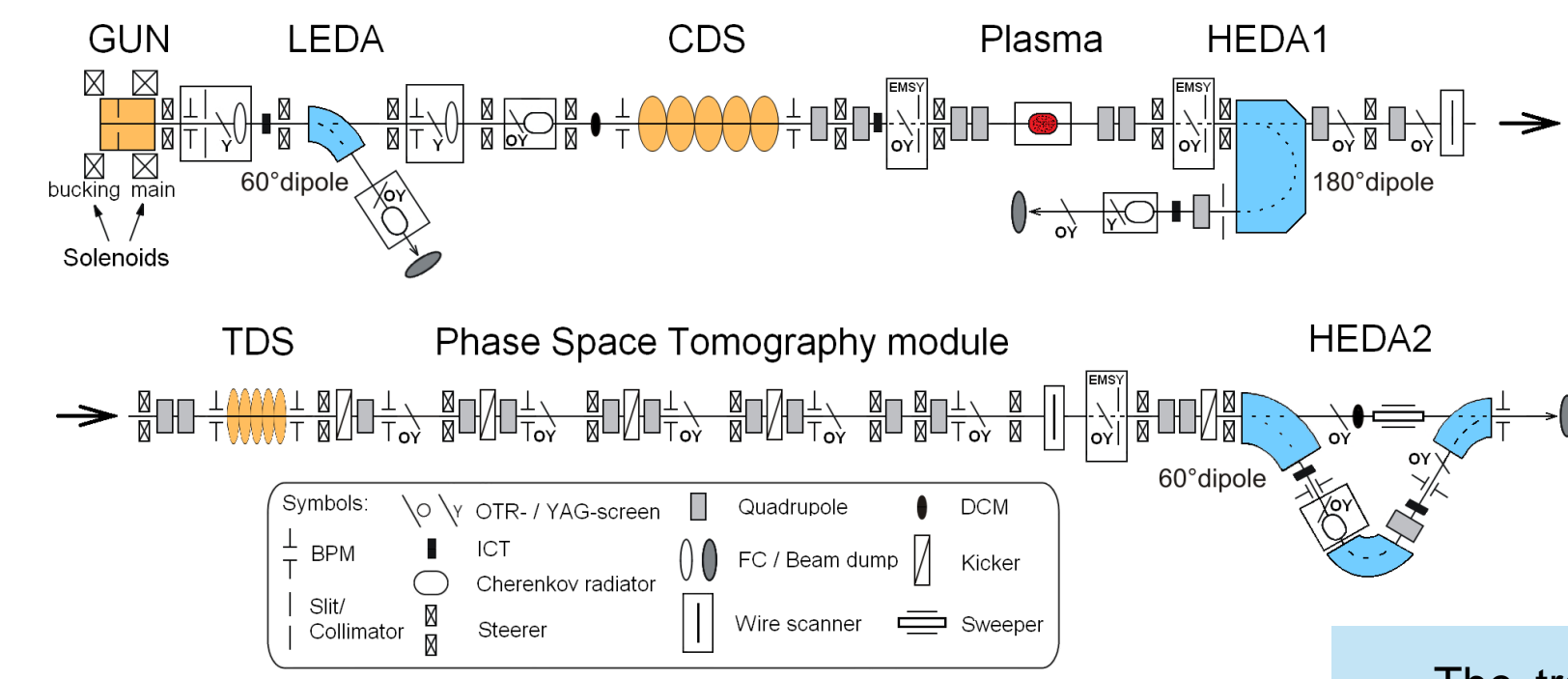

The transverse phase space of the electron beam from the 1/2-cell L-band RF-gun was measured in details while tuning numerous parameters, like gun gradient (Ecath) and phase, main solenoid current (Imain), cathode laser pulse temporal profile and transverse distribution. The 2015 measurement program was mainly dedicated to the emittance minimization for 500 pC electron bunches for Ecath=53 MV/m applying photocathode pulses with Gaussian temporal profile of ~11 ps FWHM [2].

A typical experimentally optimized 500pC electron beam

The transverse projected rms emittance of ~0.8 mm mrad (geometrical average of horizontal and vertical emittance) was obtained from the single slit scan technique [1].

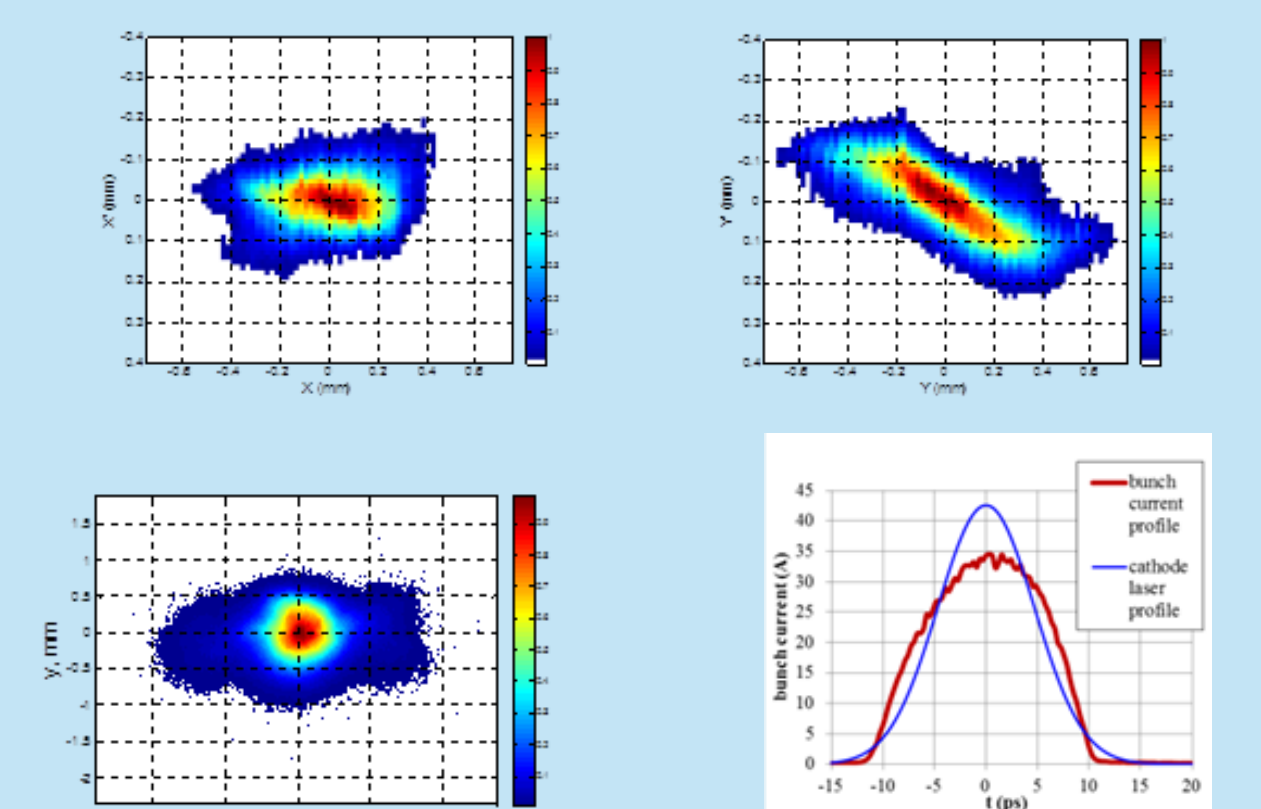

Electron beam transverse distribution at a YAG screen. Bunch current profile was measured using a transverse deflecting system [3].

The transverse rms spot size of the photocathode laser was optimized. The results are below together with simulated curves for different models of transverse laser distributions.

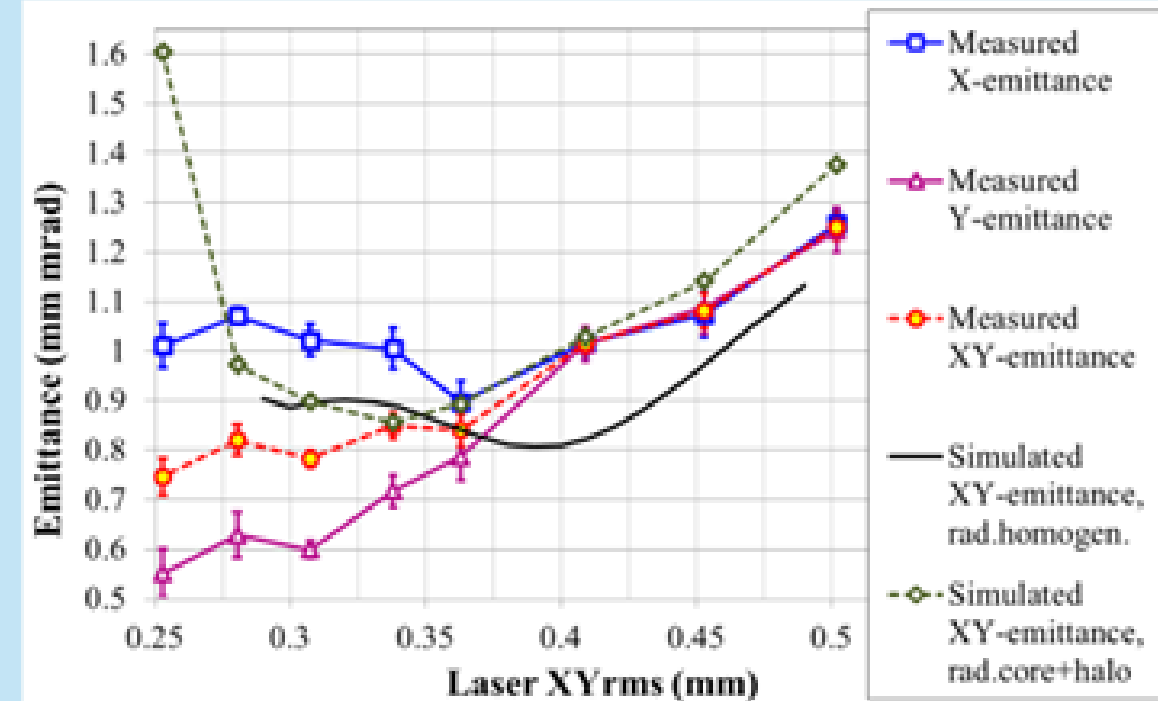

For each laser spot size the main solenoid current was optimized. Corresponding measured emittance curves are shown below together with rms sizes of the electron beam. Results of simulations are shown as well while applying the main solenoid current calibration obtained from the magnetic field measurements. A difference of ~5A in the optimum value for the emittance is clearly seen.

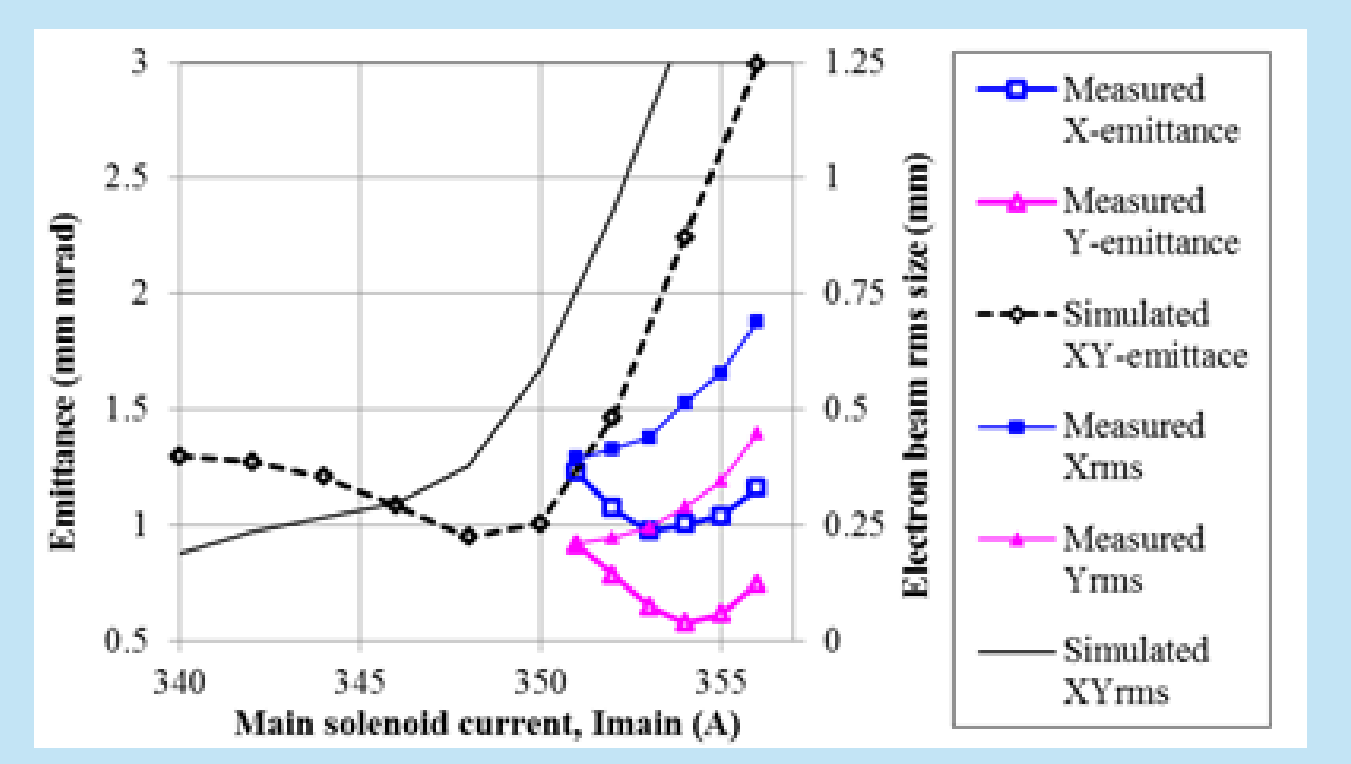

All these results show electron beam x-y asymmetries in terms of the rms sizes and emittances. The electron beam transverse distribution is strongly deviating from the rotationally symmetric shape expected from the beam dynamics simulations for the rotationally symmetric RF-gun cavity. Also some discrepancies between simulated and measured bunch charge were observed [1]. In order to investigate these imperfections dedicated studies were performed. This includes photoemission studies to understand the charge production, electron beam imaging for the cross-check of the main solenoid calibration and electron beam asymmetry studies to investigate the origin of the irregularities of the electron beam shape.

Photoemission

Experimental emittance optimization for fixed bunch charge yields a transverse spot size of the photocathode laser which corresponds to the case of a strong space charge effect during the photoemission. The working point for this case lies in the saturation region of the emission curve – dependence of the extracted charge on the photocathode laser pulse energy. These measurements were performed for a peak power in the gun of 6 MW (maximum beam momentum of 6.7 MeV/c) and using the laser with 0.2 mm rms spot size.

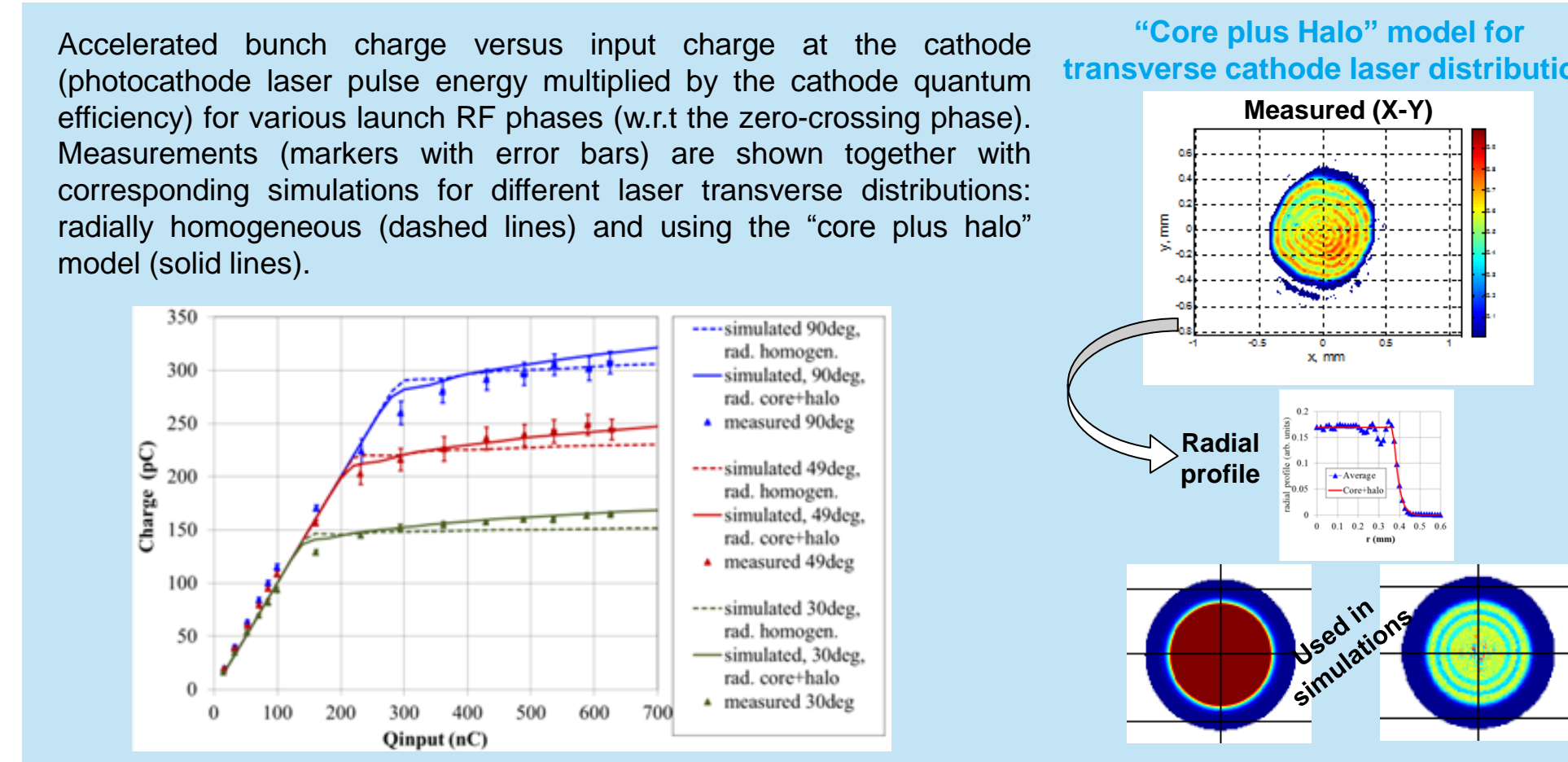

Beam dynamics simulations using ASTRA code [4] applying laser pulses with radially homogeneous distribution of rms size corresponding to the measured ones result in a stronger saturation of the emission curves. In order to explain this discrepancy a "core plus halo" model for the radial profile of the cathode laser was suggested. Analysis of the laser transverse distribution measured with a CCD camera located at a position optically equivalent to the cathode position reveals inhomogeneity of the radial profile. Besides the modulation of the core (ring structure in the high intensity region) the strongly decaying tails at the edge of the distribution can be responsible for additional increase of emission curves while the charge from the core is already saturated by the space charge effect (including image charge) at the cathode. Plugging such radially profiled laser pulses into ASTRA simulations (which implies the rotationally symmetric the space charge model for emission) resulted in significant improvements of measurement-simulation comparison. Despite better overall agreement between measurements and simulations, there still remains some discrepancy – the simulated charge is higher in the transition between linear and saturated range of the curves. Nevertheless this model yields also better agreement for the emittance simulations.

Electron beam asymmetry studies: „Larmor angle experiment“

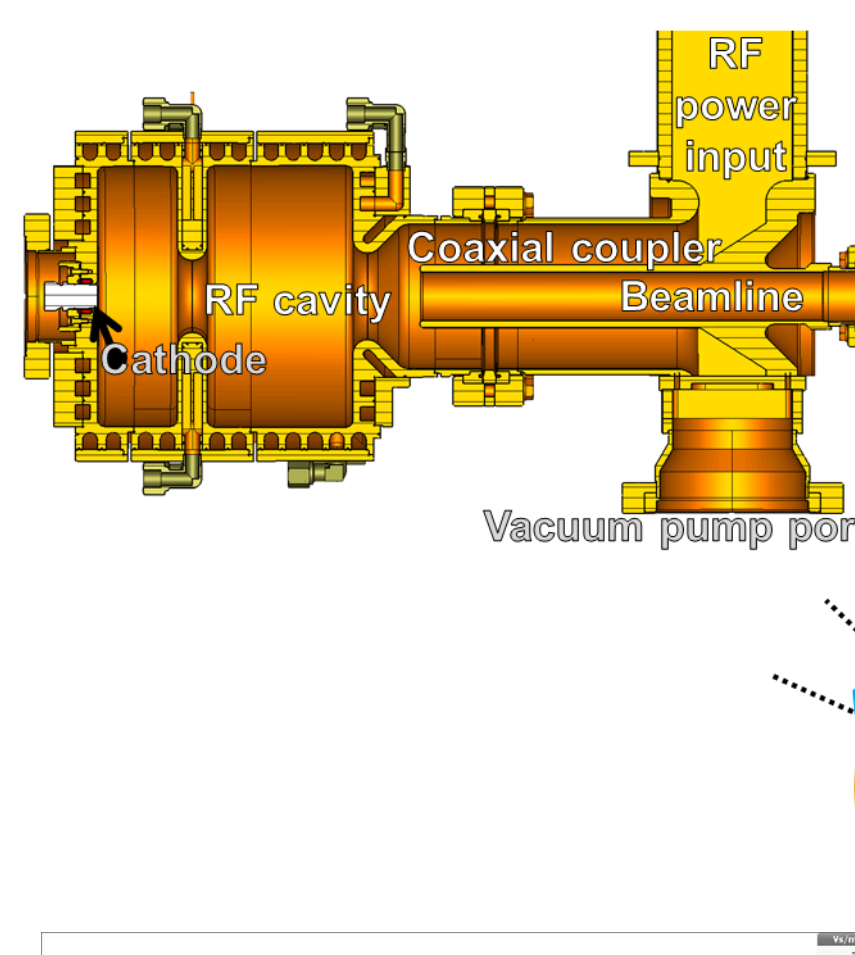

In order to investigate the origin of the electron beam XY-asymmetry several dedicated experimental studies have been done. One of them is the so-called "Larmor angle experiment". This implies measurements of the beam transverse distributions at one of the YAG screens for both polarities of the main solenoid. The machine setup close to the optimized emittance one was used for these studies: maximum beam momentum of 6.1 MeV/c (5 MW peak power in the gun), cathode laser with transverse rms size of ~0.3 mm at the cathode (~1.2 m diameter), bunch charge of 500 pC. The bucking solenoid and the CDS booster were switched off for these measurements.

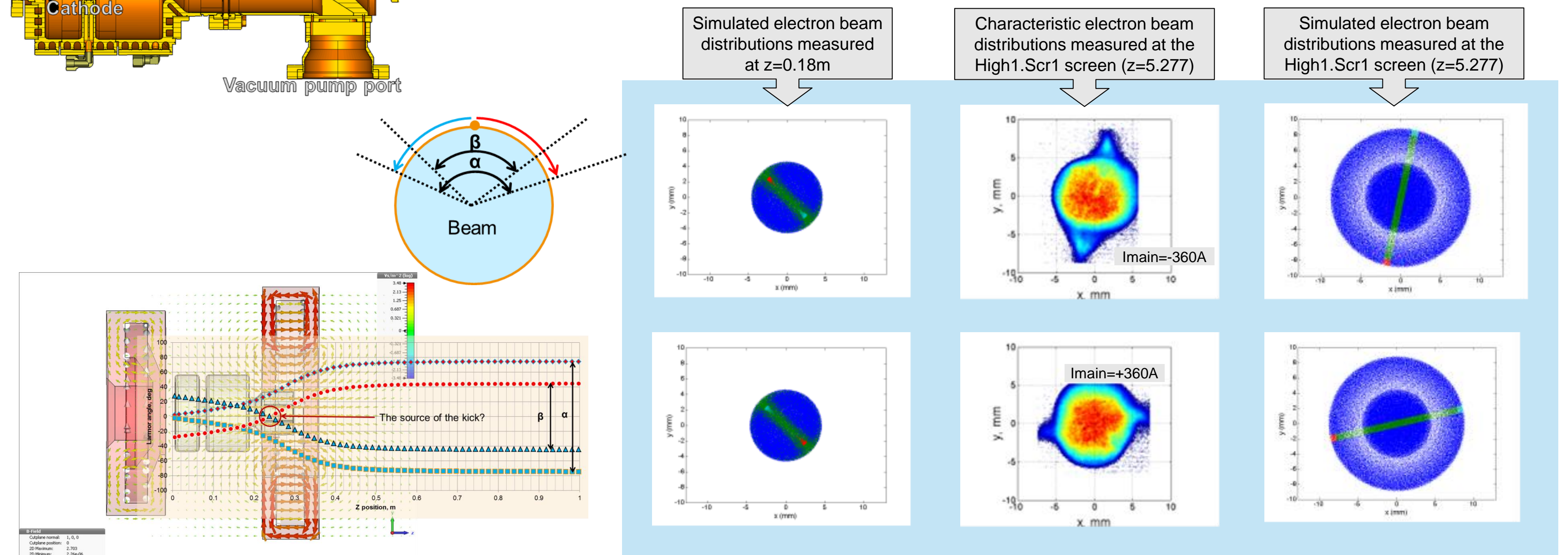

The orientation of tails in transverse distributions can be used to determine the z-location of the kick onto the transverse phase space. Corresponding ASTRA simulations were performed for a rotationally symmetric beam by using the "core plus halo" model (see the section above) and applying the main solenoid calibration (1). Particles with an angle orientation corresponding to the tails marked with green, red and cyan color were tracked back towards the cathode until their overall angular orientations coincide. According to this approach z=0.18 m was found as an origin of the kick onto the transverse phase space causing corresponding features observed at z=5.277 m. This is the location of the transition from the coaxial power coupler to the gun cavity as well as the location of one edge of the main solenoid yoke. The kick orientation is estimated to be about -45°. More detailed analysis of the kick structure reveals the presence of quadrupole and skew quadrupole components which should be applied in order to simulate the measured features. Further investigations to quantify the kick, parametrize it w.r.t. the RF gun and solenoid settings are ongoing with the goal to develop a compensation device.

Electron Beam Imaging

Electron beam imaging is enabled by reducing the space charge effect (low charge density) and assuming a laser length short enough to reduce achromatic effects. Under this principle, experimental and simulation studies on beam dynamics of RF and solenoid fields of the PITZ gun without space charge were performed, by which the calibration of the main solenoid can be cross-checked together with RF field properties. Magnetic field measurements with a Hall probe yielded the main solenoid calibration formula:

$$B_z [T] = 5.889 \times 10^{-4} \times I_{main} [A] + 7.102 \times 10^{-5} \quad (1)$$

For the experiment, a grid is inserted in the laser beam line at the beam shaping aperture position. The laser beam passes through the grid and is shaped and being imaged onto the photocathode. The electron beam with this pattern is accelerated by the gun RF field and is focused by the solenoid field. The transverse distribution of transported electrons is monitored at three screens downstream the gun: Low.Scr1 (at z=0.803 m), Low.Scr2 (at z=1.379 m) and Low.Scr3 (at z=1.708 m).

The grid electron beam images from experiment and simulation with ASTRA at three screens with different solenoid currents. The magnification factor and the rotation angle of the grid from experiment were investigated with solenoid scan and compared with simulations. For 5 MW peak power in the gun the magnification factor and the rotation angle show good agreement between experiment and simulation, but there are some discrepancies between experiment and simulation for other screens and different gun power levels. More experiments and analysis for different gun powers and full solenoid current scans are ongoing.

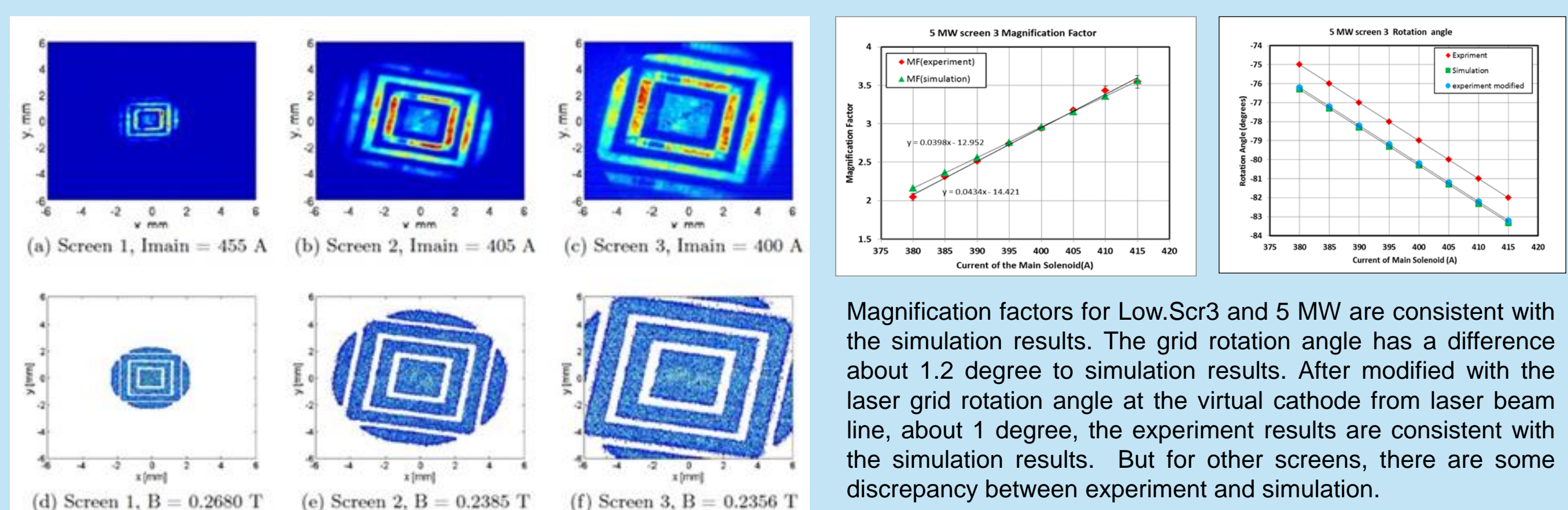

Magnification factors for Low.Scr3 and 5 MW are consistent with the simulation results. The grid rotation angle has a difference about 1.2 degree to simulation results. After modified with the laser grid rotation angle at the virtual cathode from laser beam line, about 1 degree, the experiment results are consistent with the simulation results. But for other screens, there are some discrepancy between experiment and simulation.

Conclusions

Experimental studies and simulations have been performed at PITZ in order to explain the discrepancy between measured and simulated properties of electron beams. The "core plus halo model" in the modelling of the transverse cathode laser pulse distribution yields better agreement for the bunch charge production. A beam based check of the main solenoid calibration was done using the electron beam imaging technique. Electron beam XY-asymmetry investigations revealed a possible location of a kick onto the transverse phase space at z~0.2 m from the cathode. Detailed studies to quantify the kick are ongoing.

References

- [1] M. Krasilnikov et al., "Experimentally minimized beam emittance from an L-band photoinjector", Phys. Rev. ST Accel. Beams 15, 100701 (2012).
- [2] G. Vashchenko et al., "Emittance measurements of the electron beam at PITZ for the commissioning phase of the European XFEL", Proc. FEL'15, pp. 285-288, Deajeon, Ko-rea (2015).
- [3] H. Huck et al., "First Results of Commissioning of the PITZ Transverse Deflecting Structure", Proc. FEL'15, pp. 110-114, Deajeon, Korea (2015).
- [4] "A Space-charge TRacking Algorithm, ASTRA", http://www.desy.de/~mpylo/ASTRA