

AN FPGA-BASED BUNCH-BY-BUNCH TUNE MEASUREMENT SYSTEM FOR THE APS STORAGE RING*

C.-Y. Yao[#], Y.-C. Chae

Advanced Photon Source, Argonne National Laboratory, Argonne, IL 60439, USA

W.E. Norum

Lawrence Berkeley Laboratory, Berkeley, CA 94720, USA

Abstract

A bunch-by-bunch tune measurement system was developed for beam diagnostics and machine studies of Advanced Photon Source (APS) storage ring. It can be applied to such machine physics studies as characterization of transverse impedance, observation and identification of coupled-mode instabilities, and electron cloud effects. The system has a single-bunch and a multibunch operation mode. In single bunch mode tunes are processed with FFT. In multibunch mode the system excites a set of driven bunches with a frequency sweep signal, samples a set of monitored bunches, and extracts amplitude and phase information from sampled data using digital demodulation method. We report its hardware and software design, performance, and recent experimental results on the APS storage ring beam.

SYSTEM DESCRIPTION

The bunch-by-bunch tune measurement system was originally developed as a diagnostics tool for a transverse feedback system at the APS [1]. It now serves as an alternative of the original storage ring tune measurement system that uses spectrum analyzers.

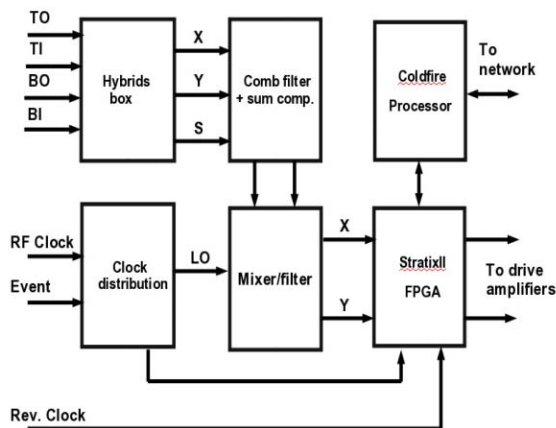

Figure 1: Block diagram of the tune measurement system.

Figure 1 shows a diagram of the system. The front-end circuit consists of a hybrid input box, a 3-tap comb filter

and sum compensation circuit, and a down converter mixer. The LO input of the mixer is a 352 MHz clock signal directly derived from main rf source. The front-end and pickup stripline are shared by the tune measurement system and a transverse feedback system [2]. The tune measurement module consists of a StratixII DSP development board [3] for data conversion and processing, a ColdFire uCDIMM card as EPICS IOC, and a small daughter card for receiving timing synchronization signals from the APS even system. Other than this small daughter card, all components are commercial, off-the-shelf.

Two 12-bit 125 MHz ADCs on the FPGA board are used for beam position acquisition, one for each transverse plane. Two 14-bit 175 MHz DACs are used for generating chirp signals for both planes. Two trigger output channels provide synchronization with external excitation sources.

FIRMWARE PROCESSES

Figure 2 shows a block diagram of the tune measurement firmware. The ADC block acquires input beam signals at a rate of 117 MHz, or 1/3 of the storage ring rf frequency.

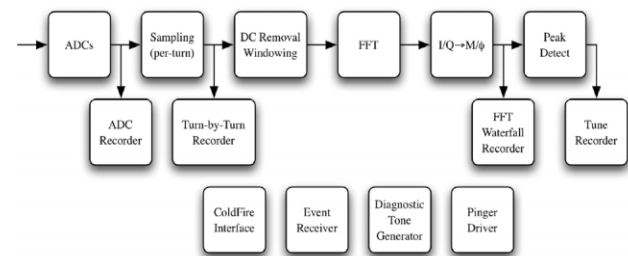

Figure 2: Block diagram of the tune measurement firmware.

The system has two operations modes: a single-bunch mode that provides tune measurement of any single bunch of the storage ring, and a multibunch mode that chirps a train of selected driven bunches and acquires tune data on another train of monitored bunches.

*Work supported by U.S. Department of Energy, Office of Science, Office of Basic Energy Sciences, under contract No. DE-AC02-06-CH11357

[#]cyao@aps.anl.gov

In single-bunch mode operation fast Fourier transform (FFT) is performed on records of 2048 turn-by-turn samples. The FFT and rectangular-to-polar conversion are accomplished in less than 20 μ sec. The FFT results are presented as an EPICS [4] waveform record. A waveform record contains magnitude components up to 128 FFT measurements of 1024 frequency points each. With typical pinging excitation patterns, this corresponds to an acquisition time of about 1 second.

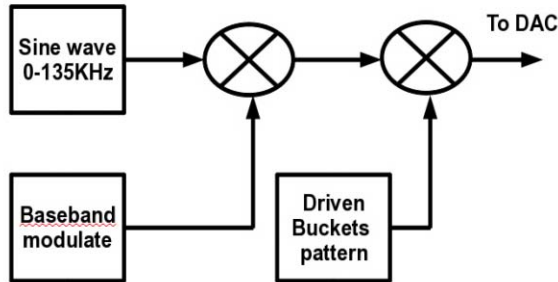

Figure 3: Block diagram of the chirping signal generator program.

A turn-by-turn waveform is available for recording raw ADC samples of beam position of up to 262144 turns. It is mainly used for offline tune processing, system diagnostics, and capturing of transient beam motions.

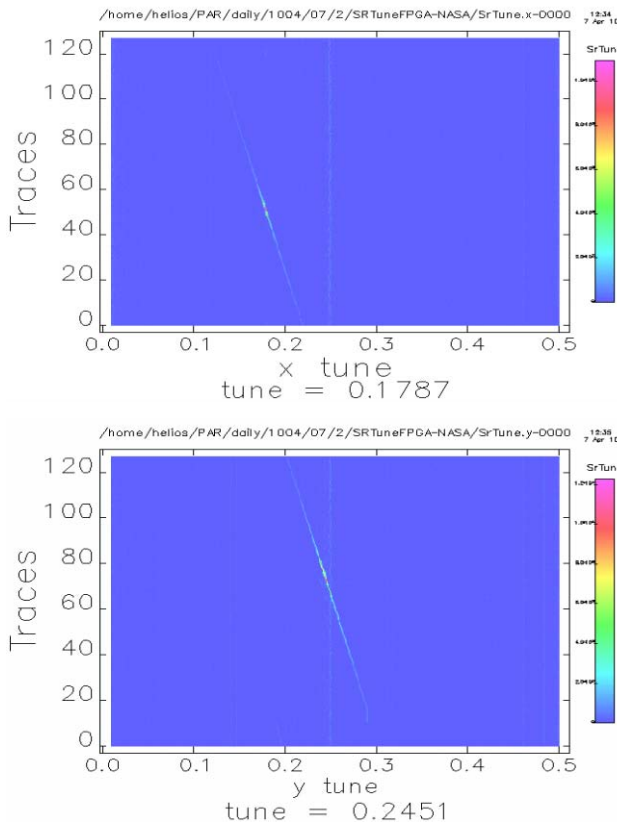

Figure 4: Contour plots of APS storage ring tune measurement results. The vertical axis is the trace number. Each trace represents about 8 ms. The vertical line in the middle of the plot is an unidentified noise sideband.

Instrumentation

TUNE MEASUREMENT

The APS storage ring normally operates with high chromaticity in both planes and strong sextupole currents. The beam has a large tune spread. Centroid beam motion dissolves within 100 turns of a perturbation. This is mainly due to the de-coherence effect of a large tune spread. In order to achieve good tune measurement results, continuous chirping is necessary.

Figure 3 shows a block diagram of the chirping generator. A sine waveform tune frequency signal is first modulated with a DC (baseband) or a ± 1 pulse (modulated). It is then modulated with a driven-bucket pattern pulse train. The modulated mode is necessary to avoid an AC coupling effect of the DAC output and amplifiers.

In single-bunch mode, the beam is excited by an external source -- a HP6396A network analyzer. Sampled data are FFT processed with a tune resolution of 0.001. The FFT result can be shown both in an amplitude versus tune plot or in a spectrograph. In the latter case, the time variation of spectrum can be reviewed easily. Figure 4 shows spectrographs of both the x and y tunes.

In the multibunch mode digital demodulation method is used to derive tune peaks. A chirping signal, which consists of a sequence of frequency points with each point lasting 2048 revolution periods, is generated by the FPGA and sent to the drive stripline to excite the beam. The digital waveform data of the same chirping signal is digitally demodulated with the beam position signal to produce amplitude and phase for each frequency point. Only amplitude data are further processed, and one data point is generated for each bunch and each frequency point. The driven buckets and monitored buckets are selectable.

A graphic interface application was developed to simplify operation of the system.

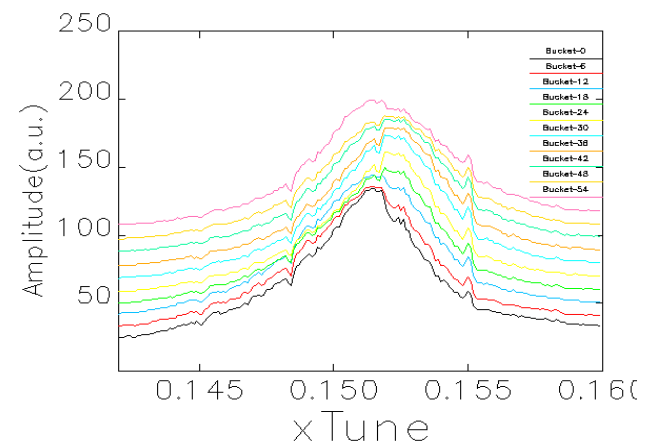

Figure 5: A plot of multibunch horizontal tune results with 6-bucket spacing showing a maximum tune shift of 0.001 in this case.

APPLICATION TO BEAM STUDIES

The multibunch mode is used to investigate possible ion trapping or electron cloud effects in the APS storage ring. In this case, a train of buckets is filled, and tunes of each bucket were measured. We have observed a horizontal tune shift of 0.001 to 0.004 between the leading and trailing bunches. Further study is needed to fully characterize the phenomenon. Figure 5 shows a plot of horizontal tune versus bucket number for a 6-bucket spacing bunch train.

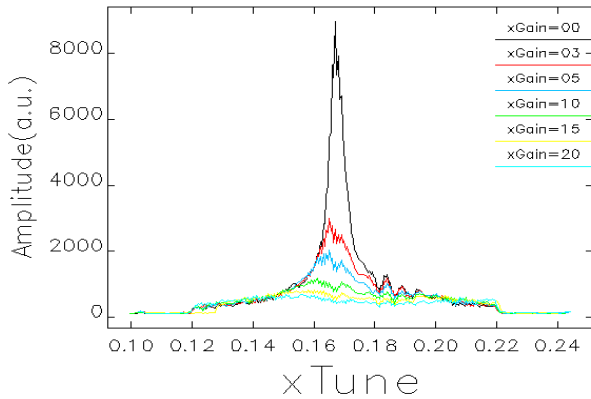

Figure 6: Horizontal feedback gain scan result.

The system is used to measure the damping time of the feedback system. Beam is excited by the tune measurement drive signal, and we scanned the gain of the transverse feedback system. The amplitude response of a damped oscillation excited at resonance frequency is proportional to damping time τ . A relative damping time can be estimated from the gain scan. Figure 6 shows a result of a horizontal gain scan.

Using the tune measurement system we successfully identified a 40 kHz noise that is generated by the switching power supplies of the vertical and horizontal faster correctors, which has an effect on the storage beam motion and impacts the function of feedback system. The noise was eliminated by installing additional filters on all fast corrector supplies.

The system can also be used to record injection transients. Figure 7 shows recorded horizontal beam motions. In the first plot, due to the strong amplitude dependency of tunes, the centroid beam motion of stored beam de-coheres within only 30 turns. In the second plot beams with different chromaticity are kicked with a 1 kV kicker pulse. Damping time increases as chromaticity decreases.

FUTURE UPGRADE PLAN

The current version of the hardware limits sample rate to 117 MHz, or sampling every third storage bucket. We plan to upgrade the front-end electronics and the ADCs to a sample rate of 352 MHz so it can measure arbitrary fill patterns, which is important for many study subjects.

We also plan to add a mode detection feature so the system can be used to monitor couple-bunch mode instabilities for equally-spaced fill patterns.

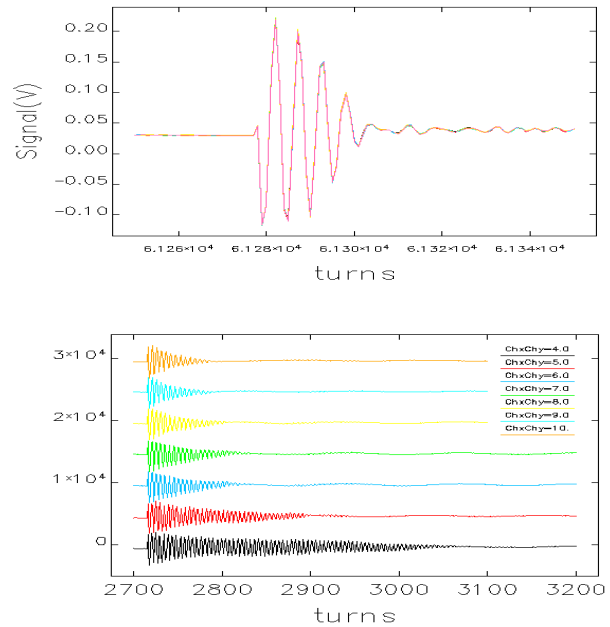

Figure 7: Top: storage ring injection transient. Bottom: horizontal beam motion after a kicker pulse with 1 kV amplitude with different chromaticity. Legend are chromaticity in both x and y planes.

CONCLUSIONS

We developed a bunch-by-bunch tune measurement system. It is a powerful tool for investigating beam instabilities, diagnosing feedback system, and for studying ion trapping, ion cloud effects, and injection transient.

ACKNOWLEDGMENTS

The authors acknowledge Hairong Shang, Louis Emery, Frank Lenkszus, Bob Laird, Chuck Gold, Randall Zabel and Pat Dombrowski for their contribution, discussions, and assistance for this work. We also thank APS operations staff for their support.

REFERENCES

- [1] C.Y. Yao et al., “An FPGA-based Tune Measurement System for the APS Booster Synchrotron,” Proc of BIW08.
- [2] C.Y. Yao et al., “An FPGA-based Bunch-to-bunch Feedback System at the Advanced Photon Source,” proc of PAC07.
- [3] “Stratix II EP2S60 DSP Development Board Data Sheet,” <http://www.altera.com/products/devkits/altera/kit-dsp-2S60.html#documentation>.
- [4] “Experimental Physics and Industrial Control System,” <http://www.aps.anl.gov/epics/index.php>