

EXPERIMENTAL SETUP OF APODIZATION TECHNIQUES FOR BEAM DIAGNOSTICS PERFORMED AT ELBE

B. Freeman, J. Gubeli, and K. Jordan, Jefferson Lab, Newport News, VA, USA
P. Evtushenko, HZDR, Dresden, Germany

Abstract

The ELBE (Electron Linac for beams with high Brilliance and low Emittance) facility in Dresden, Germany is a multi-purpose user facility, which is also used for accelerator R&D purposes. The beam line was setup for transverse beam profile measurements, where the imaging system includes a series of three apodizers and five circular apertures. Both of which could be changed remotely during beam operation, through automated LabVIEW routines. The bunch structure and charge were varied to collect a series of images that were acquired automatically, and then stored for later analysis. Over 12,000 images were captured and then analyzed using software written at Jefferson Lab that runs ImageJ as its main image processing library.

INTRODUCTION

Large Dynamic Range (LDR) diagnostics are becoming increasingly important for high current and high beam power accelerators. Machines where a transverse and longitudinal match must be computed to control the beam optics, a lower average beam current is typically used. When setup is believed to be complete the beam current and duty cycle are usually increased. It has been the experience at the JLab machines, both CEBAF and the FEL [1], in its operation, that the best of setups are just not good enough initially to transport the beam at the requested beam power, without beam losses. The setup, either in the transverse or longitudinal plane must be revisited to sustain the beam power requested by the users. The reason for this, is the inability of the available diagnostics to detect beam tails and beam halo ahead of the machine protection system [1]. The operational impact of this can be significant and has caused some to investigate ways of improving the ability to setup, and to investigate diagnostics that could see the tails and halo during setup.

The smallest point that can be resolved in an optical system is defined by its point spread function (PSF). It is a function of the angular acceptance of the aperture. In the Fourier optics, it is the Fourier transform of the pupil function. When light is collected through the aperture, diffraction effects limit the smallest resolvable spot. To improve the dynamic range of the system, which is defined by (*Peak/Noise*), apodizers have been suggested to decrease diffraction in the image plane and drive the noise level down even farther. Apodizers have been used in astronomy, when observing stars which are tiny point sources of light. An apodizer is a Gaussian spatial filter, which limits the amount of light that can enter the image plane by decreasing the transmission of light radial out from the center of the filter. The transmission

profile of the filter is defined by

$$T(r, \sigma) = T_0 e^{-\left(\frac{r}{\sigma\sqrt{2}}\right)^2} \quad (1)$$

where $T_0 = 97\% \pm 1\%$ [2].

Three apodizers were ordered, all were made on a fused silica substrate. Two of the apodizers were made using a half tone dot method. Which means they were constructed with 10 μm pixels that have an increasing density radially by the relation Equation 1. The pixel density changes the amount of light that is transmitted through the filter. The two half tone gaussian profiles were made such that $\sigma = 6 \text{ mm} \pm 0.3 \text{ mm}$, and $\sigma = 12 \text{ mm} \pm 0.3 \text{ mm}$. The third apodizer was constructed using a reflective coating with increasing density radially outward from $r = 0$ at the center of the filter, with $\sigma = 12 \text{ mm} \pm 0.3 \text{ mm}$ [2].

EXPERIMENTAL SETUP

The ELBE (Electron Linac for beams with high Brilliance and low Emittance) facility in Dresden, Germany was chosen because of the many configurations possible. The facility is a multipurpose user facility which can also be used for R&D applications. The electron beam at ELBE was setup to allow for several different bunch charges, at different micro-pulse frequencies. The overall purpose of the experiment was to put the Gaussian apodizers to the test, with a large range of various light intensities. The experimental setup was set up to automate the process of varying the apodizers, a series of 5 circular apertures, exposure times, and camera gains.

Mechanical Setup

A Large Dynamic Range Diagnostic Station (LDRDS) was used in this experiment to profile the electron beam. The LDRDS consists of a six inch cross with two beam intercepting devices and two six-inch conflat flange viewports. One device is a stepper motor driven linear shaft with a two wire fork (wire scanner). The fork is orientated at 45 degrees to the beam along two axes with the wires set horizontally and vertically along the beamline. This fork angle is set to allow any optical transition radiation from the wires, as they pass through the electron beam, to be directed out one of the viewports. This fork is electrically isolated from the chamber and connected to an SMA feedthrough. The lead-screw, gear box and stepper motor combination has a linear resolution of 127 nm ($\frac{1}{2}$ step) and a maximum linear speed of 1.27 mm/second.

The second device is a two-stage pneumatically driven linear stage. The center shaft is rigidly attached to a slide on two linear ball bushing bearings to produce a very repeatable insertion position. A ball bearing is used as a coupling

between the pneumatic shaft and the stage to eliminate off-axis stage force. The ball bearing is kept in place by two constant force springs. In the experiment setup, the end of the center shaft supports a viewer flag as well as a beam shield to reduce beamline impedance. The viewer flag consists of a polished 50.8 mm diameter, 0.1 mm thick YAG:Ce crystal with an AR coating on both sides centered at 550 nm. The YAG:Ce is held normal to the beam with a polished aluminum mirror behind it at 45 degrees to the beam. This arrangement allows the back of the crystal to be imaged through the second viewport. The LDRDS is installed in the radiation physics user beamline at ELBE, Figure 1.

Optical Setup

An object telecentric optical design was used to image the YAG:Ce crystal. Three achromatic lenses were used in the design to create a combined magnification of $-1/3$. The sensor used for this experiment is a JAI's Fusion Series AD-081GE [3]

it is a 2-CCD High Dynamic Range progressive scan camera. This GigE Vision interface camera features two independently controlled CCDs that can be combined to double the dynamic range over a standard CCD. The AD-081GE has a 1024×768 $4.65 \mu\text{m}$ pixel array which allowed us to image a $10.6 \text{ mm} \times 14.2 \text{ mm}$ object.

Two mirrors were used in the optical design to both jog around an existing obstruction and to move the camera off axis to the secondary electron shower generated at the viewer flag. An Edmund Optics motorized five position filter wheel was placed at the field stop location of the first lens. Loaded in this filter wheel were five circular apertures with diameters set to a half angle field of view of one to five degrees in 1 degree steps. A rotary motorized stage that supported three apodizers was placed between the second and third lens. A 3D CAD model of the setup can be seen in Figure 2 and physical devices as seen in Figure 3.

AUTOMATION

LabVIEW

LabVIEW was chosen as the controls and interface platform for this experiment. One nice feature of LabVIEW, along with its ease of interfacing equipment through various methods and in creating Graphical User Interfaces, is that it has a Vision Development Module and a Vision Acquisition Software package. These packages made interfacing the GigE camera nearly trivial. Three standalone LabVIEW applications were written to control the filter wheel, the rotary stage (which allowed for apodizer change out), and the GigE camera.

The application for this experiment contained a state machine that calls on these three hardware applications and ensures the completion of tasks in the proper order. The application was developed to capture and save images from one or both sensors after verifying that the optic line and camera sensors were set correctly. The variables for each image save were the selection of an aperture, an apodizer, a

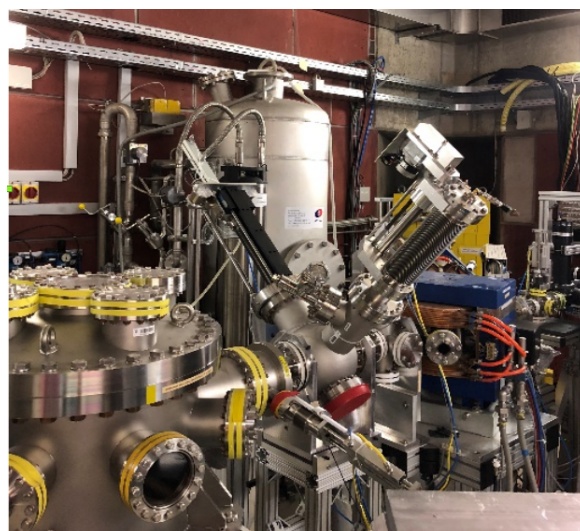

Figure 1: Large Dynamic Range Diagnostic Station (LDRDS) as positioned at ELBE.

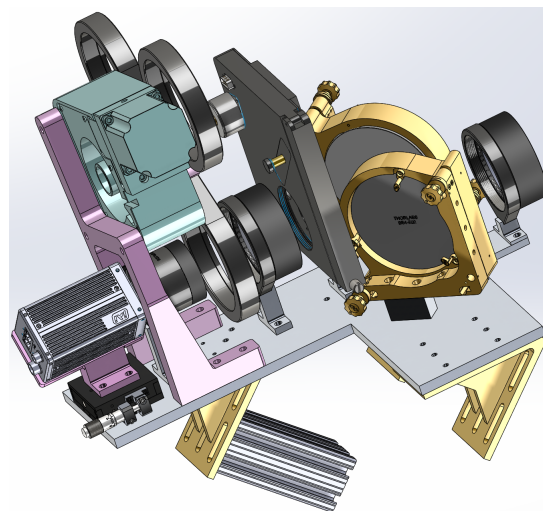

Figure 2: CAD drawing of the optical setup.

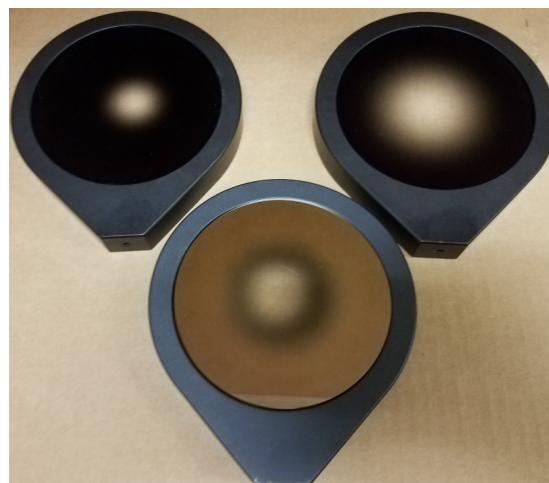

Figure 3: Apodizers installed in mechanical holders.

sensor gain setting and a sensor exposure time. To ensure that we didn't waste valuable beam time at ELBE, the application was developed to execute quickly and to be very flexible. The application would read a four column recipe from a text file and continue to capture and save images until each line was executed. To allow for the quickest run time, the recipe was written as a series of nested loops with the outer loop being the slowest to complete.

For this experiment, these loops were of three exposure times (inner loop), twelve gain settings, five apertures and three apodizers (outer loop). For each electron beam setup, the run script would capture 540 images in less than six minutes.

Image Analysis

Over 12,000 images were collected from the automated Lab View routines. They were saved to disk and taken back to Jefferson Lab for image analysis. Image analysis was done using a series of perl scripts and software that has been in development for sometime at Jefferson Lab. The software is a pure Java based library, which leans heavily on the ImageJ application. ImageJ is an open source application that was developed by a special for the National Institutes of Health (NIH) for medical imaging analysis. It has a wide variety of features, including the processing of many popular image formats in 8, 16, 24, or 32 bit image formats [4].

The images analyzed were in the format of 16 bit png files. First, the images were organized by aperture, gain, electron beam charge, and exposure time. The software was setup up to process the horizontal and vertical profiles, and then fit a Gaussian function to each of the profiles. After the profiles are written to a file, another script generates a plot for each set of apodizers and then the signal to noise ratio (SNR) in decibels (dB) was computed for each of the image profiles. A set is defined as, all three apodizers for the same camera gain, beam parameters, and each of the apertures. If one of the profiles had $R^2 \leq 0.90$, where R^2 is the goodness of fit, the set was rejected. Then the set of apodizers were compared to one another. The over all goal of this calculation is to be able to see which apodizer statistically does the best at reducing the background in the image while allowing the peak signal to be transmitted through. In theory if the transmission profile for the $\sigma = 6$ mm apodizer is half as much as the $\sigma = 12$ mm.

RESULTS

We still have a considerable amount of images to process to better characterize the apodizers and especially in terms of the images size at the apodizer. We have processed the SNR of 12,417 images and have compare the results of the three apodizers. The $\sigma = 12$ mm reflective apodizer had by far the best SNR for all the image sets. In the horizontal profiles it had the best SNR by 96.5% with 8.6% of the sets rejected for one of the profiles having a poor Gaussian fit. Similarly in the vertical profiles it had the better SNR by 94.4% with 8.8% sets rejected. Some processing was done

in comparing the effects of the aperture sizes and therefore the image size on the apodizer. As expected, the center line pixel intensity profiles of each of the apodizers were near identical with the small angular acceptance aperture. The SNR in these sets of images were within fractions of dB of each other. As the angular acceptance increased, the more the SNR deviated.

Another interesting, but perhaps not surprising observation was that for small angles of angular acceptance of the apertures, the profiles almost were on top of each other. The SNR of the three in these sets of images were within fractions of dB. The $\sigma = 12$ mm apodizer still won in most cases, although a marginal win. As more light is collected through the aperture, the more the diffraction will affect the image quality. As the angular acceptance increased, the more the SNR deviated.

Figures 4 and 5 represents an example of the plots generated. All three profiles for the three apodizers are shown on the same plot for a particular data set. Figure 4(a) shows the all three of the profiles for the first aperture, which has 1 degree of angular acceptance. Figure 4(b) shows the images used to generate the plot. The images are very close in profile and appearance. Figure 5 shows the same data set, but the 5th aperture was used, which has 5 degrees of angular acceptance. One can easily see that there are more variations in the images in Figure 5(b) than the images in Figure 4(b).

IMPROVEMENTS

Some improvements to the system and data collection could be made to improve the process, and ability to further analyze the images. For one, an image should have been captured for each set with no apodizer inserted. This would have provided the ability to compare the affect of having an apodizer or not. Based on the data, it may not matter for small angles of light acceptance. For larger angles of light acceptance it may have mattered greatly. Second, there was no way to verify that image was hitting $r = 0$, where r is the point from the center of the apodizer the image rays are focused in the plane of the apodizer. For instance, if the focal point was $r = 12$ mm on the $\sigma = 12$ mm apodizer the transmission intensity would drop by roughly half.

Since the goal of this particular experimental was not to measure the dynamic range improvement minimal background images were captured. A background image could have been collected for each of setting, aperture, and apodizer. With the background images and the unapodized image it would have been possible to calculate the improvement in dynamic range of the system. However, the electron beam would have to be turned off to capture the background images, and this would have complicated the setup and software, delaying the data collection process. Finally, the camera that was used was a dual sensor CCD GiGE camera. The two gains could be setup an images collected with both sensors to combine the images for further dynamic range improvement [5].

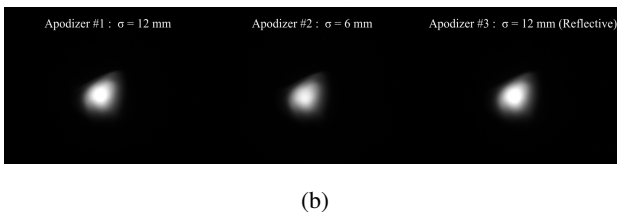
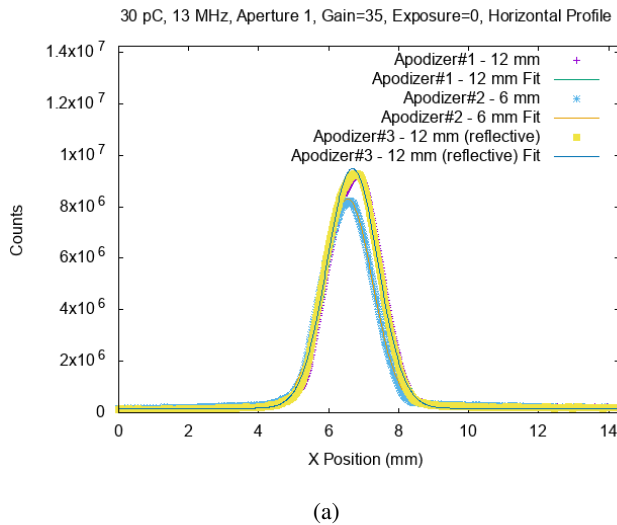

Figure 4: (a) Plot of Aperture #1 (1 degree of angular acceptance), all three apodizers. (b) Images used to generate above plot. Apodizers are $\sigma = 12$ mm, 6 mm, and 12 mm Reflective from left to right for same data set.

The apodizer transmission profile could have been measured ahead of time to characterize the transmission profile. The optical system could have been designed with beam splitters to image the same image on different sensors. Along, with the aforementioned improvements to the overall data collection another experiment will be planned to fully analyze the improvements that apodization can provide.

ACKNOWLEDGMENTS

Two days of beam time were used. The beam line setup and experiment went exceptionally well. A very big thanks to the staff at ELBE for helping to make this happen. This material is based upon work supported by the U.S. Department of Energy, Office of Science, Office of Nuclear Physics under contract DE-AC05-06OR23177.

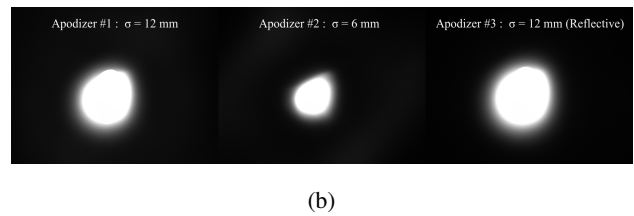
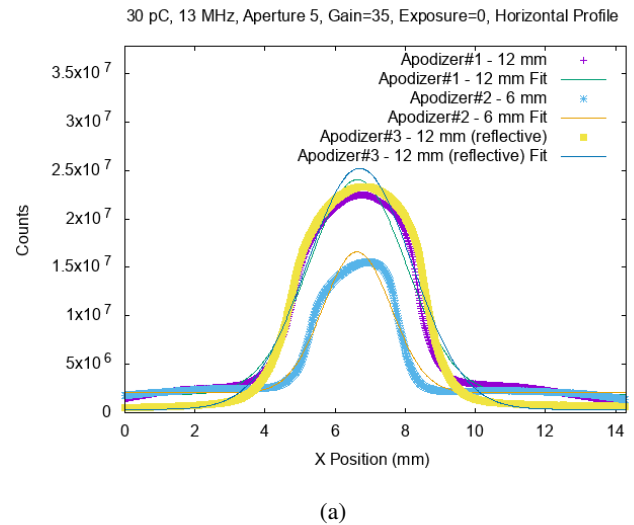

Figure 5: (a) Plot of Aperture #5 (5 degrees of angular acceptance), all three apodizers. (b) Images used to generate above plot. Apodizers are $\sigma = 12$ mm, 6 mm, and 12 mm Reflective from left to right for same data set.

REFERENCES

- [1] P. Evtushenko. Large dynamic range beam diagnostics for high average current electron linacs. *International Particle Accelerator Conference (IPAC) 2014 Proceedings*, pages 1900–1901, 2014.
- [2] P. Evtushenko. Jefferson lab specification 02122014-01, 2014.
- [3] JAI. Fusion series camera information. <https://www.jai.com/products/ad-081-ge>.
- [4] Wayne Rasband. Imagej users guide. <https://imagej.nih.gov/ij/>, 2012.
- [5] P. Evtushenko and D. Douglas. "high dynamic range beam imaging with two simultaneously sampling ccds". *International Beam Instrumentation Conference (IBIC) 2012 Proceedings*, pages 263–264, 2012.