

THE CONSTRUCTION STATUS OF THE SuperKEKB CONTROL SYSTEM

M. Iwasaki[#], A. Akiyama, K. Furukawa, H. Kaji, T. Naito, T. T. Nakamura, J. Odagiri, S. Sasaki,
KEK, Ibaraki, Japan

Y. Iitsuka, N. Yoshifuji, EJIT, Hitachi, Ibaraki, Japan

K. Asano, M. Hirose, KIS, Ibaraki, Japan

T. Aoyama, M. Fujita, T. Nakamura, K. Yoshii
Mitsubishi Electric System & Service Co. Ltd, Japan

Abstract

We have designed and upgraded the accelerator control system for SuperKEKB, the next generation B-factory experiment in Japan. The SuperKEKB control system is based on the features of the KEKB control system, while additional technologies have been implemented. In this paper, we report the construction status of the SuperKEKB accelerator control system.

INTRODUCTION

SuperKEKB is the upgrade of the KEKB asymmetric energy electron-positron collider for the next generation B-factory experiment in Japan [1]. The designed luminosity is to achieve a 40-times higher luminosity than the world record by KEKB. The KEKB operation finished in 2010 June to start the SuperKEKB accelerator construction. Currently the construction is in the final stage to prepare for the 1st operation in 2016 Feb. Here the accelerator operation will be performed in three stages, Phase 1, 2, and 3. The Phase 1 is for the vacuum scrubbing and basic machine tuning, and is the operation without the final focusing magnet system (QCS) nor the BelleII detector. After the Phase 1 operation, there will be Phase 2 and 3 operations with QCS and BelleII without (Phase 2) or with (Phase 3) the vertex detector.

The KEKB control system was based on EPICS (Experimental Physics and Industrial Control System) [2] at the equipment layer and scripting languages at the operation layer. The SuperKEKB control system continues to employ those features, while we implement additional technologies for the successful operation at such a high luminosity.

We have developed the interface modules to control thousands magnet power supplies, and introduce the EPICS embedded PLC, where EPICS runs on a CPU module. In the timing system, the new configuration for positron beams is required. The faster response abort trigger system has been developed. For the stable status monitoring, we have introduced the new alarm system based on CSS (Control System Studio) [3]. For Phase 2 and beyond, we have developed the new data archiving system based on CSS. The new VME-based FPGA module is also developed.

This paper describes the design and status of the SuperKEKB accelerator control system.

[#]masako.iwasaki@kek.jp

HARDWARE INTERFACE FOR SuperKEKB

For KEKB and SuperKEKB, EPICS is used as the main software to control the accelerator at the equipment layer. The EPICS framework consists of the Operator Interfaces (OPIs) and the Input/Output Controllers (IOCs). In KEKB, our system was constructed with the EPICS base version 3.13. For SuperKEKB, we're going to update to the version 3.14, however there still remain IOCs which are based on the EPICS base v3.13. For the operation layer, several script language of SAD script, python are used.

In KEKB, VME single board computers with VxWorks are mainly used as IOCs. For SuperKEKB, as well as the VME/VxWorks, the PLC (programmable logic controller) with a CPU module where Linux is running, and the Linux PC are also used as IOCs.

Figure 1 shows the picture of the PLC modules for the beam mask controller. In the CPU module (Yokogawa F3RP61), Linux is running, and we install EPICS into the CPU module to control the PLC. For SuperKEKB, the F3RP61 module is used to control the many devices of, for example, the vacuum system, LLRF, the automatic calibration subsystem of the large-type-magnet power supply, and beam collimators [4].

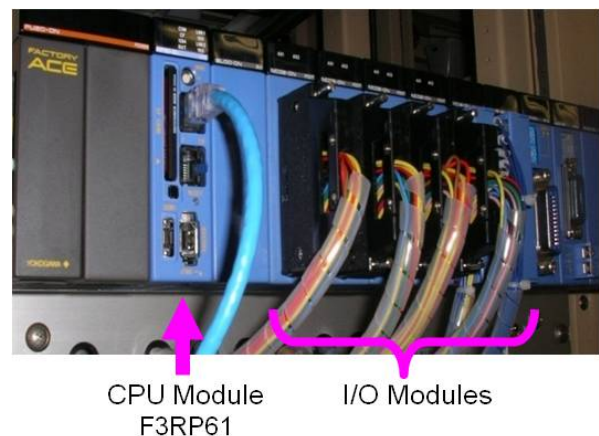

Figure 1: Picture of the PLC modules for the beam collimator controller.

There are many kinds of fieldbus in SuperKEKB accelerator components, such as Ethernet, GP-IB, serial, VXI/MXI for BPM, ARCNET for magnet power supply, and CAMAC. For the magnet-power-supply control, we have developed the PSICM (Power Supply Interface

Controller Module) for KEKB. In SuperKEKB, significant number power supplies have been newly installed, and we have upgraded the PSICM [5], which is fully backward compatible to the previous PSICM.

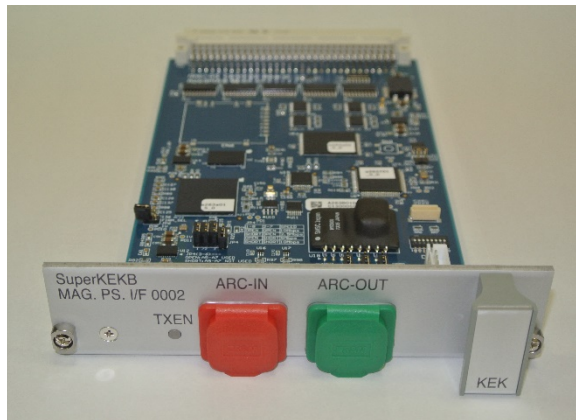

Figure 2: The upgraded PSICM (Power Supply Interface Controller Module), used for the magnet power supply control, for SuperKEKB.

Figure 2 shows the picture of the upgraded PSICM for SuperKEKB. The new PSICM has features of the faster data transfer rate of 10Mbps or 5Mbps in addition to the 2.5Mbps of KEKB, 32-bit data handling to support the 24, 20, or 18-bit resolution DAC (the previous PSICM supports 16-bit only), and redundant timing-signal inputs. For the Phase 1 operation, we use both old and new PSICM due to the budget limitation, and 426 new PSICM (out of the 2162 magnet power supplies in LER and HER) have been installed.

DATA ARCHIVING SYSTEM

In KEKB, we have used KEKBLog as a data archiving system. In SuperKEKB, we continue to use the KEKBLog which is the file based logging system, as a primary data archiving system. In addition, the new data archiving system based on the CSS [3] Archiver is also developed. CSS is originally developed at DESY, and has many general software components for the device control. CSS-based Archiver is one of the CSS tools, which collects data using the EPICS Channel Access protocol, and stores the data to the backend relational database system. Here we use PostgreSQL for the database system.

The database can be directly accessed with CSS. We have also developed the data browser program which directly accesses the database, based on the ROOT [6]. ROOT is the software framework based on C++ developed at CERN, and is used by many experiments in high-energy physics, astrophysics, etc. User's PC with CSS or the ROOT based browser can remotely access to the database for the real-time, historical, or trend data monitoring.

Currently, the CSS Archiver with the PostgreSQL backend database is running on our system. It collects the

vacuum system data and the QCS cryogenic data, and works without problem so far.

NEW ALARM SYSTEM

In KEKB, we used SAD based alarm system. For SuperKEKB, we have constructed the new alarm system based on the CSS BEAST alarm handler software [7]. The alarm system monitors the severity of EPICS records, and updates the database which shows the alarm status of the monitored EPICS records. The system also uses the other database for the alarm history logging. We use PostgreSQL for both databases. Figure 3 shows the schematic view of the alarm system.

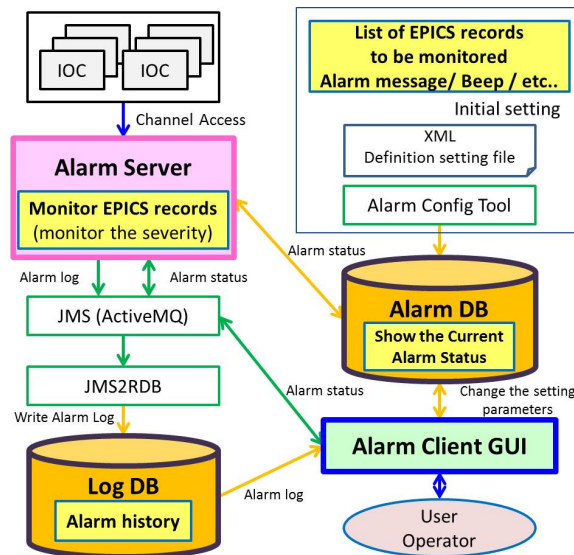

Figure 3: Schematic view of the new alarm system based on the CSS BEAST alarm handler software.

Though the CSS alarm system is already used in many accelerators, the evaluation test is important to ensure the new alarm system can stably operate under the SuperKEKB environment of several 10 thousands alarm points (~25,000 in KEKB). We did load tests using dummy records, and confirm the CSS alarm system works well under such huge number of monitoring points. We have also prepared the user interface software tools based on Python for the alarm system. Currently, the CSS alarm system is running on our system, and monitors the vacuum system data without any problem so far.

TIMING SYSTEM FOR SuperKEKB

In SuperKEKB, we construct the positron Damping Ring (DR) to produce the lower emittance beams. The KEKB timing system is based on a frequency divider/multiply and a digital delay technique. Since the KEKB ring RF (508.887MHz) is not a divisor of the Linac RF (2856 MHz), both of the KEKB ring and the Linac frequencies are locked with a common divisor frequency (10.385 MHz = 96ns cycle), which determines the injection timing. For the SuperKEKB positron injection, the injection timing of 96ns cycle for KEKB

becomes 11.34 ms, because of the properties of DR, if we use the similar configuration as KEKB.

Instead of this, we have developed the new timing system, which generates the injection timing signals [8]. Figure 4 shows the layout of the event timing system located at the Linac main trigger station for the SuperKEKB positron injection. The system consists with two layers of event generators (EVGs). As EVG detects

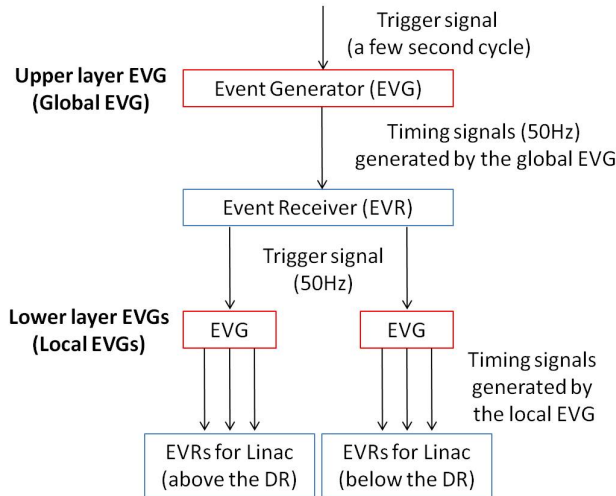

Figure 4: Layout of the event timing system at the Linac main trigger station for SuperKEKB positron injections.

the external trigger, EVG generates and sends the timing signal to the event receivers (EVRs). The trigger for the upper layer EVG (global EVG) is a coincidence between 50Hz and 11.34 ms cycle, which corresponds to a few second cycle. The global EVG sends the 50Hz timing signal for EVR. The EVR outputs 50Hz trigger signals to the lower layer EVGs (local EVGs). The local EVG for the Linac below the DR generates the timing signals, in taking account for the proper positron injections.

For SuperKEKB, we have developed the new Event modules, which are utilized to deliver triggers to the DR beam monitors. Figure 5 is a picture of the new Event Generator, VME-EVO, having 2 inputs and 8 outputs. The details of the VME-EVO module as well as the new Event Receiver VME-EVE, are described in Ref. [8]. The triggers for 84 DR beam position monitors will be managed with 5 new Event modules.



Figure 5: The new Event Generator, VME-EVO.

ABORT TRIGGER SYSTEM

We have developed the faster response abort trigger system for SuperKEKB [9]. Figure 6 shows the layout of the abort trigger system.

There are over 130 points which monitor the beam status and issue the abort signal. The abort signal is E/O converted, and received by the VME abort modules located at the local control rooms. 20 local abort modules are connected to the abort module in the SuperKEKB control room, which gathers the local abort module signals, takes OR of them, and issues the trigger signal to the abort kicker.

In KEKB, these modules are connected with wires, and low pass filters which caused time delay of $\sim 100\mu\text{s}$ were necessary for the noise reduction. For SuperKEKB, we have adopted the E/O conversion, replaced the wires with the optical cables to transfer the signal, and removed the low pass filters from the system. The total abort trigger system response time is improved to 20 μs .

Based on the feasibility tests with a prototype module, the new module design has been improved and fixed. The new system has been partially installed and has worked with the previous system.

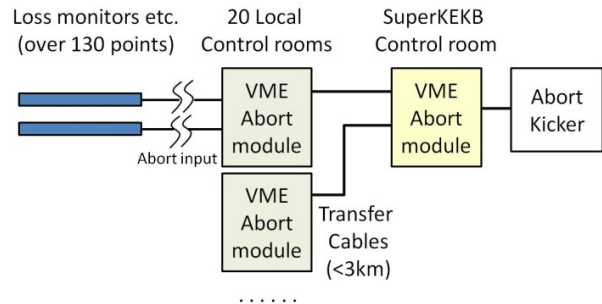

Figure 6: Layout of the SuperKEKB abort trigger system.

NEW SIGNAL TRANSFER SCHEME WITH FPGA BOARD

We have developed the new signal transfer scheme for the communication between SuperKEKB and the BelleII detector, e.g. injection control. In KEKB, we transfer E/O converted signals via $\sim 2\text{km}$ length optical cables for the accelerator and detector communication. In SuperKEKB, the number of signals to be transferred increases, while the above signal transfer scheme requires the same number optical cables as the signals to be transferred.

To save the optical cable, we have developed the new signal transfer scheme using FPGA, based on digital sampling, parallel to serial, and serial to parallel conversions, shown in Figure 7. We use SFP(+) for the optical signal interface. The number of the optical cables in this system is reduced to two, for incoming and outgoing signals, as shown in Figure 8. Since SFP has the signal transfer bandwidth of 1 Gbps (~ 5 Gbps for SFP+), the digital sampling rate of higher than MHz, which is the higher rate than the beam revolution frequency of 100 kHz, is possible in this scheme.

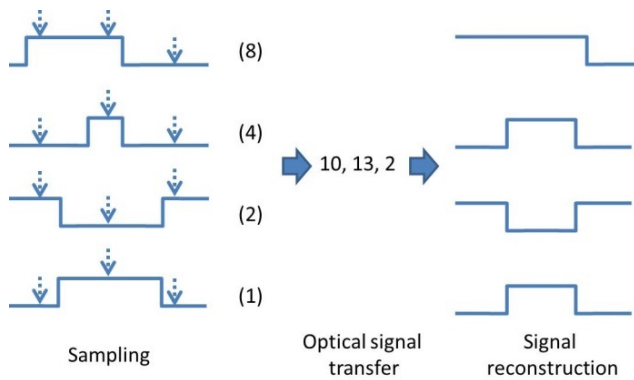

Figure 7: Injection-control signal transfer scheme for SuperKEKB.

In this scheme, we use a general purpose VME module with an FMC (FPGA Mezzanine Card) interface which is developed for Spring-8 [10], with a TTL-NIM-IO mezzanine card for NIM level and LVTTTL signal IOs which is developed for SuperKEKB [11].

We also apply the combination of the VME module with a TTL-NIM-IO mezzanine card for several systems, the beam gate open/close request signal transfer between SuperKEKB and injector Linac, the software abort request system, the quench detection system for QCS, etc. The first processing of the VME module with an FMC and the TTL-NIM-IO mezzanine card was done in 2014-2015, and several evaluation tests are carried out [12].

Both the VME module and the TTL-NIM-IO mezzanine card are developed as a project of Open-It (Open Source Consortium of Instrumentation [13]).

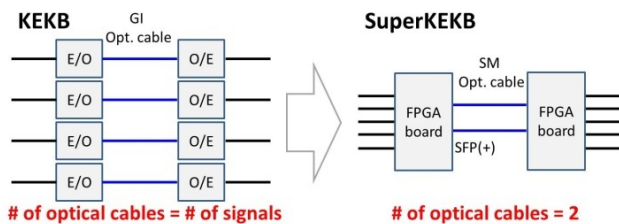

Figure 8: Injection-control signal transfer methods for KEKB and SuperKEKB.

RENOVATION OF THE CONTROL AND COMPUTING ROOMS

We did renovation of the control and the computing rooms in 2013-2014 for SuperKEKB. We removed old panel-board cabinets and server racks from the computing room. We installed new server racks and new power supply modules which are located in the new server racks. We also installed the new consoles into the SuperKEKB control room.

SUMMARY

We have improved the accelerator control system for SuperKEKB operations under the 40-times higher luminosity than the world record achieved by KEKB. Based on the KEKB accelerator control system, we have implemented the new features of the improved control hardware and software tools and interfaces, the new data archiving system, the new alarm system, the new timing system, the faster response abort trigger system, and the new signal transfer scheme based on FPGA. We have also renovated the computing and main control rooms and have been preparing for the SuperKEKB Phase 1 operation in 2016 Feb.

ACKNOWLEDGMENT

We thank T. Abe (Spring-8), M. Ikeno and M. Shoji (KEK) on the VME-FPGA module development, for their technical supports as a project of Open-It.

REFERENCES

- [1] SuperKEKB Task Force, Letter of Intent for KEK Super B Factory, KEK-REPROT-2004-4, Jun. 2004. Belle II Collaboration, KEK-REPORT-2010-1, Nov. 2010.
- [2] EPICS, <http://www.aps.anl.gov/epics/>
- [3] CSS, <http://www.aps.anl.gov/epics/eclipse/>
- [4] J. Odagiri et al., “Integration of PLC with EPICS IOC for SuperKEKB Control System”, ICALEPCS2013, San Francisco, CA, USA, Oct. 2013, p. 31 (2013).
- [5] T.T. Nakamura et al., “The Construction of the SuperKEKB Magnet Control System”, presented at ICALEPCS2015, Melbourne, Australia, paper WEPGF085, *these proceedings*.
- [6] ROOT, <https://root.cern.ch/>
- [7] K. Kasemir, X. Chen, E. Danilova, “The Best Ever Alarm System Toolkit”, ICALEPCS2009, Kobe, Japan, Oct. 2009, p. 46 (2009).
- [8] H. Kaji et al., “New Event Timing System for Damping Ring at SuperKEKB”, presented at ICALEPCS2015, Melbourne, Australia, paper WEC3004, *these proceedings*.
- [9] S. Sasaki et al., “Upgrade of Abort Trigger System for SuperKEKB”, presented at ICALEPCS2015, Melbourne, Australia, paper MOPGF141, *these proceedings*.
- [10] T. Abe et al., “Development and Application of VME module with FMC Interface (1) - Design of the VME module and application to Spring-8 -”, 12th annual Meeting of Particle Accelerator Society of Japan, Fukui, Japan, Aug. 2015, p.1299 (2015).
- [11] M. Iwasaki et al., “Development and Application of VME module with FMC Interface (2) - Application to SuperKEKB -”, *ibid.*, p.1286.
- [12] S. Sasaki et al., “Development and Application of VME module with FMC Interface (3) - Evaluation tests for SuperKEKB -”, *ibid.*, p.1266.
- [13] Open-It, <http://openit.kek.jp>