

# DESIGN OF THE CERL VACUUM SYSTEM

Y. Tanimoto<sup>#</sup>, S. Asaoka, T. Honda, T. Nogami, T. Obina, R. Takai, KEK, Tsukuba, Japan

## Abstract

The compact Energy Recovery Linac (cERL) is being constructed as a test accelerator for the ERL-based future light source at KEK. Low emittance (0.1 mm·mrad) and high current (10-100 mA) beams will be generated at a 500-kV electron gun, and accelerated up to 125 MeV (initially 35 MeV) at superconducting (SC) RF cavities, in which the energy recovery is made. The vacuum system is required to accommodate such high intensity and ultra-short bunch (<0.1 ps) beams, and designed so as to reduce wake fields. Therefore, low impedance vacuum components, such as gapless and stepless flanges and RF-shielded screen monitors, have been developed. Ultra-high and dust-free vacuum is required in the vicinity of the SC cavities to maintain highly stable CW operation, and these beam ducts are coated with Non-Evaporable Getter (NEG) film. Because of the low beam energy, synchrotron radiation (SR) absorbers are not necessary and the beam ducts can be made of stainless steel. However, the SR scrubbing effect is so limited that the beam ducts should be ready for in-situ bakeout and those inside the magnets are wrapped with film heaters, which is also useful for the NEG-coating activation.

## INTRODUCTION

The cERL is a small accelerator but incorporates key technologies (a high brightness electron gun, high stability CW SC cavities, etc.) to be demonstrated for an ERL-based future light source. Main parameters of the cERL are listed in Table 1.

As shown in Fig. 1, the cERL accelerator consists of four parts: 1) 5-MeV injector, 2) diagnostics line, 3) main linac return loop, and 4) dump line. The injector and the diagnostics line have been already constructed, and beam commissioning has started in April 2013 [1]. The main linac return loop and the dump line will be constructed

after the injector commissioning, and the first 35-MeV beam is expected to circulate by the end of 2013 [2]. Most of the vacuum components have been already designed and manufactured. Some of the design details are described in the following sections.

Table 1: Main Parameters of the cERL

Stage	Initial	Next
Beam energy (MeV)	35	125
Beam current (mA)	10	100*
Normalized emittance (mm·mrad)	1	0.1*
Bunch length, rms (ps)	1 - 3	< 0.1*
Bunch repetition rate (GHz)	1.3	
Circumference (m)	92	

\* These values are targeted in each specialized mode.

## LOW IMPEDANCE VACUUM COMPONENTS

As given in Table 1, the cERL vacuum system is required to accommodate high current, low emittance, and short bunch beams. In order to mitigate beam breakup (BBU) and chamber heating caused by such beams, low impedance vacuum components need to be employed.

### Gapless and Stepless Flange

Beam ducts in straight sections are typically  $\phi 50$ -mm round tubes, and we have developed a special flange to connect these tubes seamlessly. The sealing mechanism is illustrated in Fig. 2; on the left, a copper gasket is inserted between a pair of identical stainless steel flanges, and on the right, after the flanges are jointed, neither gap nor step can be seen from the beam. A similar structure had been already developed for SC cavities at KEK [3].

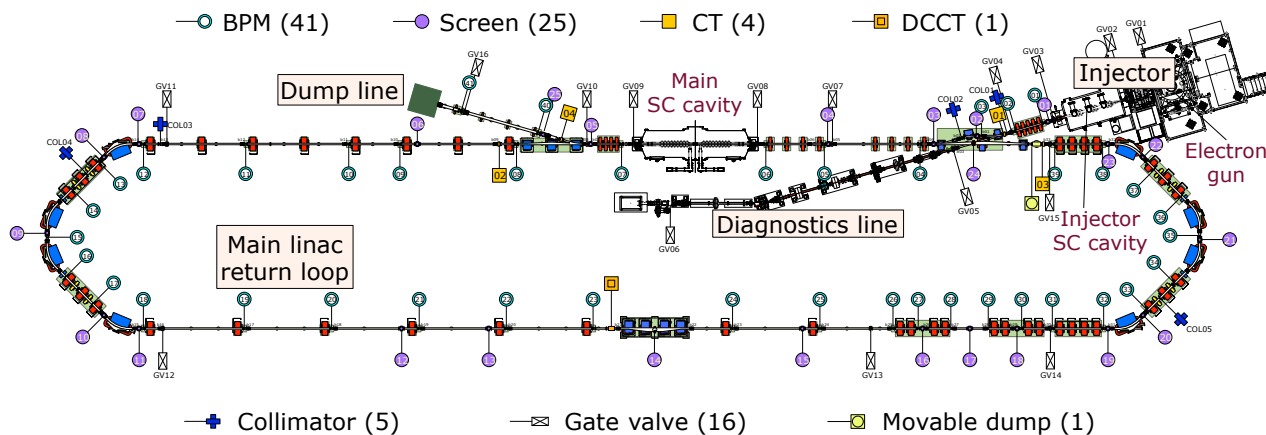

Figure 1: Schematic layout of the cERL.

<sup>#</sup> yasunori.tanimoto@kek.jp

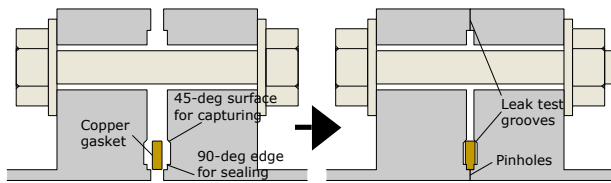

Figure 2: Sealing mechanism of the cERL flanges when a copper gasket is used.

In the annular gasket groove, the 90-deg edge is designed to ensure leak-tight sealing by cutting into the copper gasket, and the 45-deg surface is designed to "capture" the gasket aiming at maintaining leak-tightness even after repetitive bakeout cycles.

In the initial design, dowel pins were used for accurate alignment, but in the prototype testing we found them not having sufficient rigidity ( $\sim 10 \mu\text{m}$ ). Then, we decided to use a metal clamp that fits with the outer periphery of the  $\phi 114$  flange. In this case, a rotatable flange cannot be used, so we enlarged the diameter of bolt holes from the standard  $\phi 8.4$  to  $\phi 10$ , by which a little rotation of the tubes is allowed.

Bolts are tightened until the flange touches each other. This can be normally achieved by five cycles of tightening with a torque up to 15 N·m. For this reason, annealed copper gaskets (Hv $\sim$ 40) are preferred. Alternatively, an aluminum jacket O-ring with an elastic coil spring, such as U-tightseal or Helicoflex, can be seated in this flange. As shown in Fig. 3, the flat surface in each gasket groove compresses the O-ring and conduces to leak-tight sealing.

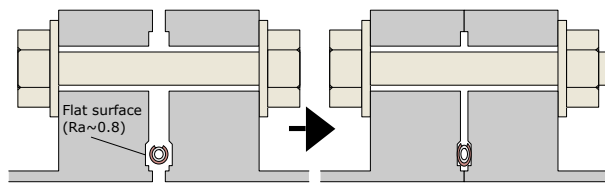

Figure 3: Sealing mechanism of the cERL flanges when a metal O-ring is used.

The same sealing structure can be applied to beam ducts that have other cross-sections than round. Figure 4 shows the two types of flanges used in the cERL.

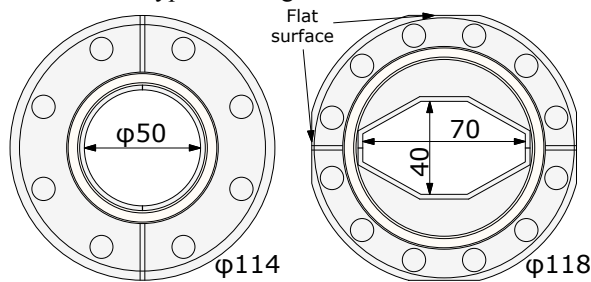

Figure 4: Two types of flanges for the cERL beam ducts: (left) round cross-section for straight sections, (right) oblong octagon for arc sections.

Beam ducts in arc sections have oblong octagon cross-section. In this case, however, rotation of the ducts is

basically not allowed in flange connection, so we use flat surfaces on the top, bottom, left and right of the flange periphery for alignment.

We have repeatedly tested these flanges, and obtained excellent vacuum performance; the leak-tightness was maintained also after the bakeout at 200°C for 24 hours and the pressure reached  $2 \times 10^{-8}$  Pa.

### RF-shielded Screen Monitor

Measurement of transverse beam profiles is essential in the operation of linacs, and approximately 30 screen monitors will be installed in the cERL. We have developed an RF-shielded screen monitor by modifying the designs employed at JLab and BNL [4, 5].

As shown in Fig. 5, the screen monitor is equipped with an RF-shield tube and two kinds of radiators, namely, YAG:Ce single crystal in the upper holder and aluminum-coated silicon for optical transition radiation (OTR) monitoring in the lower holder. These screens move in vertical directions, and are concealed behind the RF-shield tube while being not used. The movement is powered by compressed air, and each position changes smoothly within five seconds.

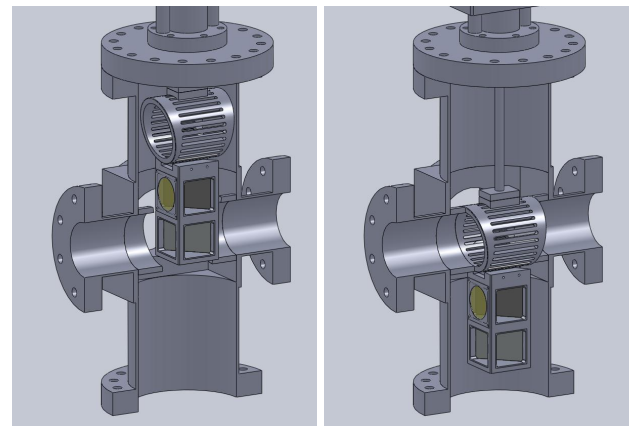

Figure 5: RF-shielded screen monitor for the cERL: (left) the OTR foil is at monitoring position, (right) the screens are concealed behind the RF-shield tube while unused.

From the point of view of RF-shielding, it is important to ensure the contact between the RF-shield tube and the adjacent beam tubes. The contact surfaces are precisely machined (typically  $10 \mu\text{m}$ ), and residual stress generated during machining and welding is relieved by annealing at over 600°C in a vacuum furnace. Precise fitting of the RF-shield tube can be achieved by tilt and position adjusters. A similar RF-shielding structure has been applied to the cERL movable beam dump.

### PRESSURE REQUIREMENTS

In the cERL, the photocathode electron gun requires an extreme high vacuum of  $1 \times 10^{-10}$  Pa to preserve a sufficiently long cathode lifetime in high current operations at over 10 mA [6]. The SC cavities in the injector and in the main linac require low pressures below  $1 \times 10^{-8}$  Pa to minimize gas condensation on cryo surfaces. For lack of enough space for lumped pumps, the beam

ducts in the vicinity of the SC cavities are NEG-coated (Fig. 6). In addition, these SC cavities need to be operated in a dust-free environment, so the vacuum components are cleaned by an air gun in a class-10 cleanroom, and then assembled in a mobile cleanbooth.

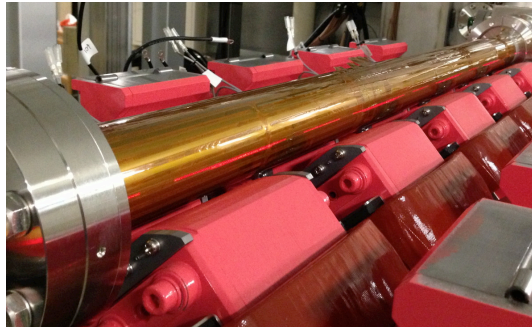

Figure 6: NEG-coated tube installed inside a series of quadrupole magnets near the injector SC cavity. The tube is wrapped with film heaters for activation.

Pressure requirement in the other regions is  $1 \times 10^{-7}$  Pa to mitigate beam-gas interactions, namely, ion trapping and beam loss. The beam ducts are pumped by lumped NEG pumps and sputter ion pumps. For example, Figure 7 is a schematic drawing of a typical dipole chamber in the arc section; one or two NEG modules are installed in each dipole chamber, and the SR port will be utilized for beam diagnostics using visible lights.

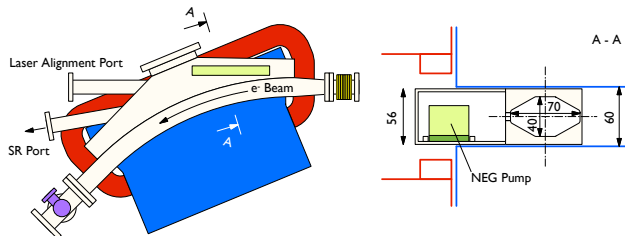

Figure 7: A dipole chamber in the arc section.

Even while a 125-MeV, 100-mA beam is circulating, the total power of incoherent SR is only 2.2 W. In a short bunch mode (e.g. the bunch length is 1 ps), coherent SR (CSR) becomes predominant, but its total power is estimated at as low as 77 W (125 MeV, 10 mA). Therefore, no particular measures against SR heat loads are required, and we employed 316L stainless steel as a main material of the beam ducts.

This means, however, that the SR scrubbing effect is very limited, and the entire vacuum system should be ready for in-situ bakeout. Most of the beam ducts installed inside the magnets are wrapped with film heaters, as shown in Fig. 6. The thickness of the heater is 250  $\mu\text{m}$ , within which etched 304 stainless steel foil is laminated with polyimide (Kapton) films. These heaters have a relative magnetic permeability of 1.005, and are capable of raising tube temperature up to 200°C, which is also useful for NEG-coating activation.

We calculated pressure profiles along the beam orbit in the main linac return loop, assuming that the outgassing rate of buffed and electropolished stainless steel is reduced to  $5 \times 10^{-9}$  Pa  $\text{m}^2 \text{s}^{-1} \text{m}^{-2}$  after the bakeout. One of

the results is shown in Fig. 8. The pump configuration has been determined so as to meet the pressure requirements.

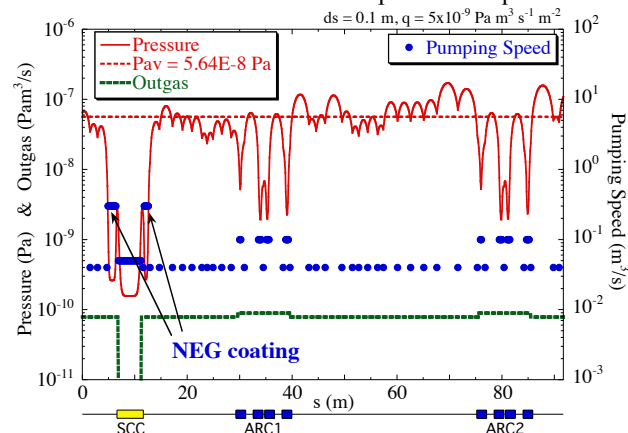

Figure 8: Calculated pressure profile in the main linac.

### SUMMARY

The cERL vacuum system has been designed so as to circulate high current and short bunch electron beams without degrading the low beam emittance. For this purpose, we have developed some low impedance vacuum components such as flanges and screen monitors. NEG coating was adopted in the vicinity of the SC cavities to create a pressure lower than  $1 \times 10^{-8}$  Pa.

After the construction of the entire accelerator, beam commissioning will start by the end of 2013, in which the performance of the vacuum components will be examined.

### ACKNOWLEDGMENTS

Adoption of NEG coating was encouraged by instructive discussions with the CERN vacuum group, especially P. Costa Pinto, P. Edwards, M. Taborelli, P. Chiggiato, and J.M. Jimenez. The NEG tubes were coated at ESRF, and the authors are grateful for the corporation of M. Hahn, H.P. Marques, and F. Bodart.

### REFERENCES

- [1] T. Miyajima, "Beam Commissioning of Energy Recovery Linacs," FRXBB201, these proceedings.
- [2] S. Sakanaka et al., "Progress in Construction of the 35-MeV Compact Energy Recovery Linac at KEK," WEPWA015, these proceedings.
- [3] K. Saito, F. Furuta, T. Konomi, "Application of MO Sealing for SRF Cavities," IPAC'10, Kyoto, May 2010, WEPE009, p. 3359 (2010).
- [4] P. Evtushenko et al., "Electron Beam Diagnostics of the JLab UV FEL," PAC'11, New York, March 2011, WEOCN4, p. 1446 (2011).
- [5] D. M. Gassner et al., "BNL Energy Recovery Linac Instrumentation," ERL'11, Tsukuba, October 2011, WG4003 (2011).
- [6] M. Yamamoto et al., "Extreme High Vacuum System of High Brightness Electron Source for ERL," IPAC'11, San Sebastián, September 2011, TUODB02, p. 979 (2011).