

DEVELOPMENT OF CO₂ LASER OPTICAL ENHANCEMENT CAVITY FOR A LASER-COMPTON X-RAY SOURCE *

K. Ando[†], N. Takeichi, K. Sakaue, A. Endo, M. Washio,
Waseda University, Tokyo, Japan

Abstract

We have been developing a laser-Compton X-ray source using an optical enhancement cavity. We have studied 1 μm pulse laser storage in optical cavity and use for the experiments. Usage of 10 μm laser for optical enhancement cavity will increase the X-ray energy region of one laser-Compton X-ray source, so that we decided to develop the optical cavity for CO₂ laser. We have designed external optical cavity for CO₂ laser commercially available optics and verified the enhancement of CO₂ laser in external enhancement optical cavity, and measured fundamental parameters such as finesse, matching efficiency, and enhancement factor. We have already achieved 475 of finesse, 43 of enhancement, and tested non-planer cavity, which storages two circular polarization separately. In this conference, we will report the design and experimental results of CO₂ laser storage cavity and also some future prospects.

INTRODUCTION

A collision between laser and relativistic electron beam generates high energy photons. That process is called laser-Compton scattering[1]. We are developing a laser-Compton X-ray source by collision of IR laser and accelerated electron beam. The energy of scattering X-ray E_s , the scattering angle θ , and the photon number of the X-ray N_s are given by

$$E_{smax} = 2E_0\gamma^2(1 - \beta\cos\varphi) \quad (1)$$

$$\theta = \frac{1}{\gamma} \sqrt{\frac{E_{smax} - E_s}{E_s}} \quad (2)$$

$$N_s \propto N_l \quad (3)$$

where E_0 is the energy of IR laser, γ is Lorentz factor, φ is collision angle, and N_l is the photon number of IR laser.

When target E_s was fixed, small E_0 leads large γ as shown in Eq.(2). Large γ makes the scattering angle θ small. Then it enlarges the brightness of scattering X-ray. On the other hand, longer wavelength laser has larger photon number in same power than that of shorter wavelength. Then, longer wavelength makes larger photon number of scattering X-ray by Eq.(3).

CO₂ laser has about ten times long wavelength as widely used 1 μm solid state lasers. Thus, usage of CO₂ laser for collision laser of laser-Compton scattering has large possibility of gaining photon flux and brightness. So, we started the study of CO₂ laser Enhancement cavity.

*Work supported by NEDO (New Energy and Industrial Technology Development Organization).

[†]k.andou@fuji.waseda.jp

After the verification of enhancement, we tested non-planar four mirrors cavity for 1 μm YAG laser as preliminary experiment.

ENHANCEMENT CAVITY

Enhancement optical cavity is an optical configuration to store the injecting laser in two or more mirrors. The cavity circumference must be integral multiplication of laser's wavelength to achieve the enhancement. Relation of laser power in cavity and cavity length is called Airy function as

$$I = \frac{I_{max}}{1 + (2F/\pi)^2 \sin^2(kD)} \quad (4)$$

where I is stored power, D is cavity length, k is wavenumber, and F is finesse. Figure 1 shows an example of Airy function at 100 of finesse, and 10.23 μm of laser wavelength.

Finesse is one of important cavity parameter, which indicates smallness of loss on storing laser. Large finesse makes the Airy peak sharp. On the other hand, enhancement factor is another important parameter of cavity. It is defined as the ratio of stored power to the input laser power. Finesse is a cavity parameter depending on mirror reflectance. Finesse and transmission of cavity mirror decides the enhancement factor. Of course, a large finesse leads to a large enhancement factor.

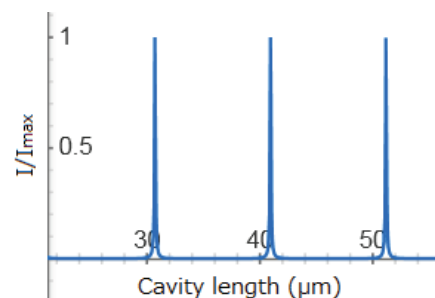

Figure 1: Airy function at 100 of finesse.

Experimental Setup

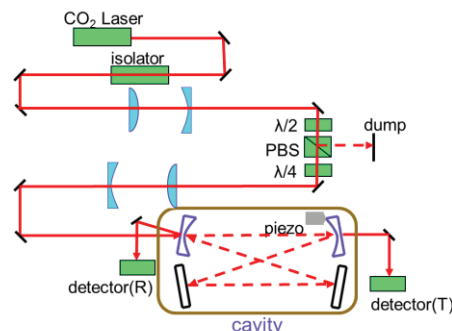

Figure 2: Setup of CO₂ laser storage system.

Figure 2 shows the setup of CO₂ laser storage system. We used a CW CO₂ laser, which has 10.23 μm of wavelength and average power of 10W. We made four-mirrors cavity, and tested two cavities with different finesse using two different reflectivity mirrors. Table 1 shows the reflectivity of mirrors used to configure low finesse cavity and high finesse cavity and their calculated finesse. One mirror is mounted on a piezo actuator in order to scan the cavity length and lock on the resonance.

Table 1: Calculated Parameter of Cavities

	Concave mirror	Flat mirror	Finesse
LF Cavity	99.5 %	99.8 %	448
HF Cavity	99.6 %	99.8 %	523

Experimental Results

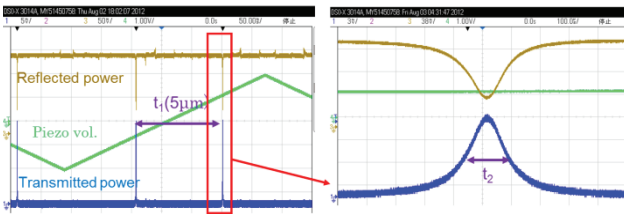

Figure 3: transmittance and reflectance of cavity

Firstly, we observed Airy function by scanning piezo actuator by triangle voltage. Figure 3 shows the transmitted power and reflected power while scanning the cavity length. Clear Airy function has been observed. This is one of the verifications of CO₂ laser storage in external optical cavity. After ensuring CO₂ laser storage, we measured finesse from the Airy function. With t_1 of free spectrum range and t_2 of FWHM of Airy peak (as shown in figure 4), finesse is given by

$$F = t_1/t_2 \tag{5}$$

Table 2 shows the results of finesse measurement. Measured finesse was slightly lower than expected value. Table 2 was based on specification of mirrors, thus we will perform reflectivity measurement by ourselves and check this differences.

Table 2: Measured Finesse

	Measured finesse
LF cavity	381.2 ± 13.8
HF cavity	474.8 ± 18.9

Secondly, we measured enhancement factor and stored power. Figure 4 shows the image of laser storing test for measuring the stored power and enhancement factor. By measuring the transmitted power P_{out} and transmittance of output mirror, we can achieve the stored power inside the cavity.

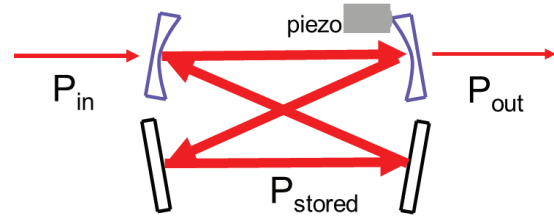

Figure 4: Image of storing laser test.

Enhancement can be also calculated by dividing input power into stored power. Figure 6 shows the stored power vs. input laser power at low finesse and high finesse cavity, respectively.

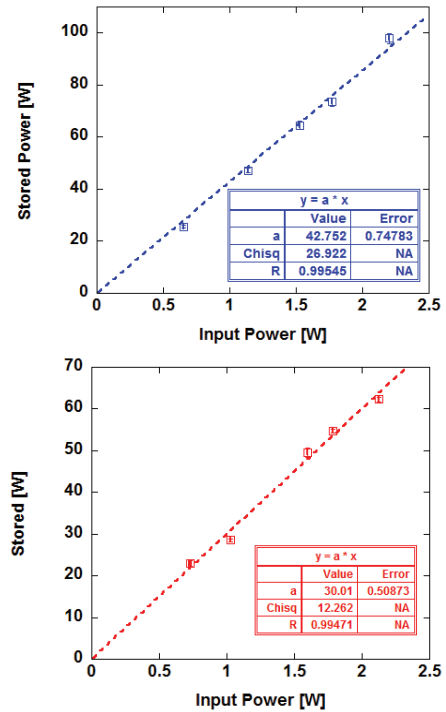

Figure 5: Result of measure of enhancement factor above: LF cavity below: HF cavity.

Table 3: Measured and Calculated Enhancement Factor

	Measured	Calculated
LF cavity	42.75	46.7
HF cavity	30.01	58.2

The slopes of these plots correspond to the enhancement factors of the cavities. Table 3 shows the results of enhancement factor and the expected value by the results of Table 2. The results are well agreed with the expected values. In this series of enhancement cavity measurement, we succeeded in demonstrating the optical enhancement cavity at 10μm lasers, and confirming the enhancement of 50 and stored power of more than 100 W inside the cavity.

NON-PLANAR FOUR MIRROR CAVITY

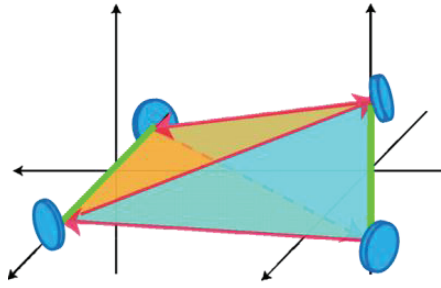

Figure 6: Non-planar cavity.

Non-planar four-mirror cavity is a cavity structure to store right- and left-handed circular polarization separately[2][3]. In laser-Compton scattering, laser polarization is transferred to scattered photon beam. Therefore, the cavity, which has the possibility to quick switch the right- and left-handed circular polarization, is quite useful to observe samples, which have circular dichroism. When cavity mirrors are set as figure 6, image rotation on reflection at mirror makes phase difference between left- and right-handed circular polarizations. It is called geometric phase. Geometric phase lengthen or shorten cavity length at Airy peak, and splits the Airy function. Thus, two circular polarizations are separately stored. Moreover, the differential signal of reflected light separated by polarized beam splitter is useful to lock the cavity length at the resonant peak. Figure 7 shows the sum and differential signal of a reflected light with finesse 240, 0.0327 rad of geometric phase. The differential signal crosses zero at peak of resonance, which can be used for the feedback error signal. Then we can lock the cavity length at resonance of a desired one circular polarization. After confirming storage of CO₂ laser in optical cavity, we started a study of non-planar four-mirror CO₂ laser cavity. As the first step, we started by using 1 μm YAG laser.

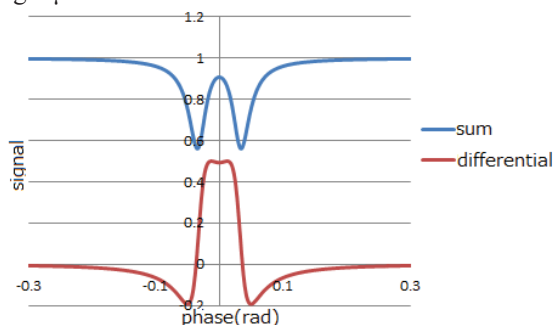

Figure 7: Reflected signal of non-planar cavity.

Experimental Setup

In this experiment, we used 1 μm CW YAG laser. Cavity was composed with 99.0 % of reflectivity, 420 mm of curvature concave mirrors and 99.7 % of reflectivity planar mirrors. Figure 8 is the photo of non-planar cavity. All distances between mirrors are 500mm, and whole cavity length is 2 m. Geometric phase is designed to be 0.0327 rad.

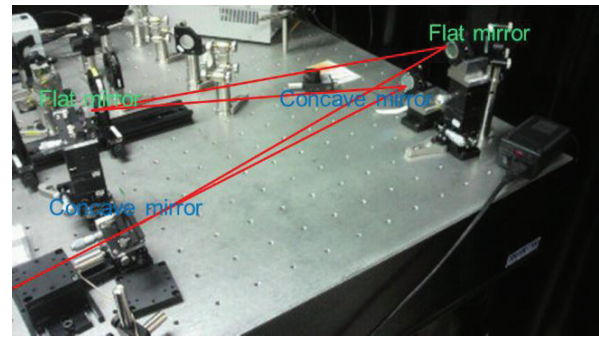

Figure 8: Non-planar optical cavity experiment.

Experimental Results

Figure 9: Transmitted power of a non-planar cavity.

Figure 9 is the Airy function of a non-planar cavity. We observed Airy peak split clearly. Measured geometric phase was 0.0254 ± 0.0029 rad. Measured geometric phase is far different from designed, however the geometric phase is sensitive to the reflecting angle in the cavity. We will confirm this geometrical phase difference at the next studies.

CONCLUSIONS

We have composed a CO₂ laser enhancement cavity, and verified the coherent storage. 475 of finesse and 50 of enhancement was successfully achieved, and 100W CO₂ laser storage was demonstrated. On the other hand, we have composed non-planar four-mirror cavity using 1 μm YAG laser, which is very useful for a polarized laser-Compton scattering source. We confirmed the phase difference between right- and left-handed circular polarizations and separately stored in the non-planar cavity.

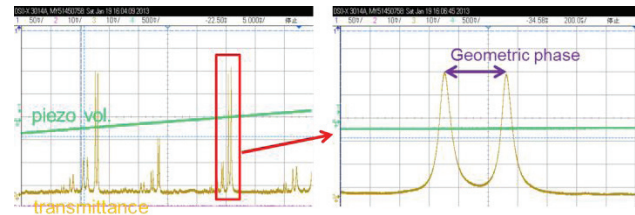
In the next step, we will test the non-planar four-mirror cavity with CO₂ laser, and develop ultra-small waist cavity by using off-axis parabolic mirrors.

REFERENCE

- [1] K.Sakaue et al., Radiat. Phys. Chem.77.1136-1141(2008).
- [2] T.Akagi et al., Proc. of IPAC'12, WEP005.
- [3] Y.Honda et al., Optics Communications282 3108-3112.