

MAGNET DESIGN FOR THE TARGET SYSTEM OF A MUON COLLIDER/NEUTRINO FACTORY*

R.J. Weggel,[†] Particle Beam Lasers, Northridge, CA 91324, USA
 H.G. Kirk, Brookhaven National Laboratory, Upton, N 11973, USA
 V.B. Graves, Oak Ridge National Laboratory, Oak Ridge, TN 37830, USA
 K.T. McDonald, Princeton University, Princeton, NJ 08544, USA

Abstract

The Target System and Pion Decay Channel for a Muon Collider/Neutrino Factory utilizes a string of solenoid magnets to capture and transport the low-energy pions whose decay provides the desired muon beams. The magnetic field strength at the target is 15-20 T, “tapering” down to 1.5-3 T in the Decay Channel. The superconducting coils which produce these fields must have substantial inner radius to accommodate internal shielding against radiation damage by secondary particles. A significant fraction of the primary beam energy is transported into the Decay Channel via protons, and the Decay Channel includes a magnetic chicane to provide a beam dump for these. The design of the various coils in this scenario is reported.

INTRODUCTION

In a muon accelerator complex such as a Muon Collider [1, 2, 3] or a Neutrino Factory [4, 5, 6], a target is bombarded by a multi-MW proton beam to produce pions that decay into muons, which are thereafter bunched, cooled, and accelerated. The Front End of the complex, sketched in Fig. 1, includes the Target System, the Decay Channel, the rf Buncher and Phase Rotator, and may include an initial section of ionization cooling (Cooler). These subsystems capture and manipulate the phase space of pions produced in the target, and that of the muons into which they decay, in a solenoidal magnetic channel to maximize the number of muons within the acceptance of the downstream acceleration system. For a channel of a given radius, more particles are captured by a higher solenoid field, with higher-transverse-momentum particles captured if the magnetic field at the target is higher than that in the subsequent channel. This improvement in the capture efficiency is associated with an increase in the longitudinal phase space of the captured particles, which can be disadvantageous for transport through RF cavities in the complex. Simulations [7] have shown that a relatively rapid decrease (taper) from high to low field along the Front End channel optimizes its performance.

The present concept [8] for the Target System for a Muon Collider/Neutrino Factory is for a graphite target inside a

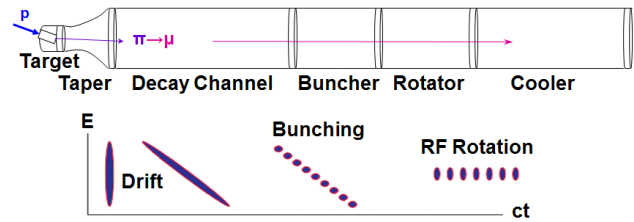

Figure 1: Layout of the Front End (prior to net acceleration of muons) of a muon accelerator, indicating schematically the target, magnetic-field taper, Decay Channel, Buncher, Phase Rotator and (ionization) Cooler. The transformation of the initial macrobunch with large energy spread produced at the target into a train of microbunches with common central energies is sketched in the lower part of the figure.

20-T solenoid field, which field tapers down to 2 T, used throughout the rest of the Front End, over 5 m, as sketched in Fig. 2. The yield of muons from the target is maximal at low kinetic energies, roughly $40 < KE < 180$ MeV, which particles emerge at large angles to the proton beam, favoring a cylindrical target of small radius, and tilted slightly with respect to the magnetic axis to minimize reabsorption of particles if their helical trajectory passes through the target a second time [9].

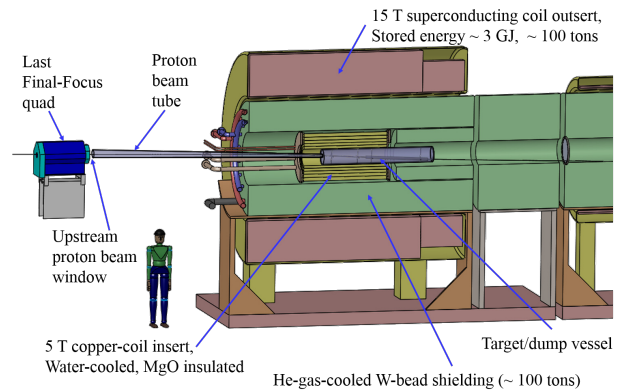

Figure 2: Sketch of the Target System concept.

The solenoid field is to be provided by superconducting coils (with cable-in-conduit conductor as used in the

Content from this work may be used under the terms of the CC BY 3.0 licence (© 2014). Any distribution of this work must maintain attribution to the author(s), title of the work, publisher, and DOI.

*Work supported by the US DOE Contract No. DE-AC02-98CH10886.

[†] bob.weggel@mindspring.com

ITER project [10]), except for a 5-T resistive coil insert (with Mg/spinel insulation as used at J-PARC [11]) near the target. Radiation damage (particularly to organic insulators) limits the dose on the superconducting coils to about 10 MGy [12], which translates to a peak power deposition of about 0.1 mW/g for a 10-year operations lifetime of 10^7 s/year. To achieve this performance, superconducting coils must have internal shields, here taken to be tungsten beads cooled by He gas flow. The required shielding is substantial [13, 14], and leads to an inner radius of the superconducting coils of 1.2 m near the target; consequently the energy stored in the 20-T coils is about 3 GJ.

TARGET SYSTEM MAGNETS

The parameters of the present design of the Target System magnets are listed in [15].

The magnets are arranged in modules, with the first three modules shown in Fig. 3. The first module, shown also in Fig. 4, surrounds the target and includes a 5-T resistive coil insert as well as two outer superconducting coils that add 15 T to bring the total field on target (centered on $z = 0$) to 20 T.

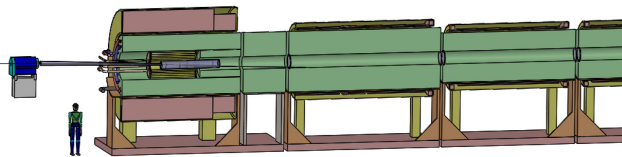

Figure 3: The first three Target System magnet modules.

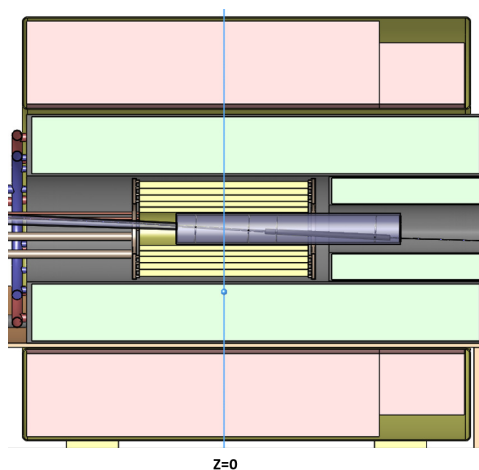

Figure 4: Section of the first magnet module, with the 5-T resistive coil insert and two superconducting outserts. The field is 20 T on the target, whose center is at $z = 0$.

The second magnet module, also shown in Fig. 4, contains 5 superconducting coils with a total length of 5 m, and is separated from the first module by a gap of 2 m that permits the high field on the target to drop off quickly with

z . The currents in the coils of the second module are chosen such that the axial field drops to 2 T at $z = 5$ m, and remains at this value for larger z .

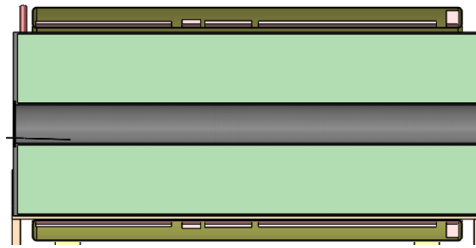

Figure 5: Section of the second magnet module, which completes the taper from 20 to 2 T.

Maps of the magnetic field generated by the first two magnet modules are shown in Figs. 6-7. The fringe field from the 20-T solenoids is still 1 T at $z = -5$ m, where the last Final Focus quadrupole might be located. Shielding of this quadrupole from the 1-T field by iron plates seems impractical, such that the quadrupole may need to be superconducting. In that case, it must be protected against radiation damage from backward-going secondary particles from the target.

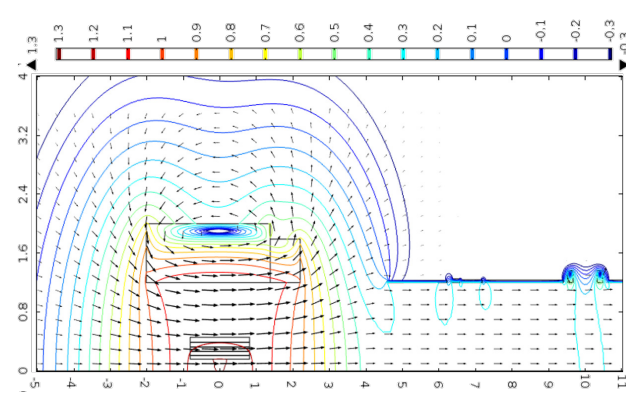

Figure 6: Field map of the taper region for $0 < r < 4$ m and $-5 < z < 11$ m.

To protect the superconducting coils in the Target System magnet modules from radiation damage, cylinders that contain tungsten beads (cooled by He-gas flow) are inserted inside them, but outside the beam tube, as shown in Figs 3-5. These shields have typical masses of 100 tons, such that there are significant issues as to their support (especially during assembly). It may be that the magnet modules will be reduced in length to 2.5 m each in future designs to improve their ease of handling.

The mechanical forces between magnet modules are substantial, and must be counteracted by room-temperature standoffs (not shown).

The third magnet module, also shown in Fig. 8, contains 6 superconducting coils with a total length of 5 m, and maintains a constant axial field of 2 T along its length. This module could be replicated throughout the straight

Content from this work may be used under the terms of the CC BY 3.0 licence (© 2014). Any distribution of this work must maintain attribution to the author(s), title of the work, publisher, and DOI.

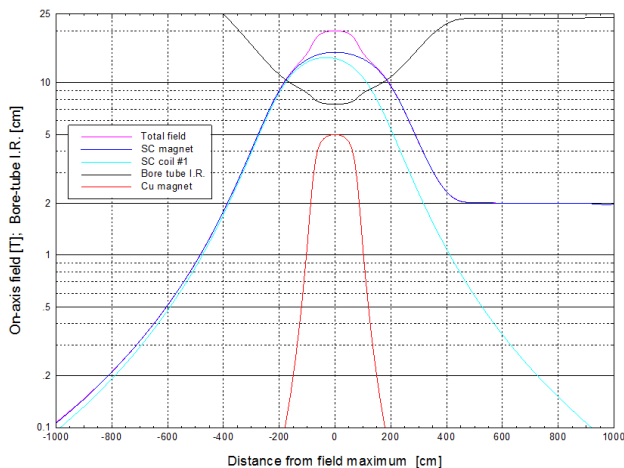

Figure 7: Axial magnetic field for $-10 < z < 10$ m.

sections of the Front End Decay Channel. To permit gaps between magnet modules for services and mechanical supports while maintaining a uniform field in the gap, the first and last coils in this module have higher currents than the central four.

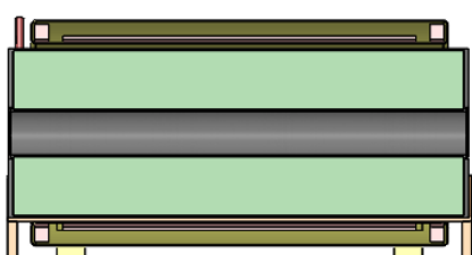

Figure 8: Section of the standard magnet module of the Decay Channel.

CHICANE MAGNETS

The solenoid magnet system not only transports the desired muons, but also scattered protons of energies up to that of the incident beam. Nearly 10% of the incident beam power is transferred to these protons, which eventually would strike the rf components of the Buncher and Phase Rotator. To mitigate this, a Chicane in the Decay Channel magnet system in the form of a bent solenoid is foreseen [16], as illustrated in Figs. 9-10. Of course, the Chicane coils must contain internal shielding to absorb the high-energy protons as they are deflected out of the beam.

A proton absorber (≈ 10 cm of Be) follows the Chicane to absorb remaining soft protons in the beam.

REFERENCES

- [1] D. Neuffer, Colliding Muon Beams at 90 GeV, Fermilab-FN-319 (1979).
- [2] R. Palmer *et al.*, $\mu^+ - \mu^-$ Collider, a Feasibility Study, BNL-52503 (1996).

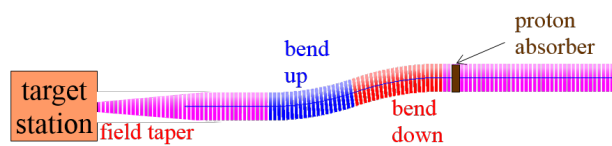

Figure 9: Sketch of the chicane concept to deflect high-energy protons out of the muon beam.

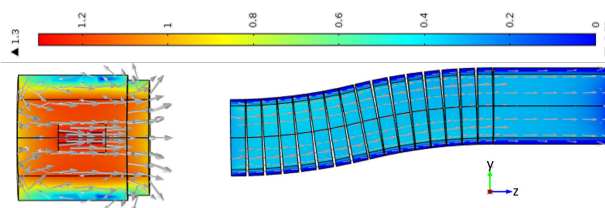

Figure 10: The Chicane magnets form a bent solenoid.

- [3] M.M. Alsharo'a *et al.*, Recent progress in neutrino factory and muon collider research within the Muon Collaboration, Phys. Rev. ST Accel. Beams **6**, 081001 (2003).
- [4] S. Geer, Neutrino beams from muon storage rings: Characteristics and physics potential, Phys. Rev. D **57**, 6989 (1998).
- [5] J.S. Berg *et al.*, Cost-effective design for a neutrino factory, Phys. Rev. ST Accel. Beams **9**, 011001 (2006).
- [6] R.J. Abrams *et al.*, IDS-NF Interim Design Report, <http://arxiv.org/abs/1112.2853>
- [7] H.K. Sayed *et al.*, Optimizing Muon Capture and Transport for a Neutrino Factory/Muon Collider Front End, IPAC13, THPFI075.
- [8] K.T. McDonald *et al.*, Target System Concept for a Muon Collider/Neutrino Factory, Proc. IPAC14, TUPRI008.
- [9] X. Ding, H.G. Kirk and K.T. McDonald, Optimization of Particle Production for a Muon Collider/Neutrino Factory with a 6.75 GeV Proton Driver, Proc. IPAC14, THPRI089.
- [10] H. Tsuji *et al.*, ITER R&D: Magnets: Conductor and Joint Development, Fus. Eng. Des. **55**, 141 (2001).
- [11] K.H. Tanaka *et al.*, Development of Radiation Resistant Magnets for JHJ/J-PARC, IEEE Trans. Appl. Supercon. **14**, 402 (2004).
- [12] J.H. Schultz, Radiation Resistance of Fusion Magnet Materials, IEEE Fusion En. **423** (2003).
- [13] N. Souchlas *et al.*, Energy Flow and Deposition in a 4-MW Muon-Collider Target System, Proc. IPAC12, WEPPD036.
- [14] R.J. Weggel *et al.*, Shielding of Superconducting Coils for a 4-MW Muon-Collider Target System, Proc. IPAC12, WEPPD037.
- [15] <http://www.hep.princeton.edu/~mcdonald/mumu/target/weggel/20to2T5m120cm4pDL.xlsx>
- [16] C.T. Rogers *et al.*, Muon front end for the neutrino factory, Phys. Rev. ST Accel. Beams **16**, 040104 (2013).