

# A CONTROL SYSTEM FOR THE FRANZ ACCELERATOR

Suha Alzubaidi<sup>#</sup>, O. Meusel, U. Ratzinger, K. Volk, C. Wagner,  
 IAP, Frankfurt am Main, Germany  
 H. Dinter, DESY, Hamburg, Germany

Content from this work may be used under the terms of the CC BY 3.0 licence (© 2014). Any distribution of this work must maintain attribution to the author(s), title of the work, publisher, and DOI.

## Abstract

The Frankfurt Neutron Source at the Stern- Gerlach Zentrum (FRANZ) is a multi-purpose facility for experiments related to accelerator development and nuclear astrophysics. A 200 mA proton beam will produce a neutron flux by use of the reaction  ${}^7\text{Li}(p,n){}^7\text{Be}$ . To study the reliability and performance of the accelerator an effective and powerful control system will be needed. A small ion source was used for the first performance test of the control system. The design of the control loop algorithm for the High Current proton source will be discussed. Physical data routinely taken by the control system are compared with manual measurements.

## INTRODUCTION

The control system discussed here covers all components of the FRANZ facility. On the one hand it controls the operation status of each component permanently, on the other hand it delivers data relevant for service and personal security maintenance. This system deals with all non- time- critical tasks of FRANZ while there will be rf control systems and fast control loops separately

The main parts of FRANZ are shown in Fig. 1 [1]. A volume type ion source delivering proton currents of 200mA and 120 keV of energy, followed by a low energy beam transport (LEBT) which consists of four solenoids and a magnetic chopper for producing beam pulses of 100 ns with a repetition rate up to 250 kHz. The main acceleration of the proton beam will be provided by a radio frequency quadrupole (RFQ) working at 175 MHz with an output energy of 700 keV and a subsequent Interdigital- H-type drift tube linac (IH-DTL) for achieving a variable output energy from 1.9 to 2.2 MeV. At the end a Mobley type bunch compressor will merge 9 micro bunches to a 1 ns beam pulse. The total length of the overall facility is about 10 m [2].

## FRANZ CONTROL SYSTEM

The main purpose of the control system is to send tasks and commands from the computers to the end devices and to receive and read out messages sent back.

The FRANZ control system consists of two basic layouts; the high level control and the data acquisition through the Ethernet layout, and the low level layout for interlock and security system like emergency shutdown (see Fig. 2). A TCP/IP Ethernet is used as physical

communication backbone. All the devices will be connected to the Ethernet. To prevent software induced device outage, the number of computers will be as low as possible.

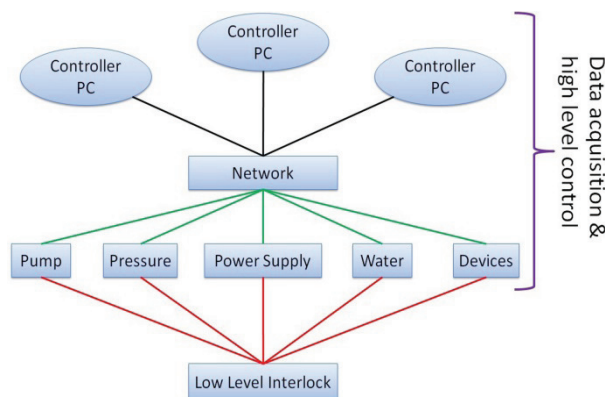

Figure 2: Layout levels of FRANZ control system.

Three types of communication are used in FRANZ control system:- devices directly connected to the network (if possible) - connected through a converter in case of having a common interface like RS232- connected through a computer in case of using an interface like USB. The network topology for FRANZ is shown in Fig. 3 1Gbe links are used between devices and computers. Redundant links are used to maintain network operation during network link or switch failures.

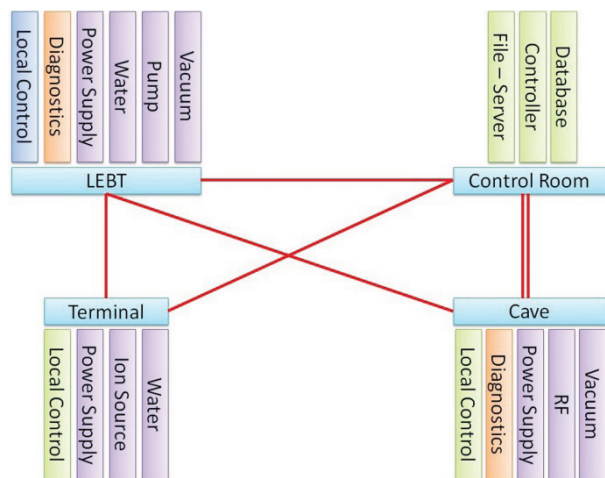

Figure 3: Network topology for FRANZ.

<sup>#</sup>s.alzubaidi@iap.uni-frankfurt.de

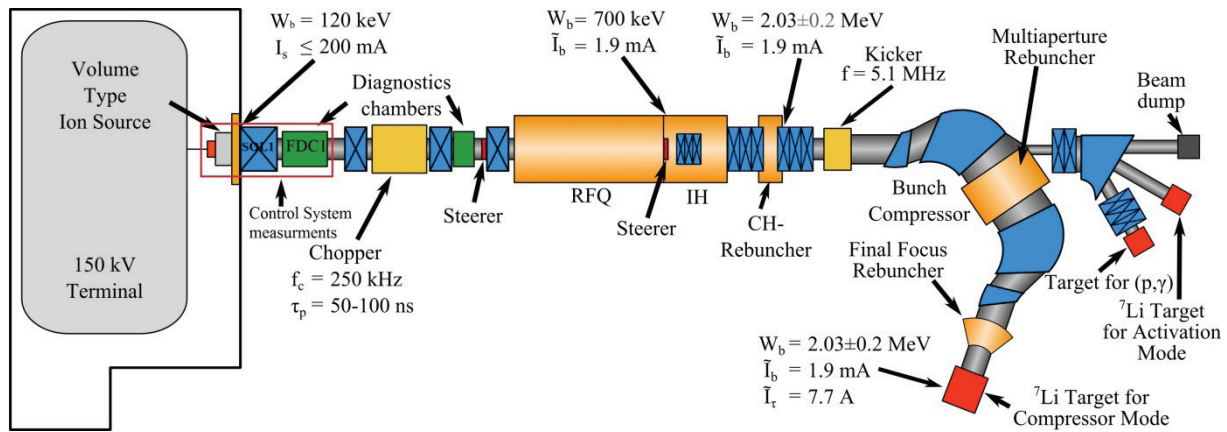

Figure 1: Schematic layout of Frankfurter Neutron Source at Stern-Gerlach-Zentrum.

A Mesh Networked Data Acquisition and Control System (MNDACS) is used as control system for FRANZ [3]. It is a Java based control system. The program layout is shown in Fig. 4. It consists of a kernel which manages all device drivers, graphical user interface (GUI) and driver abstraction layer (DAL), which provided to get access to devices with local drivers or drivers loaded at different computers.

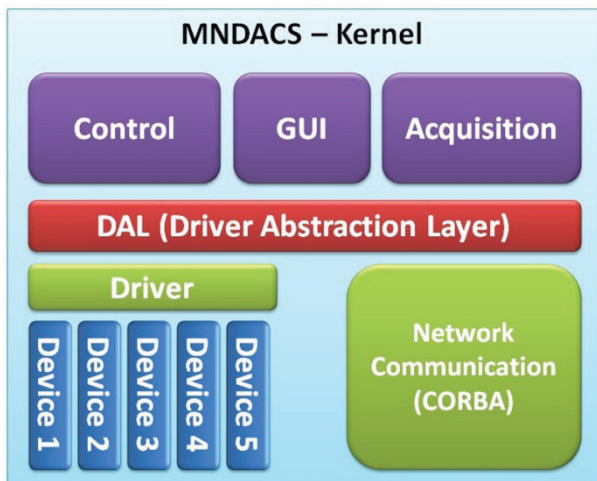

Figure 4: Program architecture of MNDACS.

## MEASUREMENTS OF ION SOURCE AND LEBT

As a first test of the control system with respect to the data acquisition and measurements, a test volume type ion source with a pentode extraction system and the low energy beam transport (LEBT) were used. The LEBT is located downstream the ion source and it has four magnetic solenoids for beam focusing and matching.

After launching the setup for ion source, LEBT and terminal, the beam current was measured with respect to the first solenoid magnetic field by a Faraday cup, which is located after the first solenoid. Results provided by the control system were compared with manually taken measurements. Fig. 5 shows the conventional measurements vs. automatized measurements for the beam current at different beam energy vs magnetic field. There

is a fluctuation between these two curves because of the resolution of the control system, which is adjusted to read the data every minute once, and a slight fluctuation of the ion source.

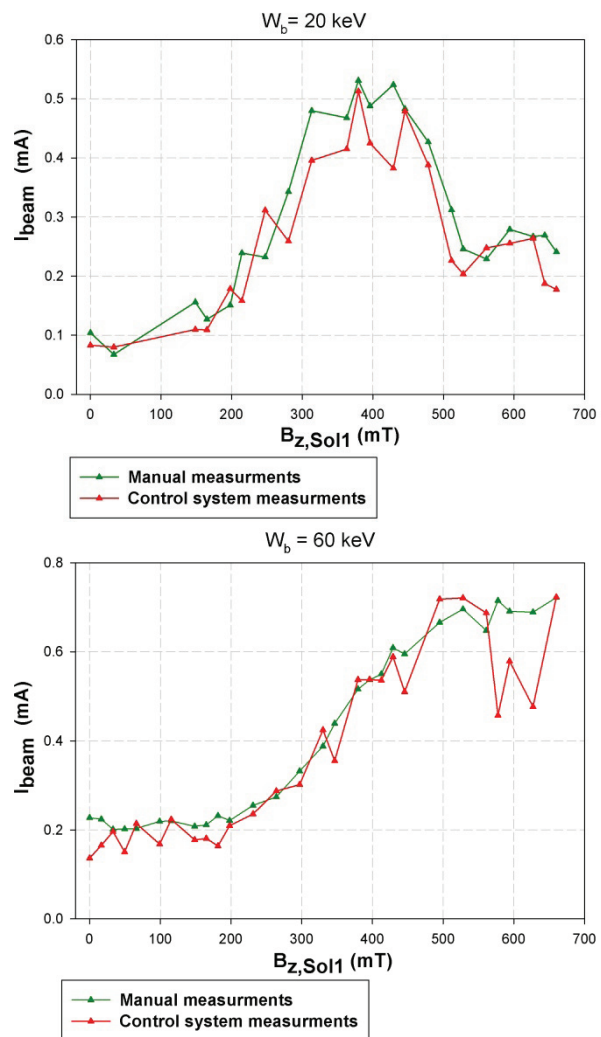

Figure 5: Comparison between two methods of measuring beam current for two different beam energies 20 keV (top) and 60 keV (bottom).

Content from this work may be used under the terms of the CC BY 3.0 licence (© 2014). Any distribution of this work must maintain attribution to the author(s), title of the work, publisher, and DOI.

Measurements of a wide parameter space can be done easily by the use of the control system. Fig. 6 shows a heat map of beam current as a function of magnetic field  $B_z$  vs. the beam energy  $W_b$ .

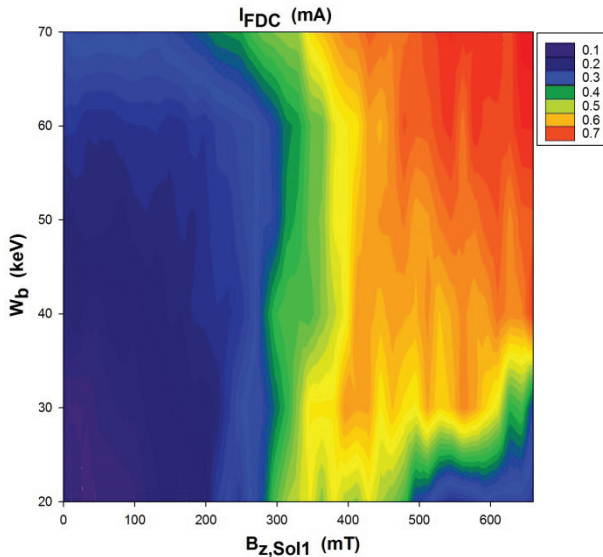

Figure 6: Heat map of beam current measured by a Faraday cup as a function of  $B_z$  and  $W_b$  (data taken by the control system).

These measurements are well suited for an evaluation of the performance of the accelerator components.

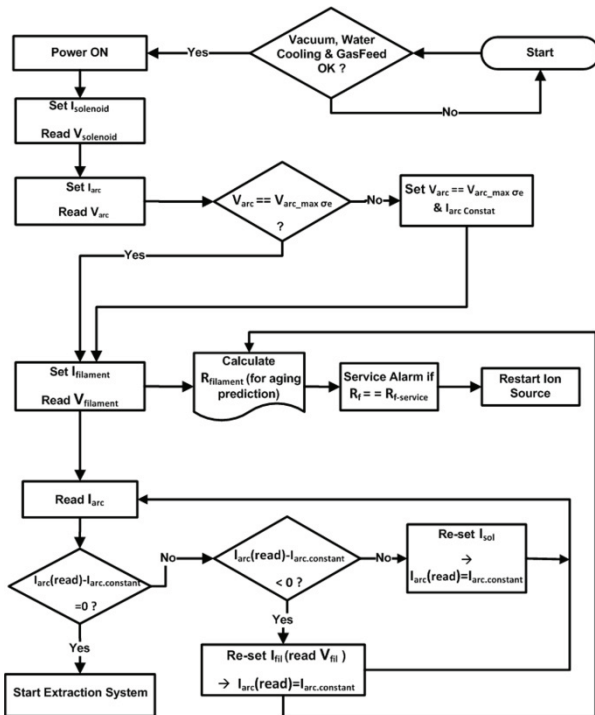

Figure 7: Plasma generator proposed control loop.

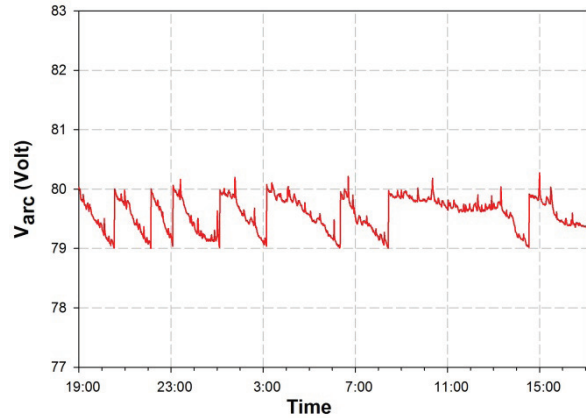

Figure 8: Arc voltage measurements records by control system.

The control system of the ion source is an example of a single component of a much larger system (FRANZ). The ion source has two main parts to be controlled; the plasma generator and the extraction system. The plasma generator control loop is included in control system already to keep the arc voltage in a constant interval of  $[79\text{ V} \leq V_{arc} \leq 80\text{ V}]$  by changing the filament heat current. Fig. 7 shows the control loop for the plasma generator and Fig. 8 shows the measured arc voltage data after including this loop in the control system.

## CONCLUSION AND OUTLOOKS

The FRANZ control system is based on the Java programming language because of the scalable security features. The GUI for FRANZ provides easy and fast data presentation for users. If the resolution of the control system will be flexible, then the difference between manually taken data and measured data will be less. This means to create a measurement mode where the read out time can be chosen. The control algorithm will be extended and tested to the other components.

## REFERENCES

- [1] U. Ratzinger et al., "The Frankfurt Neutron Source FRANZ", Proceeding of IPAC'10, Kyoto, Japan, MOPEC059, pp. 597-599 (2010).
- [2] O. Meusel et al., "Proton LINAC for Frankfurt Neutron Source FRANZ", Proceeding of International Topical Meeting on Nuclear Research Applications and Utilization of Accelerators, 4-8 May 2009, Vienna, AT/RD-07.
- [3] sourceforge.net website:  
<http://sourceforge.net/projects/mndacs>