

# PROGRESS ON THE DIPOLE MAGNET FOR A RAPID CYCLING SYNCHROTRON\*

H. Witte<sup>†</sup>, J. S. Berg, Brookhaven National Laboratory, Upton, NY, USA  
 M. L. Lopes, Fermilab, Batavia, IL, USA

## Abstract

A rapid cycling hybrid synchrotron has been proposed for the acceleration of muons from 375 to 750 GeV. The bending in a hybrid synchrotron is created with interleaved cold and warm dipoles; the warm dipoles modulate the average bending field for the different particle momenta.

A key challenge for the warm dipole magnets is the ramp rate, which is equivalent to frequencies of 400–1000 Hz. Recently a design has been suggested which employs 6.5% Si steel for the return yoke and FeCo for the poles. In simulations the design has shown a good performance (up to 2T) due to the FeCo and acceptable power losses by employing SiFe with a high Si content.

The paper discusses the effect of eddy currents induced in the laminations and hysteresis effects on the field quality.

## INTRODUCTION

A hybrid synchrotron interleaves superconducting dipoles with bipolar pulsed dipoles to rapidly vary the average bending field as particles accelerate while keeping that average bending field high. This is the most efficient way known to accelerate muons to multi-TeV energies. The short muon lifetime requires pulse periods below 1 ms for the dipoles. The design of one hybrid synchrotron stage is described in more detail in [1]; in [2] a general magnet design for the warm dipoles is discussed. This magnet design employs two different materials to optimize the core losses while achieving a very high peak magnetic field. In this paper we focus on the effect of the hysteresis and eddy currents in the laminations on the field quality. Fig. 1 shows an overview of the magnet geometry.

## COMPUTER SIMULATIONS

### Hysteresis

To study hysteresis effects we employ the Jiles-Atherton model [3]. The following equations are introduced in a 2D planar transient finite element simulation (COMSOL Multiphysics<sup>1</sup>):

$$\frac{dM}{dH} = (1 - c)\delta \frac{L(H + \alpha M) - M}{k(1 - c) \operatorname{sgn}(\dot{H}) - \alpha (L(H + 2M) - M)} \quad (1)$$

with

$$L(H) = M_{\text{sat}} \left[ \coth \left( \frac{H}{a} - \frac{a}{H} \right) \right] \quad (2)$$

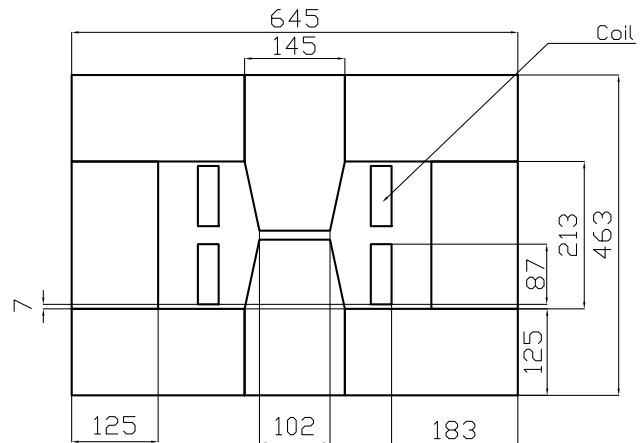

Figure 1: Geometry of the dipole magnet (in mm).

and

$$\delta = \begin{cases} 0 & \text{for } \dot{H} (L(H + \alpha M)) \leq 0 \\ 1 & \text{otherwise} \end{cases} \quad (3)$$

In these equations  $M$  is the magnetization and  $H$  the magnetic field strength. The Jiles-Atherton model employs five parameters to describe the hysteresis loop of a particular material:  $M_{\text{Sat}}$  is the saturation magnetization and  $a$  is a coefficient which can be interpreted as a measure of the coupling between the adjoining magnetic domains.  $k$  can be related to pinning site density and  $\alpha$  is a parameter which is a measure of internal feedback.  $c$  is a further model parameter.

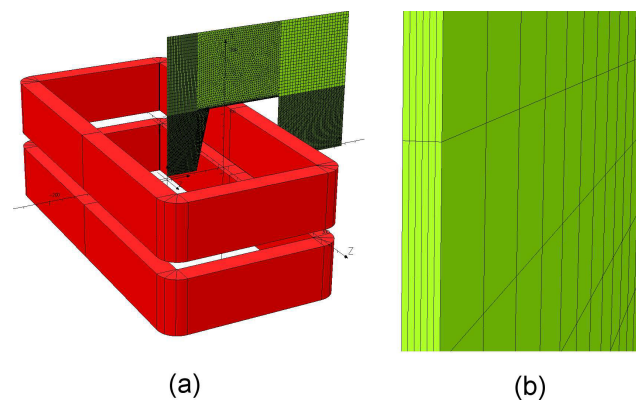

Figure 2: Mesh of the 3D finite element model.

The simulation employs a transient solver with a time step of about  $8\mu\text{s}$  to improve convergence.

### Eddy Currents

The eddy currents in the yoke of the dipole magnet are evaluated in a 3D time-harmonic simulation using

Content from this work may be used under the terms of the CC BY 3.0 licence (© 2014). Any distribution of this work must maintain attribution to the author(s), title of the work, publisher, and DOI.

\* Work supported by Brookhaven Science Associates, LLC under Contract No. DE-AC02-98CH10886 with the U.S. Department of Energy.

<sup>†</sup> hwitte@bnl.gov

<sup>1</sup> COMSOL AB, Tegnérgatan 23, SE-111 40 Stockholm, Sweden

ELEKTRA/Opera 3D<sup>2</sup>. The geometry consists of a single lamination; boundary conditions are used to exploit symmetry in longitudinal direction. The plane in the centre of the model (in longitudinal direction) is set to electrical insulation.

Of particular importance is the mesh in this simulation; we employ prism elements to keep the number of elements reasonable. In longitudinal direction the model consists of six layers of elements as shown in Fig. 2 (b).

For FeCo we use an electrical conductivity of 2.5 MS/m; for 6.5% SiFe the conductivity is 1.22 MS/m. We investigate the eddy currents at frequencies of 1, 50, 400 and 1000 Hz.

## EXPERIMENTAL DATA

Sheet samples of FeCo (Vacoflux 48 from Vacuum-schmelze<sup>3</sup>) and 10JNEX900 from JFE<sup>4</sup> were obtained and measured in an Epstein frame in combination with a Hysteresigraph 5500. The Jiles-Atherton model was fitted to the obtained data using a Python script in an iterative manner until a good agreement was achieved. The measured data and the fit are shown in Fig. 3 for FeCo and in Fig. 4 for SiFe.

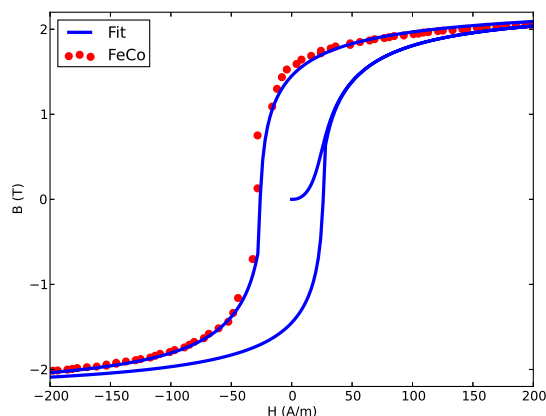

Figure 3: Measured hysteresis curve of FeCo. The figure also shows the result of the fit to the Jiles Atherton parameters.

Table 1: Jiles-Atherton Parameters

	FeCo	6.5%SiFe
a	31	2.5
c	0.01	0.0001
k	27	22
M <sub>sat</sub>	1850000	960000
$\alpha$	$5 \times 10^{-5}$	$2.04 \times 10^{-5}$

<sup>2</sup> Vector Fields Simulation Software, Kidlington, UK

<sup>3</sup> VACUUMSCHMELZE GmbH & Co. KG, Grüner Weg 37, D-63450 Hanau, Germany

<sup>4</sup> JFE Steel Corporation, Electrical Steel Section, Tokyo, Japan

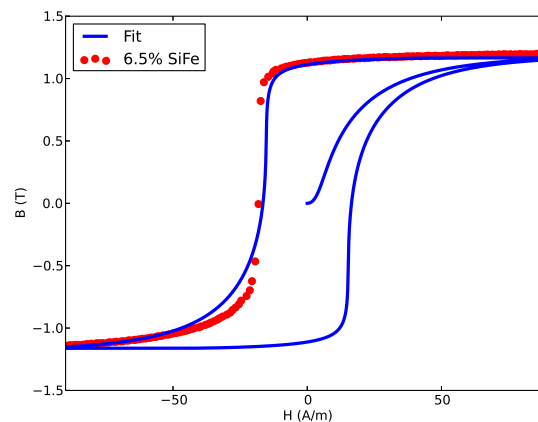

Figure 4: Measured hysteresis curve of 6.5% SiFe. The figure also shows the result of the fit to the Jiles Atherton parameters.

Table 1 summarizes the Jiles-Atherton parameters for both FeCo and 6.5% SiFe.

## SIMULATION RESULTS

Figure 5 shows the hysteresis loops for both materials at two different positions in the model, which are (0/25mm) for FeCo and (-0.25mm/0) for 6.5% SiFe. The figure shows that the model interprets the hysteresis data correctly.

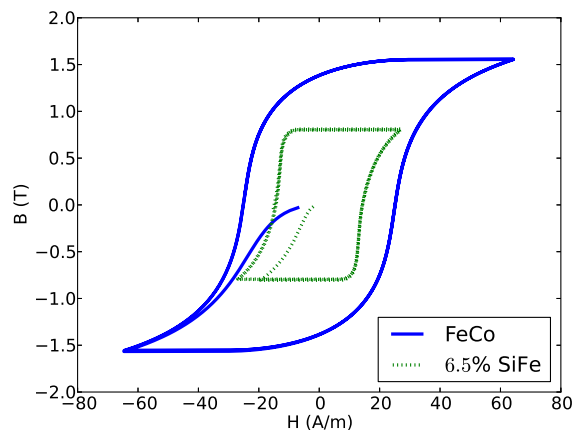

Figure 5: Hysteresis loops of FeCo and SiFe at two different positions in the model.

Figure 6 shows the effect of the hysteresis on the field quality (centre plane of the magnet,  $\pm 30$ mm). The figure shows that the effect of the hysteresis on the field quality is of the order of  $5 \times 10^{-4}$ . This is not prohibitive, but approaches the required minimum field quality of  $1 \times 10^{-3}$  for this magnet.

Due to the hysteresis the magnetic field is shifted in time with respect to the excitation current, which is shown in Fig. 7. The figure compares the field in the centre of the magnet with a pure sinusoidal function; as shown, the hysteresis shifts the magnetic field by about 10  $\mu$ s.

Any distribution of this work must maintain attribution to the author(s), title of the work, publisher, and DOI.

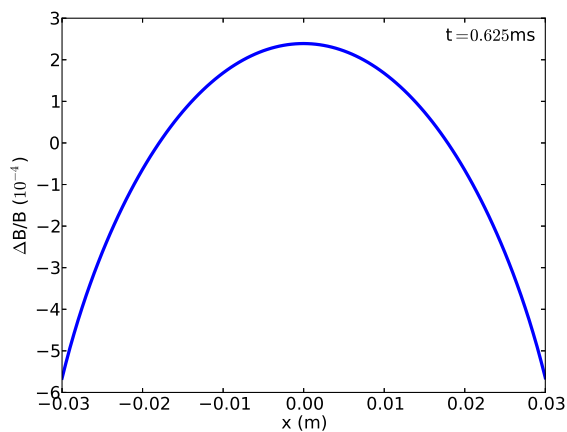

Figure 6: Field quality on the centre plane at peak field ( $B=1.5T$ ).

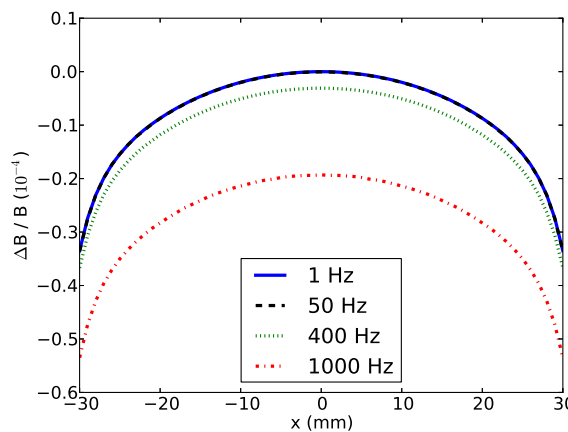

Figure 8: Field uniformity in the mid plane due to the eddy current losses as function of the frequency.

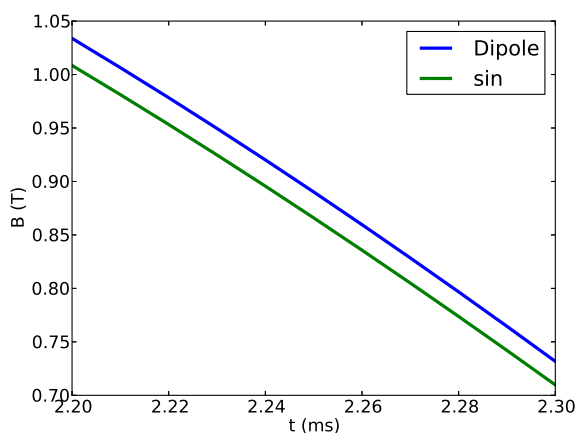

Figure 7: Magnetic field in centre of magnet in comparison to a pure sinusoidal function.

The result of the eddy current simulations are shown in Fig. 8. The figure shows the field quality  $\Delta B/B_0$  on the centre plane across the region of interest ( $\pm 30$  mm) for different frequencies at 1.5T. As shown, the results at 1 Hz and 50 Hz are identical, which indicates no significant effect of eddy currents. At 400 Hz a small change of  $0.5 \times 10^{-5}$  can be observed. At 1000 Hz the field quality changes by  $2 \times 10^{-5}$ . The maximum observed attenuation of the field in the gap due to the eddy currents was 2 mT.

## CONCLUSION

In this paper we investigated the impact of hysteresis effects and eddy currents on the field quality of a dipole magnet for a hybrid synchrotron. The magnet employs FeCo for the pole and 6.5%SiFe for the rest of the yoke.

The analysis shows that both have an effect on the field quality. The impact of hysteresis effects on the field quality is on the order of  $5 \times 10^{-4}$  for a field of 1.5T. The effect of eddy currents is about one order of magnitude smaller; this applies to laminations with a thickness of 100  $\mu\text{m}$  and frequencies of 1 kHz or less.

Both eddy currents and hysteresis affect the field quality to less than  $1 \times 10^{-3}$ , which is the required minimum field quality.

Hysteresis effects also lead to a shift of the magnetic field with respect to the excitation current by about 10  $\mu\text{s}$ . This time shift needs to be considered for accelerator operation.

## ACKNOWLEDGMENT

We gratefully acknowledge the help of Robert W Riley and John R Zweibohmer (Technical Division, Fermilab) for measuring the magnetization curves necessary for this work. We would also like to thank Chris Riley from VectorFields (UK) for his help with the eddy current simulation. We appreciate the help of COMSOL support for modeling hysteresis effects.

## REFERENCES

- [1] J. S. Berg and A. A. Garren. Hybrid Fast-Ramping Accelerator to 750 GeV/c: Refinement and Parameters over Full Energy Range. Technical Report BNL-98171-2012-IR, MAP-doc-4335, BNL, 2012.
- [2] H. Witte, J. Berg, M. Anerella, P. Kovach, and M. L. Lopes. Rapid Cycling Dipole Magnet. In *Proc. of NA-PAC13*, pages 1–3, 2013.
- [3] D. C. Jiles and D. L. Atherton. Theory of ferromagnetic hysteresis (invited). *Journal of Applied Physics*, 55(6):2115.