

# BACKSCATTERING X-RAY SYSTEM BY USING 950 keV X-BAND LINAC X-RAY SOURCE

C. Liu<sup>#</sup>, M. Uesaka, T. Fujiwara, K. Dobashi, The University of Tokyo, Japan  
J. Kusano, Accuthera Inc., Kawasaki, Japan

## Abstract

Recently several tunnel collapses have happened in the world. To prevent this kind of accidents, the non-destructive inspection for tunnel is seriously needed. Backscattering X-ray system which makes one-side operation possible is a very important way to solve this problem. But the backscattering X-ray systems using X-ray tubes could only get the superficial information of the concrete target [1]. Now we are using our 950 keV X-ray source to construct the backscattering X-ray system to detect the deeper part of the concrete target.

## INTRODUCTION

BS (backscattering) X-ray system is based on the Compton scattering of X-rays. Compton scattering is an inelastic scattering of X-ray photon by the outer shell electrons. In BS X-ray system, the X-rays are collimated into a pencil beam and scan across the target in a motion profile appropriate for covering the area of interest. When the X-rays illuminate the object, some of the X-rays will be backscattered and detected by the detectors. Then we could detect the intensity of the backscattering X-ray of each point and get the image of the target. Figure 1 shows the application of BS X-ray system for tunnel inspection which we plan to construct.

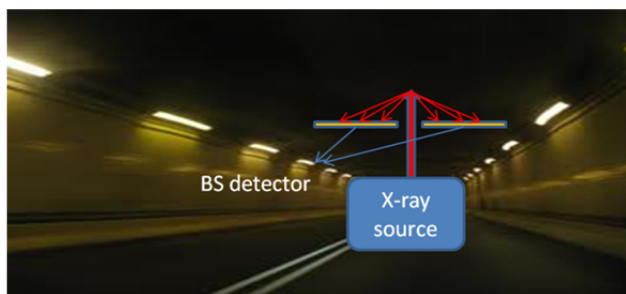

Figure 1: BS X-ray system for tunnel inspection.

Comparing with the transmission X-ray system [2,3], the backscattering X-ray system has two important advantages. Firstly, based on the principle of Compton scattering, the backscattering X-ray will highlight the materials with smaller atom numbers which could help us know the inner structure of the target more clearly. Besides, in the backscattering X-ray system the X-ray source and detector will be positioned on the same side of the target. In many cases it is difficult or impractical to put the detector at the other side of the subject so only backscattering X-ray system could be used.

So far, X-ray tubes, such as 225 kV X-ray tube, 300 kV X-ray tube, have been used to construct the backscattering

X-ray system for the inspection of concrete. By using this kind of X-ray tubes we could only get the information from superficial part of concrete [1]. If we want to detect the deeper part, X-ray source with higher energy is needed. As we have 950 keV compact X-band linac X-ray source shown in Fig. 2, we are using this X-ray source to construct the system.

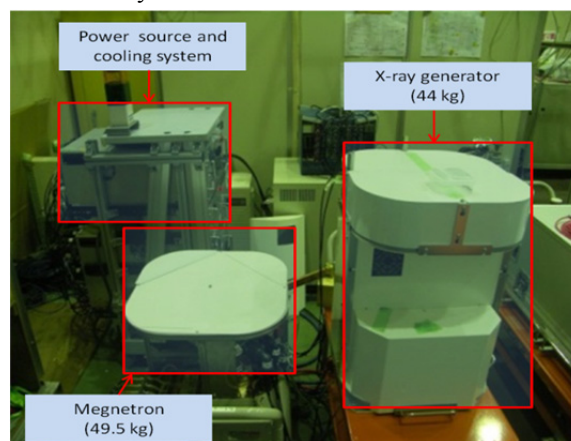

Figure 2: 950 keV X-band linac X-ray source.

## NUMERICAL ANALYSIS

To investigate several problems such as the relationship between the detectable depth and energy of the X-ray and the energy spectrum of the backscattering X-ray, we have used the EGS 5 code system to do the Monte Carlo simulation of it.

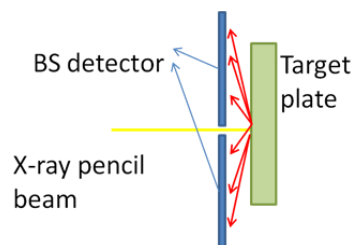

Figure 3: Simulation model.

The simulation model is shown in Fig. 3. We set a target plate and detector. The X-ray pencil beam hit the target plate and the backscattering photons will be generated and detected by the detector. The energy of the X-ray, material of the target and thickness of the target could be changed.

Figure 4 shows the relationship between the detectable depth and the energy of the monochromatic X-rays. From the result we could see that when the energy of the X-ray

Content from this work may be used under the terms of the CC BY 3.0 licence (© 2014). Any distribution of this work must maintain attribution to the author(s), title of the work, publisher, and DOI.

is lower than 300 keV, the Backscattering photon rate and the detectable depth increases as the energy of X-ray increases. And when the energy of X-ray is higher than 300 keV, the backscattering photon rate decreases as the energy of X-ray increase and the detectable depth will not increase.

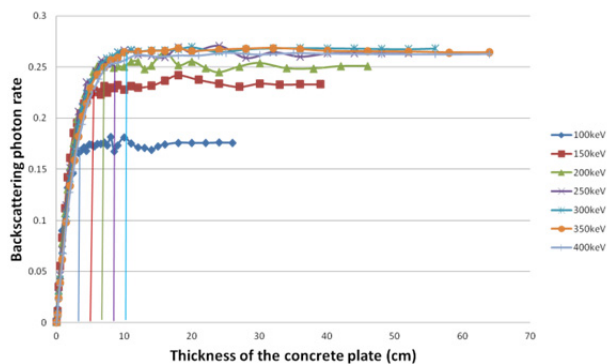

Figure 4: Simulation result about the relationship between the detectable depth and energy of monochromatic X-ray. As the thickness of the concrete plate increase, the total backscattering photon rate increases. If the backscattering photon rate increases to the peak and starts to fluctuate, it means we could not get the signal effectively from the part deeper than the peak depth. So the peak depth is the detectable depth.

Figure 5 shows the backscattering photon energy spectrum of monochromatic X-rays with different energy. As the result shows that the peak energy of the backscattering photons increases as the energy of monochromatic X-ray energy increases. Besides, as the energy of source X-ray increases, the range of the backscattering photon energy will become wider. Until the energy of source X-ray increase to 400 keV, the energy of backscattering photons will not be higher than 250 keV. This result could help us choose and design the detectors.

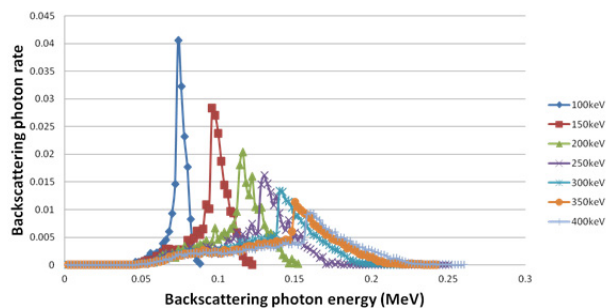

Figure 5: Simulation result of the backscattering photon energy spectrum of monochromatic X-rays with different energy for the 100cm concrete plate.

Figure 6 shows the output spectrum of our 950 keV X-band linac source. The result shows that large amounts of photons with the energy between 150 keV and 400 keV will be generated by our 950 keV X-ray source which are needed for the inspection for concrete target and as shown

in Fig. 7 by using our 950 keV X-ray source we could get the information from 10 cm depth.

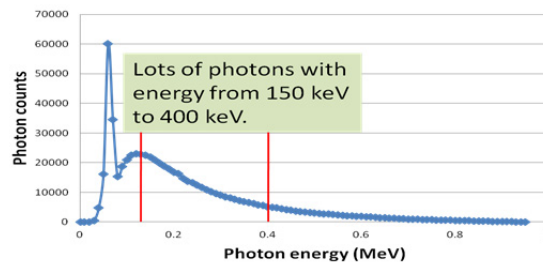

Figure 6: Output spectrum of 950 keV X-band linac X-ray source.

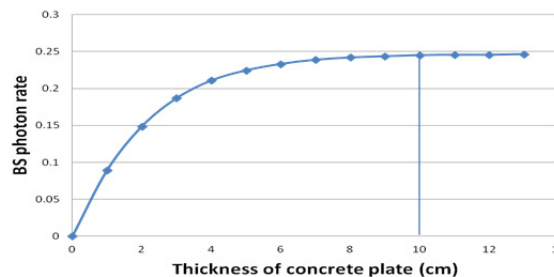

Figure 7: Detectable depth of 950 keV source.

## EXPERIMENTS

### Experiment by Using 950 keV X-ray Source

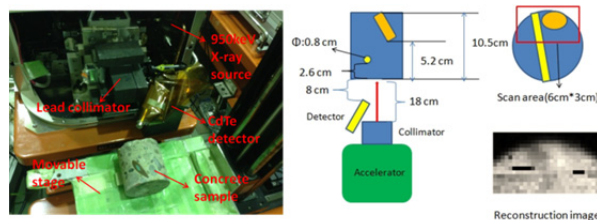

Figure 8: Experimental setup target and reconstruction image.

Figure 8 shows the experimental setup, the target sample and reconstruction image. From the reconstruction image we could see the iron rod at 2.6 cm depth and the iron part at 5.2 cm depth but we could not see the deeper part by using this experimental system.

There are several problems of this system. Firstly, many photons are backscattered at the superficial part of the concrete sample, we need some collimators to cut the noise from surface and only focus on the signals from deeper part. Besides, it is difficult to get a very stable output by using our 950 keV X-ray source and the detection efficiency for the photons with energy from 100 keV to 200 keV of CdTe detector is not very high. To increase the detection efficiency and cut the noise, new

detection system is needed. Figure 9 shows the detection system we have designed and are manufacturing now.

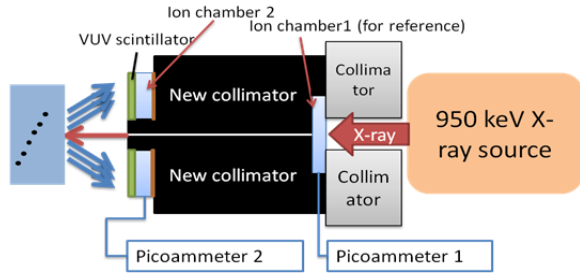

Figure 9: The detection system. We will use VUV scintillator which has high detection efficiency for the photons with energy from 100 keV to 200 keV. And we will use 2 ion chambers to comparing the intensity of backscattering X-ray and source X-ray to overcome the problem that the output is not stable.

### Experiment by Using 50 kV X-ray Tube

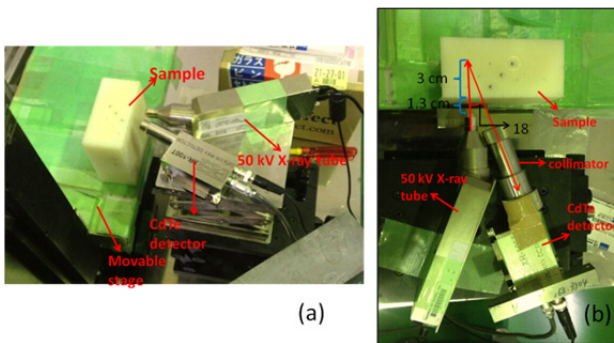

Figure 10: Normal experimental setup (a) and experimental setup with collimator for detector (b).

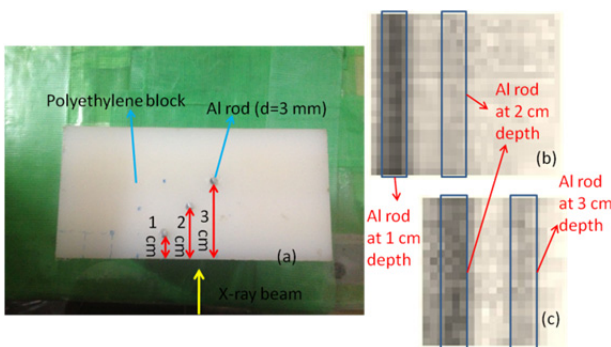

Figure 11: The inner structure of the sample (a), reconstruction image without using collimator (b) and reconstruction image using collimator (c).

Figure 10 shows the two kinds of experimental setups. We want to investigate whether this kind of collimator could help us cut the noise from the surface and detect the deeper part of the sample. The inner structure of the sample and the experimental result is shown in Fig. 11. From the result we could see that without using collimator for detector, we could only see the two Al rods

at 1 cm depth and 2 cm depth. But if we use the collimator for detector we could detect the Al rod at 3cm depth clearly.

### SUMMARY AND FUTURE WORK

From the simulation result we could know that the photons with energy from 150 keV to 400 keV is suitable for the inspection for concrete target. And by using our 950 keV X-band linac X-ray source we could get large amount of these photons which is difficult to get by using X-ray tubes. The basic experimental system has been constructed and we could see the iron at 5.2 cm depth in the concrete sample by using this system.

To cut down the noise from the superficial part, we are designing new collimator for the detector. Figure 12 shows the collimator for the detector.

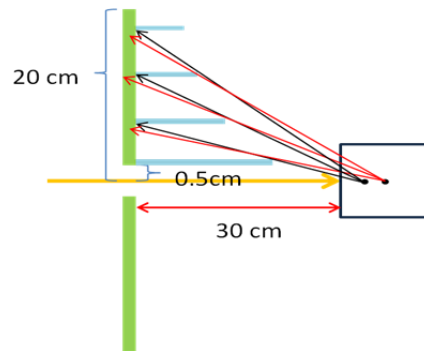

Figure 12: The collimator for detector. The blue plate is the collimator. We are design the collimator which could cut the photons backscattered at the depth less than 5cm and only let the signals from part deeper than 5cm enter the detector.

By now we have finished the design of the detection system and are manufacturing it. The experiment by using new detection system will start in July 2014. The design and manufacture of the collimator will be finished by the end of 2014. The experiment by using the collimator will start in January 2015.

### REFERENCES

- [1] D. Shedlok, T. Edwards, C.Toth, "X-ray Backscatter Imaging for Aerospace Applications", Review of Progress in Quantitative Nondestructive Evaluation, Volume 30 AIP Conf.Proc. 1335, 509-516 (2011).
- [2] W. Wu, H. Zhu et al., "Partial CT and Structural Analysis with 950 Kev/3.95 Mev X-Band Linac X-Ray Sources", E-Journal of Advanced Maintenance 5(2) (2013).
- [3] M. Uesaka, M. Jin et al., "Commissioning of portable 950 keV/3.95MeV X-band linac X-ray sources for on-site transmission testing", E-Journal of Advanced Maintenance 5(2) (2013).