

# THE COUPLING IMPEDANCE MEASUREMENT OF THE FAST EXTRACTION KICKER IN CSNS/RCS \*

Liangsheng Huang<sup>#</sup>, Yudong Liu, Sheng Wang, CSNS/IHEP, CAS, Dongguan, 523803, China

## Abstract

The Rapid Cycling Synchrotron of the China Spallation Neutron Source is a high intensity proton accelerator. In order to high intensity beam operation, the beam coupling impedance of the extracted kicker must be controlled. The measurement of longitudinal and transverse coupling impedance of the fast extraction kicker is described.

## INTRODUCTION

The electromagnetic interaction of a charged particle beam with its surroundings in the accelerator is conveniently described by the coupling impedances of its components. Coupling impedance and its instability budget are the important part of designing of a high intensity accelerator. Impedance measurement on the bench is a useful method to study the impedance [1] [2].

China Spallation Neutron Source (CSNS) is a high intensity proton accelerator based facility, which consists of an H- Linac, a Rapid Cycling Synchrotron (RCS) and two beam transport lines [3]. It accumulates and accelerate proton beam from 80 MeV to 1.6 GeV. The bunch length is range from 460 ns on injection to 80 ns on extraction. To achieve high beam current, the impedance must be carefully studied. The extraction kicker is the vital component devoted to the impedance. There are eight fast extraction kickers and the No. 2 kicker is measured. Figure 1 shows the kicker system. The main part of the kicker is the window-frame geometry ferrite with the material of CMD5005 [4]. The side strap connects the upper and lower busbar plates, and the busbar and the window-frame ferrite are located in a vacuum vessel, 0.58 m length. The power of the magnet comes from the PFN via the 130 m length cable. It is difficult to theoretically calculate the impedance for the complicated structure. Thus studying the impedance by measurement is a relevant method.

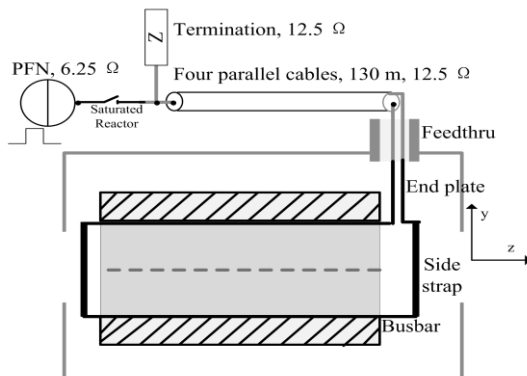

Figure 1: The extraction kicker system.

\* Supported by National Natural Science Foundation of China (11175193, 11275221)

<sup>#</sup> huangls@ihep.ac.cn

## MEASUREMENT METHOD

The assign of measurement is measure longitudinal and vertical impedance of the kicker system on range from 1 MHz to 100 MHz. Figure 2 shows the schematics of longitudinal impedance measurement with coaxial transmission line and transverse impedance measurement by the twin-wire and the loop method. The copper wire with 0.5 mm diameter is stretched in the Device Under Test (DUT) with the appropriate resistor for matching to the 50 Ω cables at both ends, and the matching resistor is mounted by 35 mm sucobox [5]. The Vector Network Analyzer (VNA, Agilent E5071C) is connected to measure the  $S_{21}$  and the input impedance. Four attenuators with 6 dB between the hybrid and the DUT are applied in the transverse impedance measurement by the twin-wire. The differential-mode signal in transverse measurement can be obtained by Hybrid ZFSCJ-2-1-N [6].

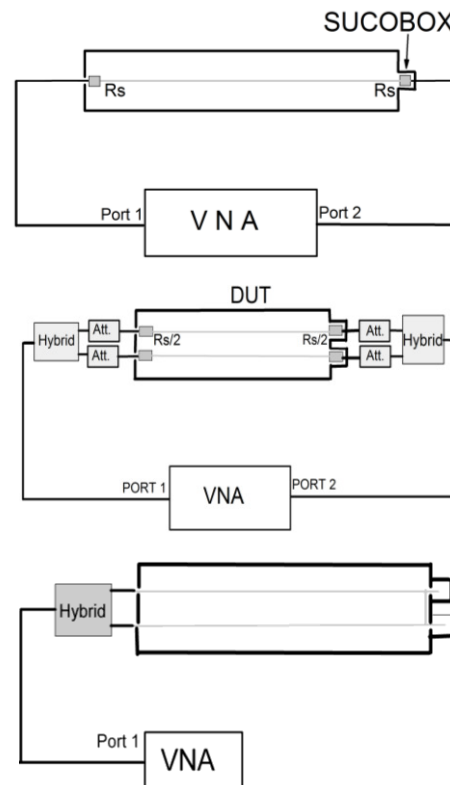

Figure 2: The schematics of longitudinal impedance measurement (coaxial transmission line, top) and transverse impedance measurement (twin-wire, middle and loop method, bottom).

The longitudinal and transverse coupling impedance in the measurement can be obtained as formulas

Content from this work may be used under the terms of the CC BY 3.0 licence (© 2015). Any distribution of this work must maintain attribution to the author(s), title of the work, publisher, and DOI.

$$\begin{aligned} Z_L &= -2R_c^L \ln(S_{21}^{DUT} / S_{21}^{REF}), \\ Z_T &= -2 \frac{c}{\omega \Delta^2} R_c^T \ln(S_{21}^{DUT} / S_{21}^{REF}), \\ Z_T &= \frac{c}{\omega} \frac{Z_{DUT} - Z_{REF}}{\Delta^2}. \end{aligned} \quad (1)$$

here,  $Z_L$  and  $Z_T$  are longitudinal and transverse impedance, respectively,  $R_c^L$  and  $R_c^T$  are characteristic impedance of the coaxial transmission line and the twin-wire method,  $S_{21}^{DUT}$  and  $S_{21}^{REF}$  are the scatter coefficient of the DUT and the REF,  $Z_{DUT}$  and  $Z_{REF}$  are input impedance in the loop measurement,  $c$  is speed of light,  $\omega$  is frequency, and  $\Delta$  is spacing of twin-wire.

### MEASUREMENT RESULT

The forward transmission coefficients for REF and the kicker with long cable, PFN and termination are measured. The longitudinal coupling impedance of kicker system is shown in Fig. 3. The peaks on about 30 MHz comes from the window ferrite. It is clear to see that an oscillation appears and the spacing of the oscillation is 0.72 MHz.

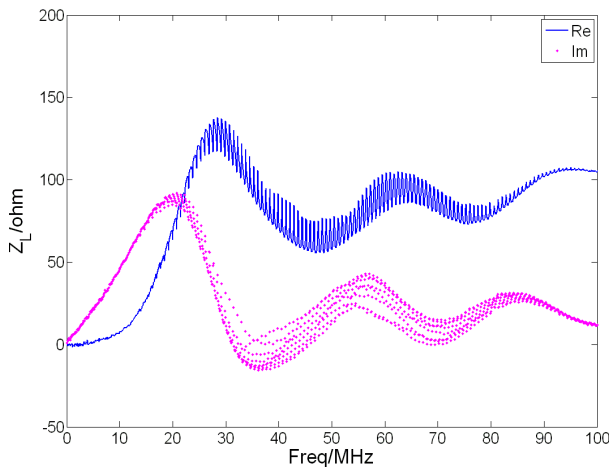

Figure 3: The longitudinal impedance of the kicker.

For transverse coupling impedance measurement, the twin-wire method is used. Due to big error below 10 MHz, it is shown from 10 MHz to 100 MHz. It is easy to see the vertical impedance is small. The loop is used to below 10 MHz, The vertical and horizontal impedances are shown in Fig. 5. The oscillation appears in vertical direction and its spacing is also 0.72 MHz. The oscillation from the mismatching of the long cable port can be expressed theoretically as

$$f_{start} = \frac{c}{4\alpha L}. \quad (2)$$

where,  $L$  is the long cable length, 130 m. the cable medium is polythene, and  $\alpha$  is refractive index of the

cable medium. The spacing in Eq. (2) is 0.72 MHz, which is consistent with the spacing in the measurement, so it is sure that the oscillation comes from mismatching of the port of the cable, PFN and termination.

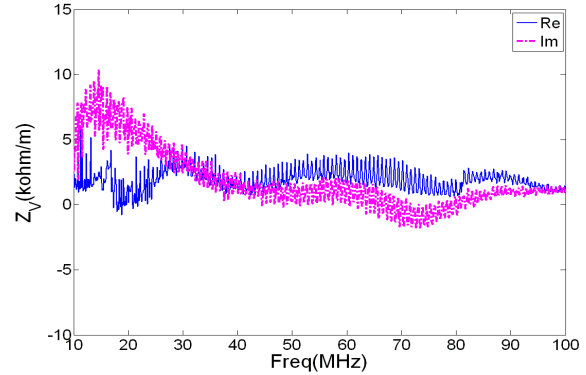

Figure 4: The measured vertical impedance of the extraction kicker by twin-wire.

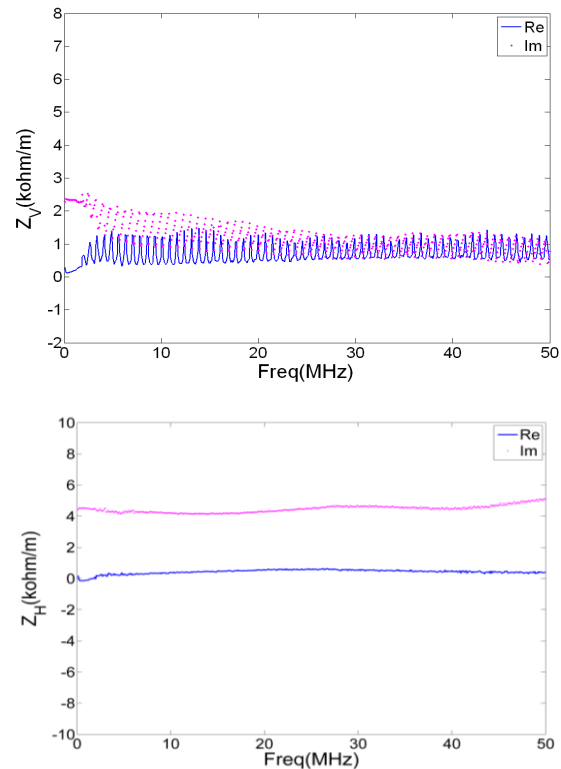

Figure 5: Transverse impedance of the kicker by loop.

For the oscillation, the ferrite absorbing ring with type of 8C12 [7] is used in the kicker to restrict it. At that time, the oscillations of the longitudinal and vertical impedance in Fig. 6 are also extremely decreased. Therefore, the ferrite ring is useful to absorb the reflection. Moreover, the inductance of the kicker system may increase and the rise time of the impulse of the kicker may be enhanced, so more experiment of the kicker and the power supply should be done before the ferrite ring is used practically.

Content from this work may be used under the terms of the CC BY 3.0 licence (© 2015). Any distribution of this work must maintain attribution to the author(s), title of the work, publisher, and DOI.

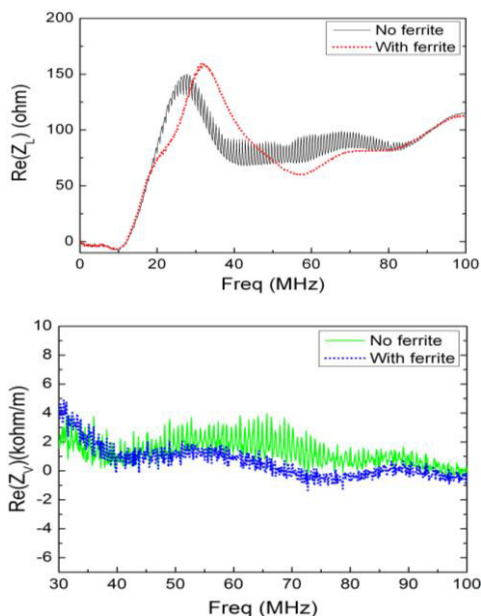

Figure 6: The impedance of the kicker system with and without the ferrite absorbing ring.

### THE IMPEDANCE OF EIGHT KICKERS

The structure of the eight kickers are similar, it is hardly to measure every kicker, so the scaling law is found to estimate the total impedance by CST simulation.

$$\begin{aligned} Z_{\parallel i} &= Z_{\parallel 2} \frac{S_2 L_i}{S_i L_2}, \\ Z_{\perp i} &= Z_{\perp 2} \frac{(h_2)^2}{(h_i)^2}. \end{aligned} \quad (3)$$

where,  $S_i$  is the area of inner surface of the window-frame geometry of the  $i^{\text{th}}$  kicker,  $L_i$  is the length of the window and  $h_i$  is height.  $Z_{\parallel i}$  and  $Z_{\perp i}$  are longitudinal and transverse impedance. According to the measurement of the No. 2 kicker, the total impedance of eight kickers are offered by the scaling law as shown in Fig. 7 and Fig. 8, and the total longitudinal, vertical and horizontal impedance are  $53+j45 \Omega$ ,  $5+j10 \text{ k}\Omega/\text{m}$  and  $3+j22 \text{ k}\Omega/\text{m}$ .

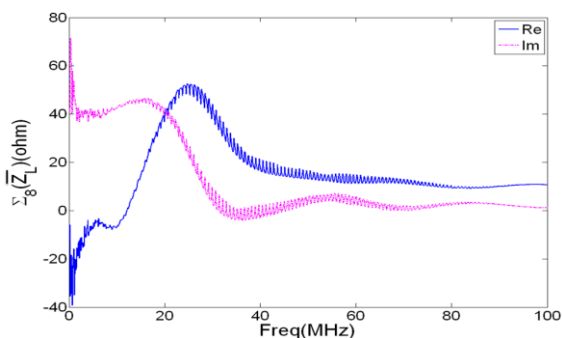

Figure 7: The total average longitudinal impedance of the eight kickers.

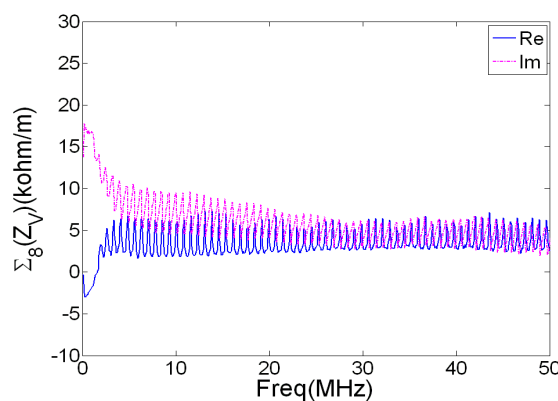

Figure 8: The vertical impedance of the eight kickers.

### CONCLUSION

The longitudinal and transverse impedance are measured on the bench. The oscillation from the mismatching of the long cable port affects longitudinal and vertical impedance, fortunately, the type of ferrite ring, 8C12, can restrict the reflection. According to the measurement, the total impedance of eight kickers are offered by the scaling law, and the total longitudinal, vertical and horizontal impedance are  $53+j45 \Omega$ ,  $5+j10 \text{ k}\Omega/\text{m}$  and  $3+j22 \text{ k}\Omega/\text{m}$ .

### ACKNOWLEDGEMENT

We would like to thanks prof. F. Caspers and Prof. Y. Irie for many discuss in the measurement. We also would like to acknowledge the support of many colleagues in the IHEP, especially, Dr R. H. Liu and O. Z. Xiao for many direction help in the experiment.

### REFERENCES

- [1] F. Casper, Bench methods for beam-coupling impedance measurement, Lecture Notes in Physics, 1992, Geneva.
- [2] H. Hahn and F. Pedersen, On Coaxial Wire Measurement of the Longitudinal Coupling Impedance, BNL 50870, 1978.
- [3] CSNS Design Report, IHEP-0107 (2011).
- [4] Kicker design report, IHEP-0119(2010).
- [5] <http://de.farnel.com/huber-suhner/fbb-cb-50-0-1-e/sucobox-prototy-box/dp/4162950>, 2013.12.
- [6] <http://www.minicircuits.com/homepage/homepage.html>, 2013.3.15.
- [7] [http://www.ferroxcube.com/FerroxcubeCorporateReception/datasheet/FXC\\_HB2013.pdf](http://www.ferroxcube.com/FerroxcubeCorporateReception/datasheet/FXC_HB2013.pdf), 2014.2.16, pp. 174.