

# THE FRASCATI DAFNE LINAC AND THE BEAM TEST FACILITY (BTF) SETUPS FOR IRRADIATION \*

C. Di Giulio<sup>†</sup>, A. B. Buonomo, F. Cardelli, D. Di Giovenale, L. G. Foggetta,  
 D. Moriggi on behalf of the eRAD project TEAM  
 INFN-LNF, Via E. Fermi 54, 00044 Frascati (RM), ITALY

## Abstract

The Beam-Test Facility (BTF) of the DAΦINE accelerator complex in the Frascati laboratory of the Italian National Institute of Nuclear Physics (INFN) is devoted to the development and testing of particle detectors.

The LINAC and BTF irradiation setups are discussed in this work.

## INTRODUCTION

In April 2020, the upgrade project of the facility with a new line for testing particle detector [1–3] aimed at improving the performance of the facility extending the range of application for the LINAC beam extracted to the BTF lines, in the directions of hosting irradiation test [4] and providing electron irradiation also for industrial users.

The original BTF line is in operation since 2002 [5, 6], and from 2004 operates in opportunistic mode [7] during the running of the Frascati electron-positron collider.

The Conceptual Design Report (CDR) presented in 2016 [8] and the commissioning of the new line are described in [9–11].

From 2022 both lines are available for the users. The main line of the line 1 is dedicated to the PADME experiment, the straight line of the dipole DHSTB002 (see Fig. 1) is dedicated to the irradiation test.

The irradiation test usually requires a non-opportunistic mode of operation of the LINAC, to manage the beam using all the possible range of pulse length, repetition rate and charge to fulfil the requirements of the users. All the possible value of the LINAC setup in dedicated mode are shown in Table 1.

## THE DAFNE LINAC FOR IRRADIATION

The DAFNE LINAC could produce bunches of electrons and positrons for the Beam Test Facility. The BTF is used usually for single particle test of detectors but is authorized to receive up to  $10^{10}$  particles per second, limit useful for the irradiation test.

The DAFNE LINAC working point could be deeply changed from the ordinary setup used for the DAFNE injection at 510 MeV.

To obtain low energy beam up to 165 MeV with a primary electron beam with enough pulse charge that fulfills irradiation test requirements, we need to modify the RF

setup and manage the magnets to transfer this low energy beam in the BTF (see Figs. 2 and 3).

Table 1: The DAFNE LINAC Performances

	Design	Operational
Electron beam final energy	800 MeV	510 MeV
Positron beam final energy	550 MeV	510 MeV
RF frequency	2856 MHz	
Positron conversion energy	250 MeV	220 MeV
Beam pulse rep. rate	1 to 50 Hz	1 to 50 Hz
Beam macropulse length	10 nsec	1.4 to 300 nsec
Gun current	8 A	8 A
Beam spot on positron converter	1 mm	1 mm
norm. Emittance (mm. mrad)	1 (electron) 10 (positron)	<1.5
rms Energy spread	0.5% (electron) 1.0% (positron)	0.5% (electron) 1.0% (positron)
electron current on positron converter	5 A	5.2 A
Max output electron current	>150 mA	500 mA
Max output positron current	36 mA	85 mA
Transport efficiency from capture section to linac end	90%	90%
Accelerating structure	SLAC-type, CG, 2 $\pi$ /3	
RF source	4 x 45 MWp sledded klystrons TH2128C	

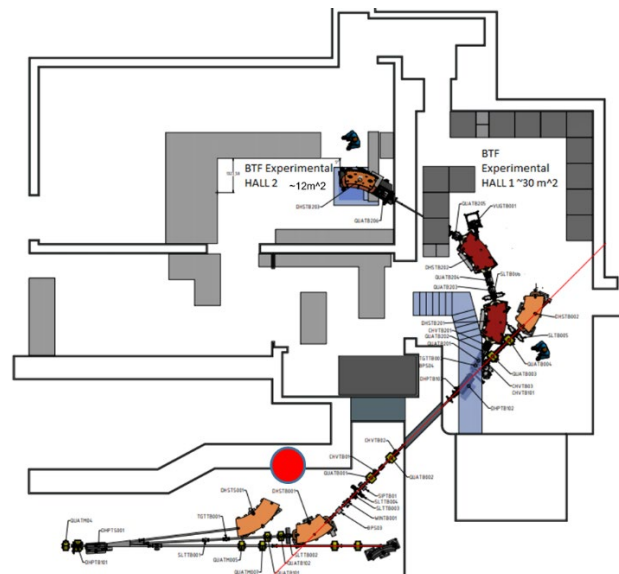

Figure 1: The BTF layout with the 2 lines.

\* Work supported by Regione Lazio with the "Progetti Strategici 2019" public call, within POR-FESR 2014-2020 program

<sup>†</sup> claudio.digiulio@lnf.infn.it

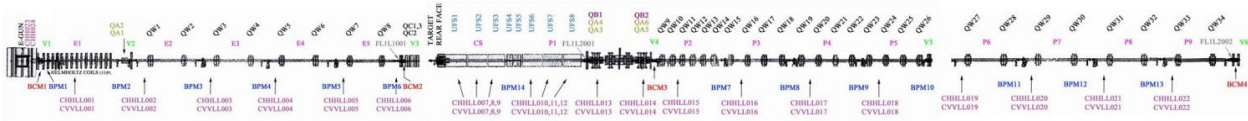

Figure 2: The magnet elements of the LINAC: from the Helmholtz coil near thermionic gun up to the Uniform Field Solenoid near the positron converter, till all quadrupoles and correctors.

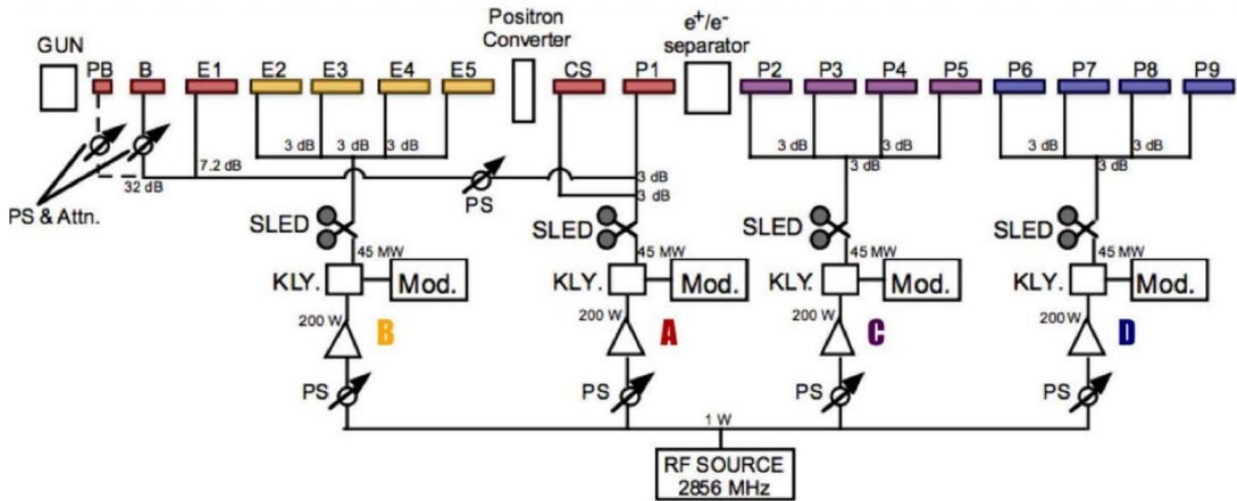

Figure 3: The RF power distribution: to obtain the low energy beam with high charge requested for irradiation we accelerate the beam up to 350 MeV with the RF power station B,A,C and we decelerate it with the power of station D up to 165MeV , we see how we get more power from D station we decelerate more the beam.

The LINAC beam charge and energy spread is monitored transfer one of the pulses of the 50 of the LINAC by a pulsed magnet in the red dot area indicated in Fig. 1 where a second emission monitor system is installed in vacuum. An example of the beam features is shown in Fig. 4 [12, 13].

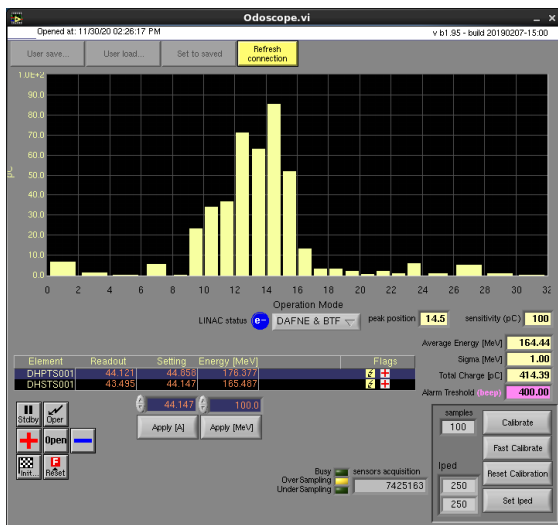

Figure 4: The 165 MeV beam charge and beam spread measured by a secondary emission monitor at the end of the LINAC in the red dot area of Fig. 1.

## THE DAFNE LINAC FOR IRRADIATION

The diagnostic in BTF is described in more details in [14-18].

For the irradiation test an Integrating Current Transformer model ICT-122-070-05:1 by Bergoz was calibrated and installed at the end of the BTF1 line to provide the particle charge per bunch at the users and a flag behind the DUT with the image acquisition system is in operation too, to provide a more precise characterization of the beam delivered for the irradiation.

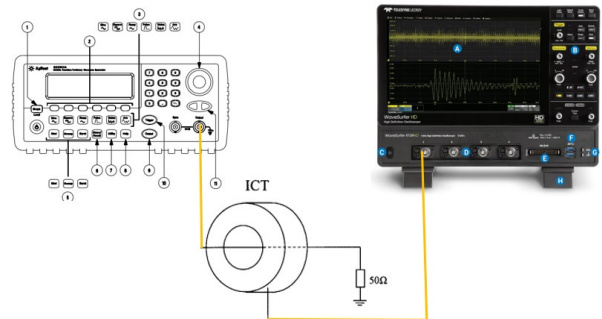

Figure 5: The ICT Calibration Setup: A pulsed signal is acquired by the oscilloscope and the response of the ICT was measured. calibration to measure from  $10^7$  up to  $10^{10}$  particles per bunch.

Content from this work may be used under the terms of the CC BY 4.0 licence (© 2022). Any distribution of this work must maintain attribution to the author(s), title of the work, publisher, and DOI

Another ICT is installed at the end of the LINAC with the same purpose, both signals are acquired and monitored during the irradiation. This allows an optimization of the beam transport and permit to reduce the background in the experimental hall

The BTF ICT signal is acquired by the BTF acquisition system and after having performed a pedestal subtraction, the ADC value is converted to charge. It's composed by a crate VME with a VMIC 7807 that acquire by the VMEbus the QDC(V965b) signal managed by the scaler (SYS 3800) and by the I/O register (CaenV513) more detail in [19]. This system permits to acquire every shot send to the DUT and to show to the user the last 40 shot charge stability.

We test the calibration to measure from  $1^7$  up to  $1^{10}$  particles per bunch using the setup shown in Fig. 5 where a pulsed signal was used to calibrate the ICT.

In Fig. 6 on the left the end of the BTF1 line with the ICT is shown. Behind the DUT (the blue PCB mounted on support) a flag permit to optimize the beam size on the target and a laser permit to center the DUT.

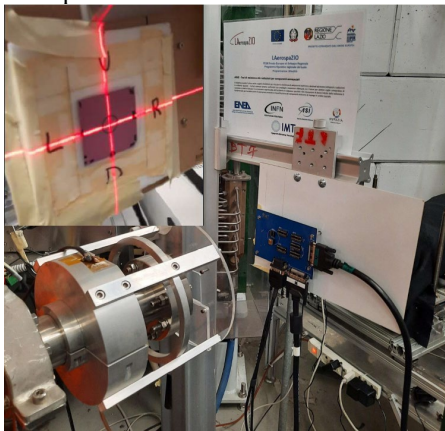

Figure 6: The end of line of the BTF1 where a DUT during the eRAD project irradiation test is shown.

Both the ICT signal are acquired by a TDS3054 Oscilloscope and shown to the user by a LabVIEW interface shown in Fig. 7 where an estimation of the particle per bunch is given.

The image of the shot passed the DUT is acquired and shown in Fig. 8.



Figure 7: On the left the analogic image of the beam. On the right the beam acquired by digital camera (BASLER) and stored by the control system [12-13].

The camera image is acquired at 25 Hz and a gaussian fit procedure of the beam spot is implemented in the control system and store the fit parameter in a database accessible by a web browser.

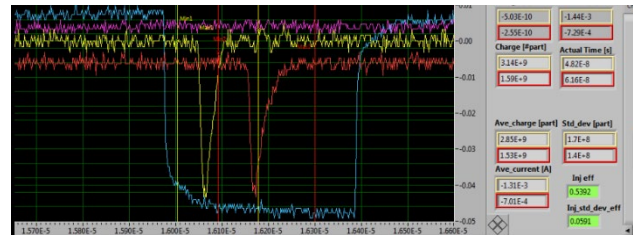

Figure 8: The ICT signals, acquired by the BTF acquisition. The yellow is the charge signal at the end of the LINAC and the red ones is at the end of BTF before the DUT. In the green box the injection efficiency.

## THE ERAD PROJECT

The general aim of the project is the use of electron sources, available at the INFN-LNF to measure the behavior and resistance of electronic components intended to be subjected to radiation in the aerospace environment.

The values and results acquired with these measurements will be compared with homologous measurements performed with photons to define comparative resistance thresholds and related indicators.

Remote tests have been done by using electrons beam with energy of 500 MeV at different values of integrated fluence (up to  $6.48 \cdot 10^{12}$  p/cm<sup>2</sup> and up to  $2.41 \cdot 10^{12}$  p/cm<sup>2</sup>, depending on the device). The test at lower energy is scheduled in July 2022.

Obtained results are very promising and still to be fully interpreted in terms of performances.

## ACKNOWLEDGEMENTS

We thanks to Giovanni Cucinella, Fabiano Boccolini, Gabriele Germani by IMT srl – Via Carlo Bartolomeo Piazza, 30 – 00161 Roma – Italy for the fruitful collaboration in the eRAD project.

## REFERENCES

- [1] A. Rocchi *et al.*, “Linearity and rate capability measurements of RPC with semi-insulating crystalline electrodes operating in avalanche mode”, *JINST*, vol. 15, no. 12, p. C12004, 2020.  
doi:10.1088/1748-0221/15/12/C12004
- [2] V.C. Antochi *et al.*, “Performance of an optically read out time projection chamber with ultra-relativistic electrons” *Nucl. Instrum. Meth. A*, vol. 999, pp. 165-209, 2021.  
doi:10.1016/j.nima.2021.165209
- [3] E. Diociaiuti, “Study of the Mu2e sensitivity to the mu- -> e+ conversion process”, United States: N. p., 2020.  
doi:10.2172/1605578.
- [4] F. Oliva, “Performance of the charged particle detectors of the PADME experiment”, *JINST*, vol. 15, no. 06, p. C06017, 2020.  
doi:10.1088/1748-0221/15/06/C06017
- [5] A. Ghigo and F. Sannibale, “Single Electron Operation Mode in DAFNE BTF”, in *Proc. EPAC'94*, 1995, pp. 2444-2446. doi:10.1142/9789814533744

- [6] A. Ghigo *et al.*, “Commissioning of the DAΦNE beam test facility”, *Nucl. Instrum. Meth. A*, vol. 515, pp. 524-542, 2003. doi:10.1016/j.nima.2003.07.017
- [7] B. Buonomo *et al.*, “Performance and upgrade of the DAFNE Beam Test Facility (BTF)”, *IEEE Trans. Nucl. Sci.*, vol. 52, pp. 824-829, 2005. doi:10.1109/TNS.2005.852704
- [8] P. Valente *et al.*, “Linear Accelerator Test Facility at LNF Conceptual Design Report”, arXiv:1603.05651
- [9] B. Buonomo *et al.*, “The Frascati LINAC beam test facility performances and upgrades”, *Nuovo Cim. C*, vol. 40, no. 1, p. 69, 2017. doi:10.1393/ncc/i2017-17069-6
- [10] B. Buonomo *et al.*, AIDA-2020-NOTE-2016-002 <https://cds.cern.ch/record/2146466>
- [11] L. Sabbatini *et al.*, “Fast Ramped Dipole and DC Quadrupoles Design for the Beam Test Facility Upgrade”, in *Proc. IPAC'18*, Vancouver, Canada, Apr.-May 2018, pp. 3638-3640. doi:10.18429/JACoW-IPAC2018-THPAL011
- [12] G. Di Pirro, C. Milardi, A. Stecchi, L. Trasatti, “DANTE: control system for DAΦNE based on Macintosh and LabVIEW”, *Nucl. Instrum. Methods Phys. Res., Sect. A*, Vol. 352, Issues 1–2, pp. 455-457, 1994. doi:10.1016/0168-9002(94)91568-7
- [13] A. Stecchi *et al.*, “CHAOS General Status Report”, in *Proc. PCaPAC'18*, Hsinchu City, Taiwan, Oct. 2018, pp. 17-21. doi:10.18429/JACoW-PCaPAC2018-WEC5
- [14] L. G. Foggetta, B. Buonomo, and P. Valente, “Evolution of Diagnostics and Services of the DANE Beam Test Facility”, in *Proc. IPAC'15*, Richmond, VA, USA, May 2015, pp. 904-906. doi:10.18429/JACoW-IPAC2015-MOPHA049
- [15] B. Buonomo, D. G. C. Di Giulio, L. G. Foggetta, and P. Valente, “The Frascati LINAC Beam-Test Facility (BTF) Performance and Upgrades”, in *Proc. IBIC'16*, Barcelona, Spain, Sep. 2016, pp. 395-398. doi:10.18429/JACoW-IBIC2016-TUPG29
- [16] P. Valente, B. Buonomo, D. G. C. Di Giulio, and L. G. Foggetta, “Frascati Beam-Test Facility (BTF) High Resolution Beam Spot Diagnostics”, in *Proc. IBIC'16*, Barcelona, Spain, Sep. 2016, pp. 221-224. doi:10.18429/JACoW-IBIC2016-MOPG65
- [17] B. Buonomo, D. G. C. Di Giulio, L. G. Foggetta, and P. Valente, “A Hardware and Software Overview on the New BTF Transverse Profile Monitor”, in *Proc. IBIC'16*, Barcelona, Spain, Sep. 2016, pp. 818-821. doi:10.18429/JACoW-IBIC2016-WEPG73
- [18] P. Valente, B. Buonomo, D. G. C. Di Giulio, and L. G. Foggetta, “DANE BTF Improvements of the Transverse Beam Diagnostics”, in *Proc. IPAC'17*, Copenhagen, Denmark, May 2017, pp. 250-252. doi:10.18429/JACoW-IPAC2017-MOPAB061
- [19] <https://wiki.infn.it/strutture/lnf/da/btf>