

RHIC MACHINE PROTECTION SYSTEM UPGRADES*

M. Valette[†], D. Bruno, K.A. Drees, P.S. Dyer, R. Hulsart, J.S. Laster, J. Morris,
G. Robert-Demolaize, J. Sandberg, C. Schultheiss, T. Shrey, G.M. Tustin,
Brookhaven National Laboratory (BNL) Collider-Accelerator Department, Upton, NY, USA

Abstract

In order to protect the future sPHENIX detector from spontaneous and asynchronous firing of one of the five RHIC abort kickers, mechanical relays were added to the triggering channel for each of them. The mechanical relays add several milliseconds to the delay between the detection of a failure or beam loss and the beam being safely disposed of. In order to account for this delay new inputs were included into the RHIC Machine Protection System to ensure detection of abnormal conditions as early as possible. These inputs include system diagnostics and beam measurements such as Beam Position Monitor signals. In this paper we detail the upgrades that will allow reliable operations with high intensity and high energy ion beams and the new detector as well as related operational challenges and how they were addressed.

INTRODUCTION

During the runs 2014 to 2017 of the Relativistic Heavy Ion Collider (RHIC) a number of pre-fires affected the beam abort system [1]. A pre-fire is a failure case where a thyatron spontaneously discharges a Pulse Forming Network (PFN) through one of the five abort kicker magnets [2], resulting in the beam being kicked partially into the accelerator aperture instead of the beam dump. These events are considered to be triggered by radiation and mostly happen at the end of the energy ramp-up [3]. In the past, pre-fires have been the cause of magnet quenches [4] as well as damage to the experimental detectors and to quench bypass diodes protecting superconducting magnets [5].

From 2023 onward, an upgraded experiment, sPHENIX [6], will be operating in the RHIC facility with the objective of measuring the collisions of a variety of ions circulating at an energy of 100 GeV per nucleon for ions and 255 GeV for protons. To protect this experiment from prefires, mechanical relays were added in series with thyatrons in order to veto an unwanted discharge [7]. Mechanical relays are considerably slower than the thyatrons and can take up to 6 milliseconds to be fully closed. In comparison, the thyatrons have a 0.9 microsecond ramping time and a 15 microsecond "flat" top, the shape of their discharge being responsible for painting the RHIC beam on the beam dump. To account for this extra time to abort the beam an upgrade of the Machine Protection System (MPS) was performed.

* Work supported by Brookhaven Science Associates, LLC under Contract No. DE-SC0012704 with the U.S. Department of Energy.

[†] mvalette@bnl.gov

OPERATION WITH SPHENIX

The PHENIX detector is being installed in IR8, upstream of collimators and one arc downstream from the Abort System on the Yellow ring. Pre-fires would cause partially kicked bunches to hit low- β IR magnets, particle showers would go through detectors and electronics, causing damage. This new Detector for nuclear physics, illustrated in Fig. 1, scheduled to run from 2023 to 2025 will feature the MVTX detector for vertex detection very close to the beam and will run with a crossing angle of 2 mrad which is the configuration where pre-fires could cause the most damage.

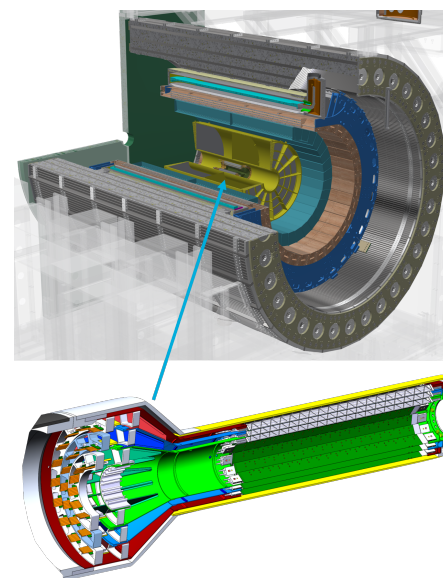

Figure 1: sPHENIX detector with MVTX vertex detector highlighted.

PRE-FIRES

A pre-fire is a degraded behavior of the Abort Kicker system where 1 out of 5 Abort Kicker modules discharges asynchronously, the timeline of a typical pre-fire is illustrated in Figure 2. Both Blue, clockwise, and Yellow, counter-clockwise, rings are affected with around 10 events per year. Most events occur with beam in the last 20 s of the ramp (with voltages above 10.85 kV), they are assumed to be mostly a combination of high voltage and radiation. From Run 9 to Run 13, six occurrences of damage to both detectors were recorded. During Run 15, the PHENIX MPC detector was destroyed after two pre-fires. Such events must be avoided at all costs to ensure the safe operation of the sPHENIX detector.

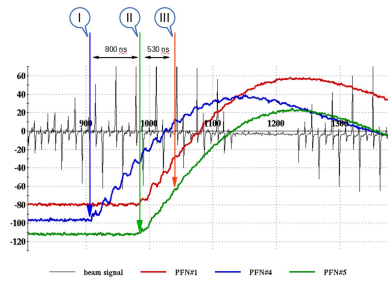

Figure 2: Timeline of a typical Abort Kicker pre-fire. Module 4, in blue, fired by itself (I) and 800 ns later the other modules re-triggered (II), here, only modules 1 and 5 are shown in red and green. The total kick from all 5 modules becomes sufficient to bring the beam to the dump absorber after 530 ns (III), leading to up to 13 bunches affected by the pre-fires with sub-nominal kick angles.

DELAYED ABORT

During subsequent runs, measures were taken to mitigate pre-fires such as movable masks one arc away from Abort Kickers (in IR 8 & 12) to shadow sensitive equipment [3], which proved insufficient. Later, a protection bump using arc magnets to shadow the detector led to high radiation doses and eventually damage to bypass diodes.

In order to veto pre-fires, mechanical relays were added to the triggering line [8] as illustrated in Figure 3. The mechanical movement of these devices implies long timescales of 30 ms to close initially, which was reduced to 6 ms after a spring load upgrade. After being tested in run 18 [9], the delayed mode is now run with 7 ms delay on the Abort Kicker triggering (547 turns) and 10 ms delay to the Quench Switch closing [10], which extracts energy from the superconducting magnet system and is tolerable for magnet protection. The delayed mode is activated after transition crossing during the ramp up and deactivated before injecting new beam. Since 2018 there have been thousands of dumps in delayed mode at various energies and 268 beam aborts in this mode with physics beams.

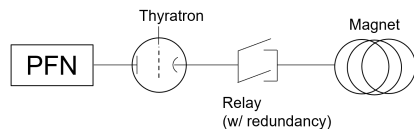

Figure 3: Schematic of the Abort Kicker triggering line with mechanical relays in series with the Pulse Forming Network and the Thyatron.

NEW MPS INPUTS

To account for the longer delay between the detection of a failure and the beam being safely disposed of, new permit inputs were and are still being tested and included to the MPS to ensure early detection of failures and aborting the beam before losses.

MC7: Accelerator Technology

T31: Subsystems, Technology and Components, Other

BPM

40 horizontal and 10 vertical beam position monitors (BPM) in each beam allow monitoring the monitoring absolute position, difference (drift speed) and coherence (min-max). of the beam in critical location like IR and snake magnets [11]. Individual thresholds are set for each BPM and signals in each RHIC mode. They feature a 10 kHz frequency for monitoring and Post Mortem, making it the fastest system in the MPS. This system has been tested operationally since 2019 and is now required for high intensity running. It allows aborting the beam milliseconds (and sometimes seconds as illustrated in Fig. 4) before losses are detected by the Beam Loss Monitors (BLM). This system unfortunately does not protect against failures that do not affect the orbit. BLMs remain the last line of defense [12].

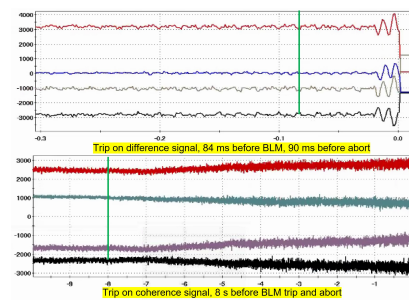

Figure 4: Illustration of BPM-MPS trips providing early detection of an ongoing failure. Top, beam oscillations caught 84 ms before an abort is issued by loss monitors. Bottom, a rising beam instability caught 8 s before loss monitors.

Orbit Corrector Magnets

In case of a Corrector Power Supply failure in one of the alcove where power supplies and electronics are located, the beam can be lost very fast, damage was observed in the past when relying on BLMs alone. This system monitors the power supplies and is very sensitive, allowing to also monitor for perturbation in conventional electric network and cooling. This system was tested since Run 20 and unmasked in Run 21.

Nested Quadrupoles

If a Quadrupole Power Supply (PS) were to fail, the BPMs would not detect it as the orbit is not affected. There have been several occurrences of beam aborted by BLMs during such failures in Run 20. This new system was therefore added for Run 22 with all Interaction Regions equipped, monitoring each type of power supplies in at least one building and all Q7 power supplies. Due to the nested configuration of the powering illustrated in Fig. 5, the monitoring of outer voltage taps (Q7) should allow detecting all failures. Dipole shunt power supplies will not be monitored as they affect the orbit and will be protected against by the BPMs, which was verified during commissioning.

THPOST048

2549

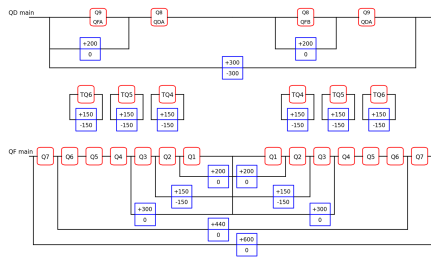

Figure 5: Schematic of the Nested Quadrupole powering scheme for RHIC interaction regions 2, 6, 8 and 12, the Q7 power supply, with 600 A, affects the current in all quadrupoles and is thus the most critical.

REVIEW OF ABORTS

Since run 19, all beam aborts are reviewed systematically, allowing for all unknown trips and abnormal MPS behavior leading to follow up actions and configuration changes to close all openings in the MPS. This methodology allows identifying trends in failures and equipment undergoing stress or aging. A database of all magnet quenches was also created, going back to run 10 to record the quench and damage history of all magnets. Thanks to operational experience failures, Mean Time Between Failures (MTBF) and background losses have been trending down over the years as illustrated in Figure 6.

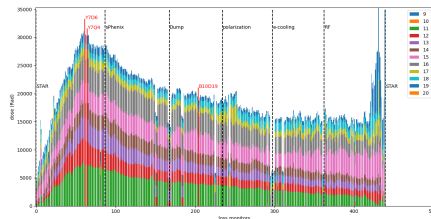

Figure 6: Integrated losses measured by all RHIC loss monitors between Run11 and Run19, the two high-loss areas correspond to the Yellow ring collimator and the sector 5 side of the STAR detector. Locations of burnt diodes are highlighted in red.

DIODE DAMAGE

As mentioned previously the superconducting magnets' bypass diode have been damaged during pre-fire events due to their irradiation over the years. This remains a risk for operations. Ongoing studies to monitor and resolve this issue include:

- the inventory of diode location in cryostats to identify exposed and vulnerable diodes.
- measurements (at room and cryogenic temperatures) of turn-on voltage baseline to identify trends and signs of damaged diodes already damaged.
- simulation studies on the current crowding effect which should allow predicting the onset of damage in terms of

deposited radiation energy and magnet stored energy. The parameter scan for such simulations is illustrated in Fig. 7 and will be the topic of an upcoming paper.

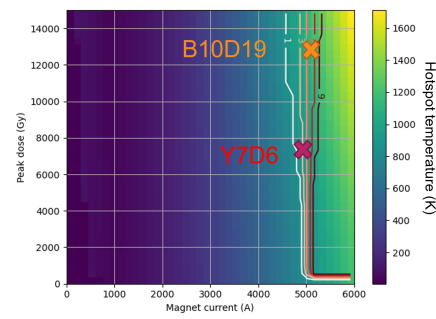

Figure 7: Parameter scan for hot-spot temperature resulting from the finite difference simulation of current crowding in bypass diodes. The contours highlight the proportion of the diode damaged during the discharge and the crosses highlight the initial conditions for two of the burnt diodes from dipole magnets.

EIC DEVELOPMENTS

Looking forward to the future of RHIC, the EIC era of the facility is a few years away and developments are already in progress to prepare for this next phase. This project will feature a full collimation system overhaul for the Hadron ring with a modern two-stage collimation system. As the EIC will require the beams to be radially shifted to ensure synchronicity of hadron and lepton beams, issues such as asymmetric heat loads and chromaticity behavior are being tested during physics experiments.

MPS inputs will be added for all new systems, e.g. : Crab Cavities, Warm Magnets, ... Running with delayed abort for the EIC Hadron Ring is being investigated but is not desirable, potential alternatives for the Abort Kicker triggering are being investigated.

CONCLUSION

Pre-fires are in intolerable failure mode for the upcoming sPHENIX operation. The Mechanical Relays added in 2017 to prevent pre-fires induce a significant delay to the beam abort. Upgrades to the Machine Protection system have been performed to improve reaction time and cover all known failure cases. Systematic analysis of Aborts allow monitoring for new failure modes and trends in critical systems. The Machine Protection System can not protect against failures faster than 6 milliseconds, or against instabilities that would blow up the beam without affecting the orbit, protection against such events rely on knowledge of RHIC beam physics, and in carefully ramping up beam intensity during commissioning.

Content from this work may be used under the terms of the CC BY 4.0 licence (© 2022). Any distribution of this work must maintain attribution to the author(s), title of the work, publisher, and DOI

REFERENCES

- [1] Y. Tan and S. Perlstein, “RHIC Abort Kicker Prefire Report”, BNL, New York, United States, Rep. BNL-105539-2014-IR, 2014.
- [2] W. Zhang, L. Ahrens, J. Mi, B. Oerter, J. Sandberg, and D. Warburton, “Advancement of the RHIC Beam Abort Kicker System”, in *Proc. PAC’03*, Portland, OR, USA, May 2003, paper TPPB007, pp. 1640–1642.
- [3] A. Drees *et al.*, “RHIC prefire protection masks”, BNL, New York, United States, Rep. BNL-107380-2015-IR, 2015.
- [4] M. Bai, K. Brown, P. Oddo, D. Bruno, G. Heppner and C. Mi, “Beam Losses and Beam Induced Quenches at RHIC”, *Workshop on Beam Induced Quenches*.
- [5] K. A. Drees *et al.*, “RHIC Quench Protection Diode Radiation Damage”, in *Proc. NAPAC’19*, Lansing, MI, USA, Sep. 2019, paper WEPLH11, pp. 831–833.
- [6] Rosi Reed for the sPHENIX Collaboration, “A new detector at RHIC, sPHENIX goals and status”, *J. Phys. Conf. Ser.*, vol. 779, p. 012019, Jan. 2017. doi:10.1088/1742-6596/779/1/012019
- [7] P. Ingrassia, “A Long Term Reliability Challenge at the RHIC”, in *Proc. ARW 2017*, Oct. 2017.
- [8] J. Sandberg, “RHIC Abort Kicker Upgrade for Run 17”, *2016 RHIC retreat*, 2016.
- [9] M. Valette *et al.*, “RHIC Delayed Abort Experiments”, in *Proc. IPAC’21*, Campinas, Brazil, May 2021, pp. 126–129. doi:10.18429/JACoW-IPAC2021-MOPAB026
- [10] C. R. Conkling Jr., “RHIC Beam Permit and Quench Detection Communications System”, in *Proc. PAC’97*, Vancouver, B.C., Canada, 1997.
- [11] T. Satogata *et al.*, “RHIC BPM System Modifications and Performance”, in *Proc. PAC’05*, Knoxville, TN, USA, May 2005, paper RPAT028.
- [12] A. Drees, “A close look at beam aborts with rise times less than 40 ms from the years 2014-2016”, BNL, New York, United States, Rep. BNL-112662-2016-IR, 2016.