

CONCEPTUAL DESIGN OF THE C-BAND MODULE FOR THE SWISSFEL

R. Zennaro, J. Alex, M. Bopp, H. Braun, A. Citterio, H. R. Fitze, M. Pedrozzi and J.-Y. Raguin, PSI, CH-5232 Villigen, Switzerland.

Abstract

The Swiss FEL linac consists of a 450 MeV S-band injector and of a main linac at the C-band frequency (5.712 GHz) aiming at a final energy of 5.8 GeV [1]. The main linac is composed of 26 RF modules. Each module consists of a single 50 MW klystron and its solid-state modulator feeding a pulse compressor and four accelerating structures. The two-meter long C-band accelerating structures have 110 cells, including the two coupler cells, and operate with a $2\pi/3$ phase advance.

We report here on RF studies performed on the accelerating structures with different cell topologies and on the pulse compressor where a Barrel-Open Cavity (BOC) design is adopted.

The power requirements for the different accelerating structures with the single and two-bunch operation are also presented.

RF MODULE LAYOUT

The modulator-klystron system is in the technical gallery sitting on top of the accelerator tunnel, the pulse compressor is suspended from the ceiling and the four accelerating cavities (AC) lie on two independent four meter long supports; see Figure 1.

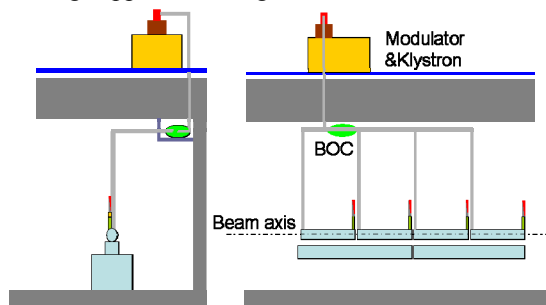

Figure 1: Module layout.

A module has a total length of 8.2 m.

The waveguide distribution is not symmetric, i.e. the waveguide length from the pulse compressor to each cavity is defined both to compensate the bunch delay (6.7 ns per AC) and to keep the same phase at the input couplers.

All the RF components, the modulator and ultimately the full assembled module will be power tested in a dedicate test stand at PSI.

ACCELERATING STRUCTURES

Constant gradient structures have the advantage of providing uniform power loss along the structure which simplifies the cooling design and the temperature stabilization of the cavities.

The C-band accelerating structures designed at PSI consist of 110 cells, including the two coupler cells of the J-like type, and operate with a $2\pi/3$ phase advance. The choice of the C-band is dictated by length and power consumption issues. The length of each cell is 17.495 mm and the active length of each structure is 1.92 m with a nominal energy gain per AC of 52.5 MeV. Three cell topologies are under study: the disk-loaded cell (Figure 2 A), the cup-like cell (Figure 2 B) and the rounded-wall cell (Figure 2 C). Each type of cell has elliptical shaped iris tips to decrease the peak surface electric field.

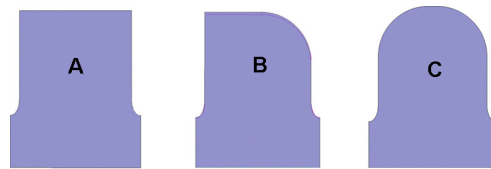

Figure 2: Sketch of the three different designs of the cells.

The variation of the group velocities and of the r/Q is a function of iris radius, for an iris thickness of 2.5 mm (the minimum achievable for mechanical rigidity reasons), and is approximately the same for all three types of cell. However, for a given iris radius, the quality factor of the disk-loaded cells (A) is 4 % lower than for the cup-like cells (B) and 10% lower than for the cells with double rounding of the walls (C). The filling time is similar for the three designs and is 305 ns. The basic RF parameters along the structures for topology B are shown in Figure 3.

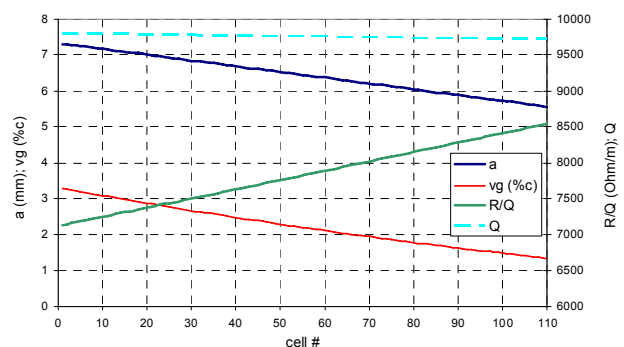

Figure 3: Basic RF parameters of the cup-like structures.

For all three topologies the average iris radius is dictated by longitudinal short-range wakefield considerations and beam dynamics related requirements.

Multi-bunch operation also requires a careful study of the long-range wakefields. The first two dipole bands have been studied with the use of an equivalent circuit model showing negligible effects on the beam. The long range longitudinal wake has also been studied with an equivalent procedure; also in this case the wakefield effect on the beam is unimportant. Full-scale structure

computations of the wake with an appropriate code are envisaged anyway in order to confirm the results of the equivalent circuit model.

Ultimately the choice of the cell type will be dictated by manufacturing issues, each type of structure having different brazing planes of the cells, by cost and by the RF efficiency of a whole module. For this reason a brazing test program is under way at PSI, see Figure 4.

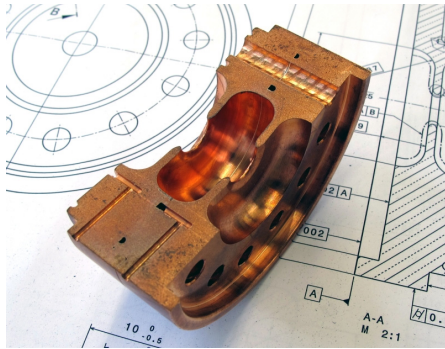

Figure 4: Vacuum brazing test of two cups.

RF POWER GENERATION: MODULATOR AND KLYSTRON

One of the most critical components is the C-band klystron. The main parameters of the klystron fulfilling PSI specifications are listed in table 1.

Table 1: Klystron Technical Data

Parameter	Value
Peak RF Power	50 MW
RF Pulse Width	3 μ s
Repetition Frequency	100 Hz
Cathode Voltage (max)	370 kV
Beam Current (max)	344 A
High Voltage pulse width	6.2 μ s

A competitive call for tender is pending; only one company (Toshiba) at the present time can fulfil the specifications, with the exception of the repetition rate and the high voltage pulse width. The existing design from Toshiba (E3746A) can work at 60 Hz while the required repetition rate is 100 Hz [2]. The modulator design is not yet finalised. We are investigating different options. A preference is given to a solid state modulator versus a pulse forming network modulator.

The critical issue for the modulator is the pulse-to-pulse stability. In PSI solid state modulators from ScandiNova are already in operation for the S-Band RF systems at the SwissFEL Injector test facility [3]. They show a pulse-to-pulse stability of better than $4 \cdot 10^{-5}$. It is foreseen to order a first C-Band modulator prototype for SwissFEL in the near future. This modulator will be optimised for the mechanical constraints given by the building layout. The prototype will be tested inside our RF test stand.

01 Electron Accelerators and Applications

1A Electron Linac Projects

RF PULSE COMPRESSOR

The key device of the RF power distribution is the pulse compressor; the chosen solution for SwissFEL is the Barrel Open Cavity (BOC) [4].

No BOC pulse compressor exists at the moment at C-band. A new design has been studied in PSI and is based on the use of the $TE_{18,1,1}$ mode which could provide a very large Q factor (computed 220,000) and compactness. A schematic view of the BOC for SwissFEL is shown in Figure 5 and the electric field configuration in Figure 6.

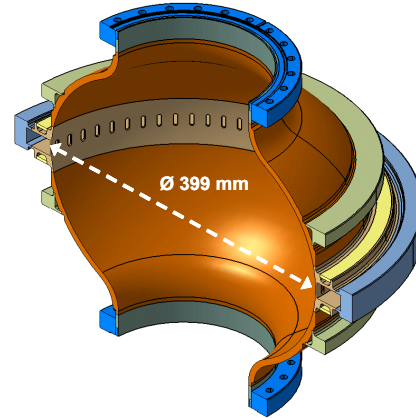

Figure 5: Sketch of the C-band BOC.

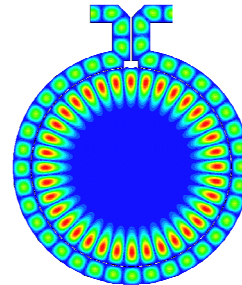

Figure 6: Electric field magnitude in the BOC.

The rotating whispering-gallery $TE_{18,1,1}$ mode is kept in phase with the TE_{10} travelling-wave mode of the waveguide surrounding the cavity by carefully adjusting the waveguide width. The field configuration allows easy suppression of potential neighbouring modes since the electromagnetic field of the working mode is completely absent in the inner part of the cavity. All the other modes can be damped via the insertion of a dielectric cylinder. In the absence of damping material the BOC in any case has no resonance in a range of 100 MHz around 5.712 GHz.

The coupling factor (β) is determined by a proper geometry of the 68 coupling slots which are spaced by $\lambda_g/4$. The present design has “racetrack” slots that can provide a β equal to 11. This design allows a large β with a relatively thick wall (1.8mm) which should simplify the fabrication.

The value of β has been chosen to optimise the system composed of the pulse compressor and four cup-type constant-gradient accelerating structures with a filling

time of 305 ns and an RF pulse length of 2.5 μ s; see Figure 7.

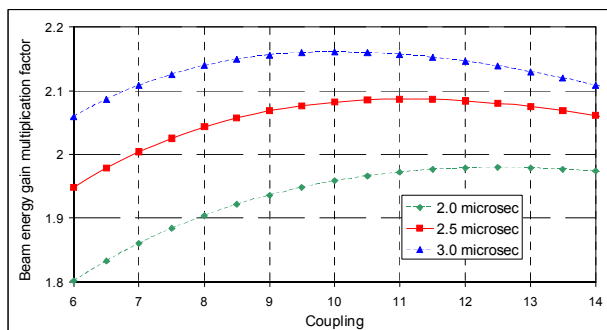

Figure 7: Beam energy gain multiplication factor as a function of the coupling for three different RF pulse lengths.

TWO BUNCH OPERATION

SWISSFEL can operate with either one or two bunches that can be sent to two different FEL beam lines and undulators by a fast kicker system. Three different schemes have been considered to provide the correct pulse modulation to properly accelerate both bunches: phase modulation of the klystron driver (1), acceleration of the second bunch when the ACs are not completely filled with RF (2) and amplitude modulation provided by combining two klystrons via a hybrid (3).

Clearly the last solution is the only one that can provide a flat pulse without any phase drift; it is ideal for multi-bunch operation but it is also the less efficient because part of the power is lost in the load of the hybrid; it also reduces the modularity of the linac system and increases the relative costs of spare components.

The first and second solutions have the same hardware configuration as shown in figure 1.

The three different schemes have been compared for 50 ns spaced bunches and 2.5 μ s, with 40 MW klystron output power and assuming extra 20% losses in the waveguides; see Figure 8.

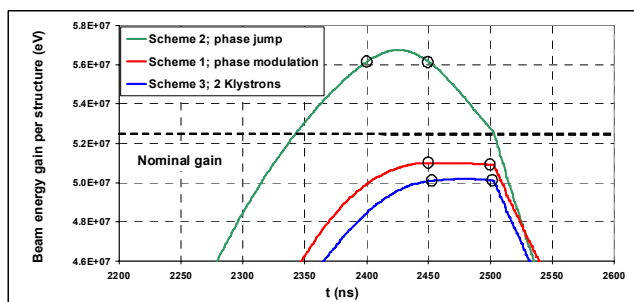

Figure 8: Beam energy gain per structure vs. time for 40 MW klystron output power and 2.5 μ s pulse.

The most efficient solution is clearly provided by scheme 2. The energy gain per cavity is 56 MeV, well above the nominal value of 52.5 MeV; this solution has the disadvantage of not having active knobs to adjust the beam energy-gain profile of Figure 8, which is defined

only by the parameters of the BOC, which is a passive device.

The two bunches must have the same energy and energy spread i.e. the same integrated voltage and integrated slope.

This can be obtained with the phase modulation scheme (1) which requires a small detuning of the pulse compressor by properly adjusting the cooling water temperature.

In the example illustrated in Figure 8, the detuning of the BOC is of 345 kHz and is equivalent to a linear phase variation of 320° over a pulse of 2.5 μ s.

The bunch spacing has a strong impact on the power consumption; it is determined by the design of the switching magnet, and should allow the required damping of the long-range transverse and longitudinal wakefields.

A comparative study of the three schemes of pulse compression for the three different accelerating structure designs is illustrated in Figure 9.

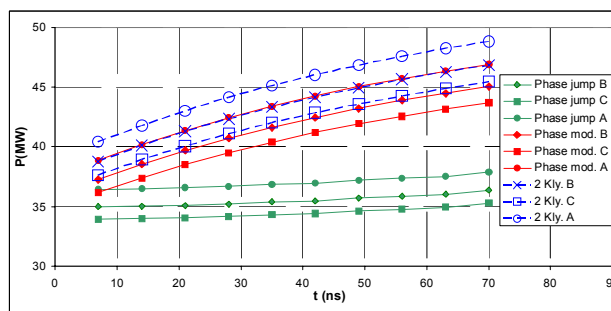

Figure 9: Klystron output power vs. bunch spacing.

The klystron output power should not greatly exceed 40 MW to keep safe operational margins; thus the favoured bunch spacing is around 30ns which, according to the results of the circuit model, seems to be acceptable in terms of wakefields. This bunch spacing allows operation with both schemes 1 and 2. A study of a resonant switching magnet capable of such bunch spacing is in progress.

ACKNOWLEDGEMENT

The authors would like to express their sincere gratitude to Igor Syratcev for his advices on the design of the pulse compressor.

REFERENCES

- [1] R. Ganter et al, SwissFEL CDR, PSI report n. 10-04; http://www.psi.ch/swissfel/HomeEN/SwissFEL_CD_R_web_small.pdf.
- [2] E3746A TOSHIBA Klystron; http://www.toshiba-tetd.co.jp/eng/electron/e_kly.htm.
- [3] M. Pedrozzi, "250 MeV Injector facility for the SwissFEL project", Proceedings of FEL2009, Liverpool, UK.
- [4] I. Syratcev, "RF pulse compression system for CTF3", MDK Workshop, CERN, April 2001.