

SPIRAL2 ACCELERATOR CONSTRUCTION PROGRESS

P. Bertrand, R. Ferdinand, GANIL, Caen France,
on behalf of the SPIRAL2 team and partners.

Abstract

The installation of the SPIRAL2 superconducting accelerator at GANIL is almost started. All the major components have been tested in the various partner laboratories, and the building construction is now well engaged. The management of the interfaces between the process and the buildings is a strategic point in an underground accelerator, with strong space constraints. This paper describes the performances of the various components.

INTRODUCTION

Officially approved in May 2005, the SPIRAL2 radioactive ion beam facility at GANIL (Caen-Normandy) has been launched in July 2005, with the participation of many French laboratories (CEA, CNRS) and international partners. Figure 1 describes the project layout. In 2008, an important decision has been taken to build the SPIRAL2 complex in two phases:

- *Phase one* includes the complete accelerator and two new experimental halls, the Super Separator Spectrometer (S3) and the Neutron-based research area (NFS), all to be installed in a new dedicated building.
- *Phase two* includes the RIB production process and building, the low energy RIB experimental hall (DESIR) and the transfer line connection to the present GANIL facility for RIBs post-acceleration by means of the existing SPIRAL1 cyclotron called CIME.

The planning objective of the first phase is to have installed and tested the whole accelerator in order to start the experiments with NFS and S3 in 2014-2015. A complete presentation of the SPIRAL2 scientific case can be found in the White Book of SPIRAL2, and through the large number of Letters of Intent for physics [1] [2] [3].

Recalled in table 1, the SPIRAL2 accelerated beams will include protons, deuterons, $A/q < 3$ ions, and optionally $A/q < 6$ ions in the future. As indicated, a maximum beam power of 200kW is expected for deuterons in CW mode.

Table 1: Beam Specifications

beam	P+	D+	ions	ions
Q/A	1	1/2	1/3	1/6
Max. I (mA)	5	5	1	1
Min. output E (MeV/A)	2	2	2	2
Max output E (MeV/A)	33	20	14.5	8
Max. beam power (kW)	165	200	44	48

During the last years, our strategy for the accelerator itself was the following:

We decided a few years ago to install the low energy

heavy ion transfer line and ECR source at LPSC laboratory (Grenoble), and the Deuteron/proton ones at IFRFU/Saclay, in order to operate a maximum of technical and beam tests, to check the validity of our design, and to improve with all partner laboratories our knowledge and collaboration. This will also gain time for the definitive installation and tests at GANIL.

Thanks to our partnership with existing accelerators (SARAF, INFN-HH, GANIL...), we were also able to test various components like diagnostics in presence of existing beams, and to have some irradiation tests on samples to check their resistance to radiations and to validate the activation codes.

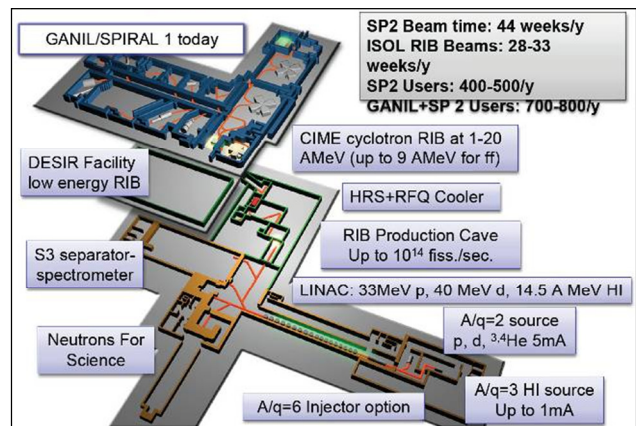

Figure 1: SPIRAL2 project layout, with experimental areas and connexion to the existing GANIL.

In the next paragraphs, we will focus essentially on the first phase of the project, providing the status of the main parts of the accelerator, the progress of construction of its building, and some scheduling.

SPIRAL2 INJECTOR STATUS

The Spiral2 injector, dedicated to protons, deuterons and heavy ions of $q/A > 1/3$, is mainly composed of two ECR ion sources with their associated LEBT lines, a warm RFQ and the MEBT line connected to the LINAC.

Heavy ECR ion source, and LBET1

The 18GHz ECR heavy ion source, called Phoenix-V2, and its analysis beam line LBET1 have been installed at the LPSC/Grenoble for a few years (Figure 2). The ECR source was updated these last years, in particular to host metallic ovens developed at GANIL.

Here are summarised the main results obtained: (see also [4] and [5] for more details) :

- Using automated optimization algorithms developed

from the TraceWin code, we obtained in a first step 30% more than 1 mA of $^{16}\text{O}^{6+}$ (goal for SPIRAL2), and 70 μA of $^{40}\text{Ar}^{12+}$, with a good transmission (95%). Around 2 mA of $^4\text{He}^{2+}$ were also obtained, which is of interest to mimic the deuteron beam and learn how to tune the Linac.

- As expected, we measured transverse emittances of around $0.25 \pi \cdot \text{mm} \cdot \text{mrad} \cdot \text{norm} \cdot \text{rms}$., with an efficient action of the hexapole corrector associated to the analysis bending magnet. Very similar transverse beam profiles in both pulsed and CW source mode were also obtained.
- The separation power of the LEBT1 line is found better than specified. ($<1/100$), which is a good sign for future Linac acceleration.
- Recent improvements allowed us to reach our 60 kV voltage goal in routine operation, mandatory for RFQ injection of $A/Q=3$ beams.
- We also obtained more than 20 μA of $^{58}\text{Ni}^{19+}$, which is very promising (Figure 3).

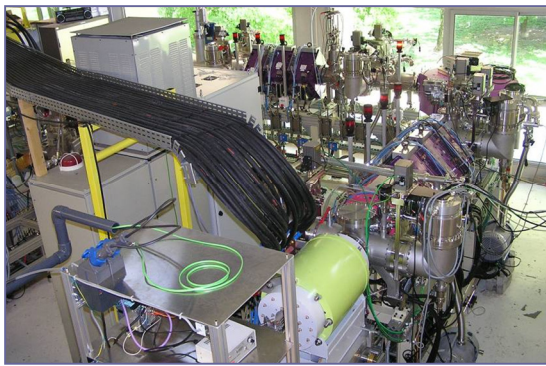

Figure 2: View of ECR source (green) and Spiral2 LEBT1 installed at LPSC (Grenoble) for beam tests.

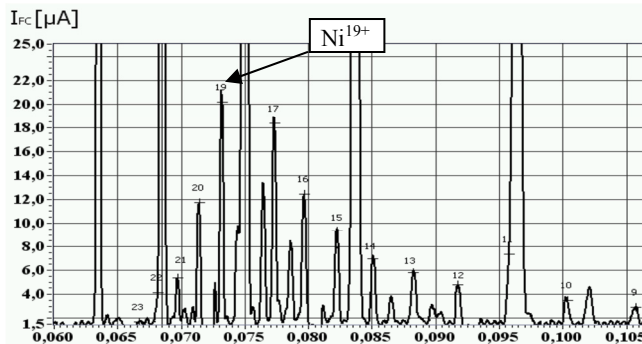

Figure 3: Spectrum optimized for Ni^{19+} ($\sim 20 \mu\text{A}$), using the Large Capacity High Temperature Oven from GANIL (please zoom for details).

Several actions are now conducted: a development is underway to increase the volume of the plasma chamber, and a study is conducted by LPSC, GANIL and IPN/Lyon to develop a new fully superconductive 18/28 GHz ECR source.

Moreover, LEBT1 having been dismantled last June to be moved to the SPIRAL2/GANIL site, Phoenix-V2 will be reconnected to another LPSC test bench in order to continue metallic beam development with $^{40}\text{Ca}^{14+}$ and $^{40}\text{Ca}^{16+}$ up to the last moment.

ISBN 978-3-95450-122-9

Deuteron ECR ion source, LEBT2 and LEBTC

Important results were also obtained in 2010-2012 at IRFU/Saclay, where the deuteron/proton ECR source, the transfer lines LEBT2 (achromatic analysis section) and LEBTC (merging transport and matching line to the RFQ) have been installed in several successive steps (Figure 4).

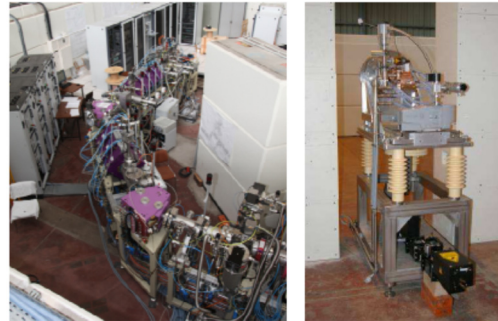

Figure 4: View of ECR source, and LEBT2+LEBTC installed at IRFU (Saclay) for beam tests

Here are the main results obtained during the last months:

- First of all, the 2.45GHz permanent magnet ECR source [6], confirms its capability to produce a very stable and reproducible 6.7 mA 40 kV deuteron CW or pulsed beam (and also down to 50 μA in CW), with an emittance between 0.1 and 0.22 $\pi \cdot \text{mm} \cdot \text{mrad} \cdot \text{norm} \cdot \text{rms}$, depending upon the tuning of the slits and the vacuum level.
- Beam alignment and automatic optical procedures showed very efficient behaviors, with transverse emittance portraits and perfect RFQ matching parameters achievements: By installing the emittance-meter at the *exact* RFQ injection point, we could measure the emittance (distorted) figures and by generating a set of 10^6 particle reproducing them, we could check with the Tracewin code that the real beam should be correctly bunched and accelerated through our RFQ (Figure 5).
- We also verified that the set of movable LEBT slits were efficient to clean optimally the generated halo, and that we could chose the vacuum level in order to optimize the space charge compensation parameter.
- The slow chopper, developed by INFN Catania, could be tested on line and gave excellent results [7]: Transition times below 30 ns were confirmed as well as the duty cycle range from 0.1% to 99.99%. The device can operate up to 10 kV, up to 1 kHz. The chopper will be used to manage the beam duty cycle. It is also a Machine Protection System device which stops the beam when an unwanted event occurs (lost beam, internal failure, etc...)
- Finally, we had also the opportunity to discover some technical weak points like the response delay of the magnet power supplies, and test successfully on line the corrections proposed by the constructors.

The entire installation will be dismantled this month, to be moved to the SPIRAL2/GANIL site.

02 Proton and Ion Accelerators and Applications

2G Other Proton/Ion

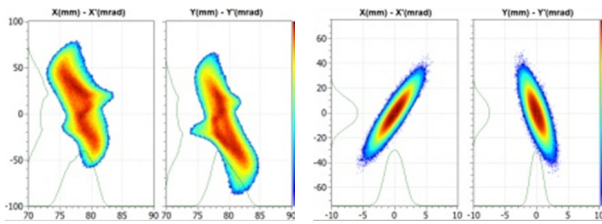

Figure 5: D^+ measured emittances as input for Toutatis RQF transport, and output emittances obtained.

Status of the 88 MHz room temperature RFQ

Developed by IRFU/Saclay, the RFQ is a 4-vane, 88MHz, 5-meter copper cavity ensuring bunching and acceleration of the continuous beam up to 0.75MeV/u [8].

The first RFQ segment was constructed, 3D-measured and accepted in May 2010, while the 4 other segments are in progress: The 4 last tubes are manufactured and assembled with their respective vanes in pre-machined state ($\approx 500 \mu\text{m}$) and measured with success (Figure 6). Final vane machining and geometrical checks should be achieved by end 2012.

The main issue is a vacuum leak observed last year for the first segment: this point, under strong investigation, is perhaps due to a too soft copper, to non conformities on surface roughness, and to previous non conformities of vacuum seals.

In parallel the integration system of the RFQ segments is ready, and the cooling system call for tender launched.

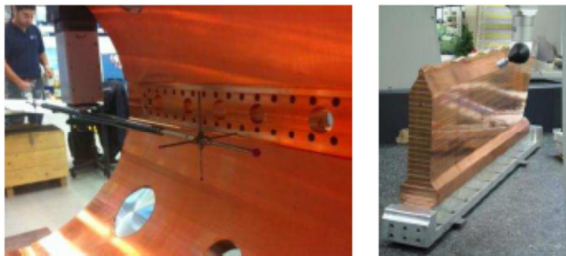

Figure 6: 3D measurement of RFQ tubes and vanes

Medium energy beam transfer line

The intermediate 8-meter MEBT line ensures several essential functions: the matching of the 0.75 MeV/A bunched beam from the RFQ exit to the SC Linac, the connection of a future $q/A=1/6$ heavy ion injector, a very fast selection by clean chopping of the beam bunches for NFS experiments, and the suppression of the beam halo before injection into the Linac.

The first (among three) *rebuncher* (Figure 7) [9] was intensely tested last year at full power, results leading to an increased cooling of the trimmer plates. The other two cavities are now being built. Recently, the 1st rebuncher was also used for tests of the whole RF system, including the amplifier, the LLRF, the PLC for the controlled trimmer motor and EPICS/Xal related applications.

The fast chopper (figure 7), or “single bunch selector” must reduce by 100 to 10000 the bunch rate for NFS experiments. It is based on the superposition of a steerer magnet and 2 high impedance meander electrodes driven

with high voltage pulses of opposite sign. A vacuum chamber prototype equipped with 100Ω meanders and feed-through have been constructed in collaboration with INFN-LNS and successfully tested in Catania [10].

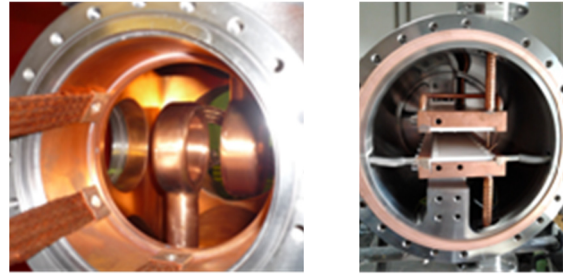

Figure 7: MEBT 3-gap rebuncher and single bunch selector.

For the beam commissioning, a diagnostic plate will be installed after the 1st MEBT rebuncher, allowing precise measurement of the RFQ output beam parameters.

SPIRAL2 LINAC AND HEBT STATUS

The LINAC accelerator [11][12][13][14] is a superconducting linac composed of two types of QWR cavities, $\beta=0.07$ and 0.12 operating at 88.05 MHz, with intermediate warm sections, housing quadrupole doublets, diagnostics and vacuum pumps.

The 12 low- β cavities were all qualified in vertical cryostat, the last one in July 2012 at IRFU/Saclay (in charge of the development of the A-type cryomodules). The 14 high- β ones were already successfully tested in 2010 at IPNO/Orsay (in charge of the B-type cryomodules). LPSC/Grenoble is in charge of the development, production and ongoing commissioning of the 12kW power couplers. For each family, a “qualification” cryomodule has been tested with some success before the production of the series cryomodules (although not with completely nominal performances).

RF power tests campaigns were performed on the qualification and pre-series cryomodules. The results showed several major difficulties, mainly related to high RF dissipations in the cavities on both cryomodule types. The main source of dissipation in the cavity, even at low accelerating field (i.e. $< 6.5 \text{ MV/m}$), was the electron field emission. The pollution sources are now understood, coming from unexpected dirty parts from vendors, partly inadequate cryomodule assembly procedures, inappropriate venting procedure, and probably also from power coupler surface cleanliness. Qualification of the cryomodules subcomponents and the power coupler preparations were entirely reviewed.

We are still facing a long commissioning time. The low Q_{ext} coupler values ($5.5 \cdot 10^5$ for CMA and $1 \cdot 10^6$ for CMB) are obtained by a deep penetration of the antennas inside the cavity. Thus, the field at the antenna tip is of the same order of magnitude than the accelerating field of the cavity. As a consequence the RF processing of the power coupler mounted on the cavity had to be also improved.

All these efforts lead recently to the acceptance of the first A-type cryomodule for installation on the machine.

In parallel, all the vacuum boxes of the *warm sections* are achieved, with mechanics assembly in a clean room.

The *cryogenic system* is almost finished [15]: the valve boxes and 1.1kW Helium liquefier are constructed, with the cold box tested with success in the company last June. [15]

The *HEBT lines* are completely defined, with all dipoles constructed and being measured, while qpoles and steerers are under construction, and the call for tender of the main beam dump imminent [16].

DIAGNOSTICS

A set of 50 semi-interceptive multi-wire profile monitors and 5 non interceptive monitors (residual gaz ionization) are developed at GANIL, using the same specific modular electronic and acquisition software. We will be able to measure all types of beams from 10pA to 5mA (pulsed mode), and from 1nA to 5mA (CW mode) [17][18]. The complete series is underway. The new electronics has been validated.

LEBT and MEBT Emittance-meters developed by IPHC/Strasbourg are now fully operational.

BPM capacitive probes have been developed (IPN/Orsay and BARC/India) [19]. They are buried into the LINAC qpoles, allowing position, ToF measurement, and transverse beam tuning ($\pm 0.15\text{mm}$ resolution). One prototype was tested with success using the SARAF facility beam. Beam Extension Monitors (BEM) are under development for longitudinal tuning (IPNO and GANIL).

The survey of the beam intensity and the energy, is ensured by several ACCT/DCCT devices, and a ToF system installed at the exit of the Linac ([20][21]).

Several Faraday cups, developed by GANIL are already operational, the remaining ones being launched.

The BLM scintillator detectors associated with photo-multipliers are developed by IFIN-HH/Bucarest, and will be disposed along the Linac (1.5 m) and HEBT in order to deliver a “beam stop” signal in case of excessive beam losses. The BLM detector is now developed and tested with beam, and the final associated fast acquisition system ready (10 μs) to be reviewed before fabrication.

AMPLIFIERS



Figure 8: First cabinets of solid state amplifiers being tested at GANIL on the variable VSWR test bench.

Recent RF system progress concerns the solid state amplifiers. First 2.5 kW, 5 kW, 10 kW and 19 kW units are being commissioned and fit the project requirement: 4% of reflected power, at any phase and at nominal output power (figure 8). The amplifiers are class AB, use in-phase combiners and show good operating symmetry and phase shift. They are equipped with BLF 578 transistors, each of them providing up to 700W continuous power.

The architecture is based on 5 kW water cooled racks (<25Kg), installed in a 750A-48V cabinet. It includes the combiners installed behind the racks and the drivers with fast protection digital controllers. A single main cabinet contains the control, fuses and a PLC for supervision.

COMMAND/CONTROL

The Spiral2 control system [22][23][24] is based on the Epics environment, and graphic user interfaces using CSS/BOY or home-programmed Java applications within a specific SPIRAL2 framework derived from OPEN-Xal. PLCs have in charge specific devices (ion source, RF, vacuum, cryogenic distribution...), and handle safety processes (beam interlocks, run permit system...).

During the Grenoble and Saclay beam tests, many C/C components and high level applications were successfully used, with the opportunity to validate most of the interfaces (power supplies, profilers, Faraday cups, emittance-meters...). We could also perform the beam alignment and optimization, and halo suppression.

Other developments are also in progress, like equipment description tools, relational database, archiving system, e-logbook, and specific interfaces with beam loss diagnostics and the Machine Protection System [25].

PHASE-1 BUILDING



Figure 9: View of the construction site (May 2012)

Figure 1 in the introduction indicates the positioning of phase-1 and phase-2 buildings with respect to the existing GANIL facility. The sufficient advancement of the phase-2 process and its building concept made it possible to define and start the construction of the accelerator-S3-NFS building as a first step of the entire project (Figure 9). The phase-1 building is positioned in such a way to allow a future Linac extension. The main steps and dates of the phase-1 construction are recorded below:

- Acceptation of the construction permit (October 2010)
- Beginning of excavation (January 2011)

- Geotechnical and geologic studies (May 2011)
- First concrete (September 2011)
- Installation of geodesic surface network (January 2012)
- Infrastructure equipments (tanks, insert) (March 2012)
- First paintings and resins of the low energy building block (July 2012).

INSTALLATION SCHEDULE

The schedule of the construction site is organised in such a way, that it is possible to install progressively the process inside the building, starting with the low energy beam lines (underground) and the corresponding power supply and utilities (superior floors), in parallel with other part of the building construction (HEBT for example).

On site, the process installation already started with the geodesic inserts. Using the outside geodesic network installed in 2011 and linked to the topometric network of the existing GANIL, land surveyors are now transferring the information underground (-9.5m) to prepare SPIRAL2 accelerator, NFS and S3 installations [26].

The installation of the accelerator parts will start during the last 2012 trimester with the various LEBTs. Then, the integration will continue as fast as the building construction, accelerator part deliveries and human resources permits. A great care is obviously taken to coactivity between the process and building teams. The injector beam commissioning, including the RFQ beam on the D-plate, should be made possible before the building final reception. Otherwise, the first deuteron Linac acceleration is linked to the safety authorisations and cannot happen before the first months of 2014. A strong work from the whole GANIL team is ongoing in order to provide beam to physics as soon as possible.

CONCLUSION

All the SPIRAL2 accelerator components are in a phase of technical tests and/or final construction. The progress of the accelerator building allows us to begin now the installation of the process, thanks to the work and motivation of all our partners.

ACKNOWLEDGEMENT

The two authors thank all the colleagues who helped them to collect the information presented in this document.

REFERENCES

- [1] The scientific objectives of the SPIRAL2 project. http://pro.ganil-spiral2.eu/spiral2/what-is-spiral2/physics-case/at_download/file
- [2] R. Ferdinand and P. Bertrand, "Status and challenges of the SPIRAL2 facility", LINAC2010, Tsukuba, Japan, September 2010.
- [3] E. Petit, "progress of the SPIRAL2 project", IPAC2011, San Sebastian, Spain, September 2011.
- [4] C. Peaucelle et al., "First A/Q=3 Beams of Phoenix V2 on the heavy low energy beam transport line of SPIRAL2", ECRIS2010, Grenoble, France
- [5] J.L. Biarrotte et al., "First beams produced by the

- SPIRAL2 injectors", Linac 2010, Tsukuba, Japan.
- [6] R. Gobin et al., "Development of a permanent magnet ECR source to produce a 5mA deuteron beam at CEA Saclay", LINAC 2004, Lübeck, Germany.
- [7] A. Caruso et al., "The LEBT chopper for the SPIRAL2 project", IPAC2011, San Sebastian, Spain, September 2011.
- [8] R. Ferdinand et al., "Spiral2 RFQ design", EPAC 2004, Luzern, Switzerland, July 2004.
- [9] M. Di Giacomo et al., "Design of the MEBT rebunchers for the SPIRAL2 driver", LINAC08, Victoria, Canada, September 2008
- [10] M. Di Giacomo, A. Caruso et al., "Measurement of the first prototype of the SPIRAL2 SBS selector". IPAC2012, New Orleans, Mai 2012.
- [11] P. Bosland et al. "Status of the low beta 0.07 cryomodules for SPIRAL2", IPAC 2011, San Sebastian, Spain, September 2011.
- [12] P.E. Bernaudin et al., "Status of the SPIRAL2 superconducting linac", IPAC 2010, Kyoto, Japan.
- [13] G. Olry et al "SPIRAL2 Cryomodules: Status and First Tests Results", SRF2009.
- [14] Y. Gomez-Martinez et al., "Power Couplers for SPIRAL2", SRF2011.
- [15] S. Crispel et al., "Cryogenic system design for SPIRAL2 project at GANIL", IPAC2010, Tokyo.
- [16] L. Perrot et al., "HEBT lines for SPIRAL2 facility: What to do with the accelerated beams", HB2010, Morschbach, Switzerland, October 2010.
- [17] L.L. Vignet et al., "the beam profile monitors for SPIRAL2", DIPAC2009, Basel, Switzerland.
- [18] P. Ausset et al. "SPIRAL2 injector diagnostics", DIPAC2009, Basel, Switzerland".
- [19] M. Abdillah et al. "Development of the beam position monitors for the SPIRAL2 Linac", IBIC 2012, to be published.
- [20] W. Lecoq et al., "SPIRAL2 Beam energy measurement", DIPAC2011, Hamburg, Germany.
- [21] Ch. Jamet et al. "Beam intensity and energy control on the SPIRAL2 facility", this conference.
- [22] E. Lecorché et al., "Overview of the SPIRAL2 control system progress", ICALEPS1011, Grenoble, France, October 2011.
- [23] P. Gillette et al., "SPIRAL2 control command: first high-level JAVA applications based on the IPENXAL library", ICALEPS1011, Grenoble, France, October 2011.
- [24] D. Touchard et al., "The SPIRAL2 radiofrequency command control", ICALEPS1011, Grenoble, France, October 2011.
- [25] M-H. Moscatello, "Machine protection system for the SPIRAL2 facility", IPAC2012, New Orleans, USA, May 2012.
- [26] R. Beunard et al. "Overview on the Preliminary Geodetic Network for SPIRAL2 Process Installation at GANIL", IWAA2012, Batavia, USA, Sept. 2012.