

FRONT-END LINAC DESIGN AND BEAM DYNAMICS SIMULATIONS FOR MYRRHA *

C. Zhang[#], H. Klein, D. Mäder, H. Podlech, U. Ratzinger, A. Schempp, R. Tiede, M. Vossberg
 Institut für Angewandte Physik, Goethe-Universität, D-60438 Frankfurt a. M., Germany

Abstract

A 17MeV, 176MHz, and CW (Continuous Wave) proton linac is being developed as the front end of the driver accelerator for the MYRRHA facility in Mol, Belgium. Based on the promising preliminary design, further simulation and optimization studies have been performed with respect to code benchmarking, RFQ simulation using realistic LEBT output distributions, and an updated CH-DTL design with more detailed inter-tank configurations. This paper summarizes the new results.

the Kilpatrick factor to ≤ 30 kW/m and 1, respectively, for all warm cavities, even shortened the whole layout from 11.4m to 10.6m, and kept the beam dynamics performance satisfying. Being very conservative for CW operation and more cost-saving, this design has been taken as the baseline for further studies [5].

PRELIMINARY DESIGN

Following the EUROTRANS project [1], MAX [2] (MYRRHA Accelerator eXperiment research and development programme) is the ongoing European ADS (Accelerator-Driven System) project. For the front end of the driver linac, the EUROTRANS-style injector [3] that consists of one RFQ (Radio-Frequency Quadrupole), two RT (room-temperature) and four SC (superconducting) CH (Cross-bar H-mode)-DTL (Drift-Tube Linac) cavities will be still adopted, but with many new concepts [4].

The most important idea is to halve the RF frequency from 352MHz to 176MHz, which improves the RFQ shunt impedance significantly (see Fig. 1), enlarges the minimum gap between electrodes, and allows replacing the 4-vane RFQ structure by the simple 4-rod one. Consequently, for keeping the RFQ length at ~ 4 m and the warm part still compact, the RFQ-DTL and RT-SC transition energies are reduced from 3MeV and 5MeV to 1.5MeV and 3.5MeV, respectively, which indeed brings more difficulties to the beam dynamics design but helps improving the RT-CH shunt impedance.

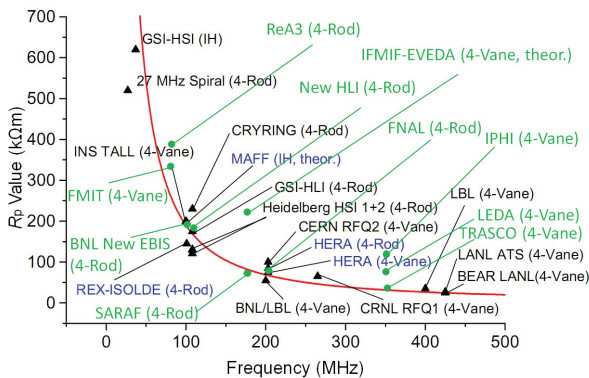

Figure 1: A survey of R_p values for RFQs [5].

From EUROTRANS to MAX, the injector design has lowered the RF power consumption per unit length and

* Funded by the European Atomic Energy Community's (Euratom) 7th Framework Programme under Grant Agreement n°269565.

[#] Chuan Zhang: zhang@iap.uni-frankfurt.de

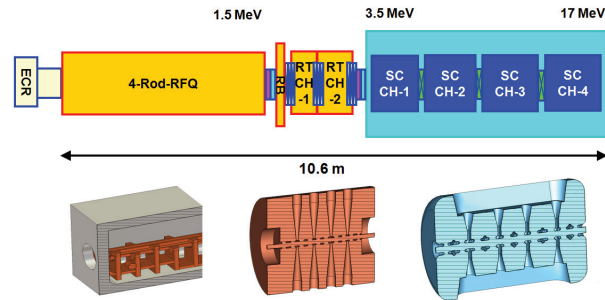

Figure 2: Preliminary layout for the MAX injector.

CODE BENCHMARKING

For the preliminary design of the MAX injector, the ParmteqM [6] and Lorasz [7] codes were used to simulate the beam transport in the RFQ and CH-DTL parts, respectively. Recently, the Toutatis [8] and TraceWin [8] codes have been introduced for benchmarking.

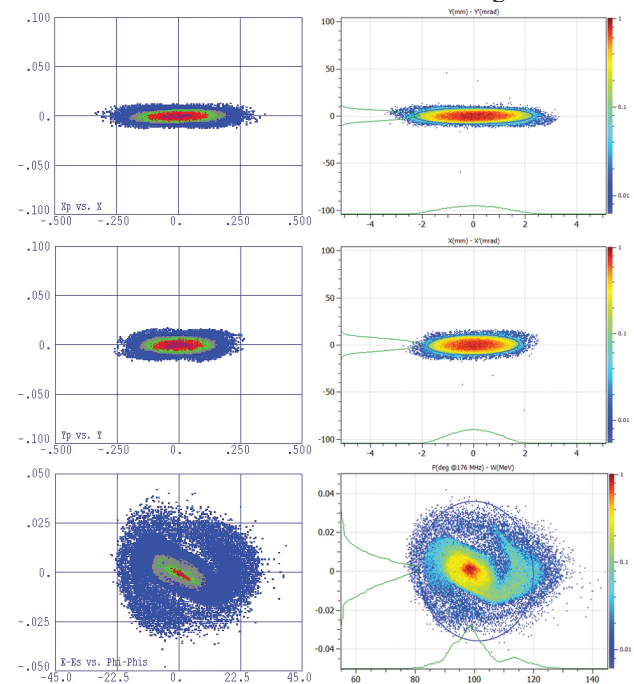

Figure 3: RFQ output particle distributions given by the ParmteqM (L) and Toutatis (R) codes.

Fig. 3 shows the RFQ output beams simulated by the ParmteqM and Toutatis codes. It's clear that the shape,

orientation, and size of the particle distributions are all quite similar on the three planes (the x and y planes are exchanged in Toutatis), respectively. Fig. 4 compares the emittance evolutions along the RFQ. Obviously, all transverse-emittance curves are almost identical, while the longitudinal-emittance ones have a small difference (which might be caused by a few halo particles) after $z=0.5\text{m}$, but they have nearly same evolution shape.

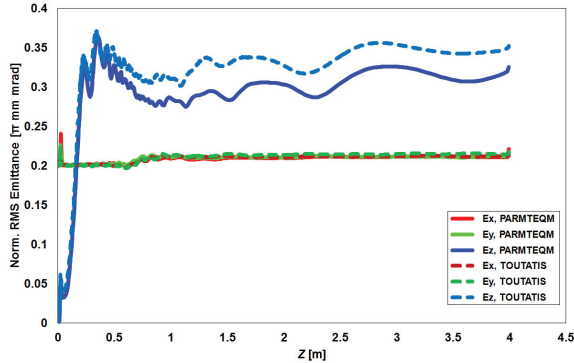

Figure 4: Emittance evolutions along the RFQ.

For the CH-DTL benchmarking, the first CH cavity with the integrated two triplets (see Fig. 5) has been used.

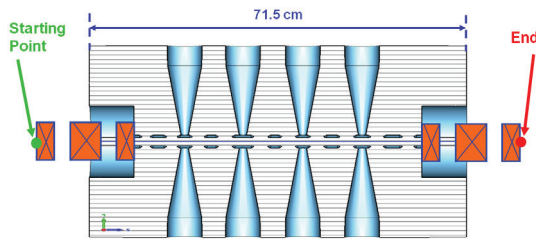

Figure 5: Benchmarking sample from the CH-DTL.

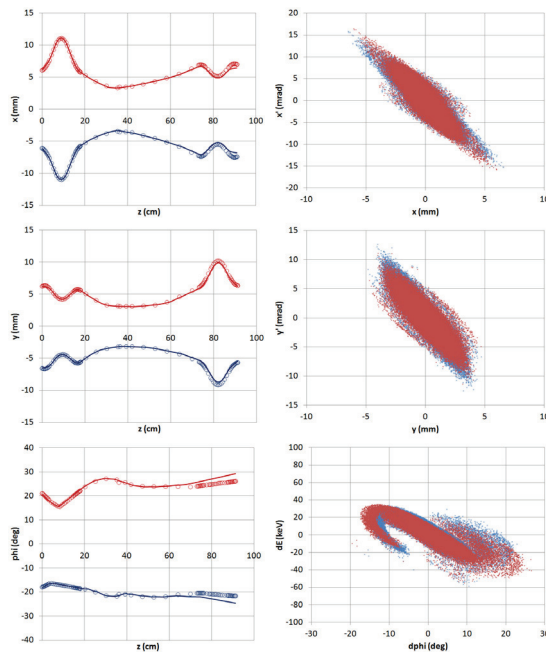

Figure 6: Beam envelopes (L) with circles by Lorasz and curves by TraceWin and output particle distributions (R) with blue dots by Lorasz and red dots by TraceWin.

In Fig. 6, the plots of the CH-DTL beam envelopes and output particle distributions show a good agreement between the Lorasz and TraceWin codes.

RFQ SIMULATION WITH LEBT OUTPUT

The MAX RFQ was designed using the New Four-Section Procedure [9] with a 4D-Waterbag input distribution. Table 1 summarizes the new simulation results based on the output particle distributions from the LEBT (Low Energy Beam Transport) designs [10]. It is seen that no matter the short or long version of LEBT will lead to similar results in the nominal (CW beam) and transient (with chopper) cases. All performance is still satisfying, except the longitudinal emittances have some relatively bigger but still acceptable growths due to the wing-form halo particles (see Fig. 7) from the LEBTs. However, the RFQ output distributions are always clean.

Table 1: LEBT-Based RFQ Simulation Results.

Parameter	Waterbag	Short LEBT		Long LEBT	
		transient	nominal	transient	nominal
$\epsilon_{in}^{t, n, rms}$ [π mm-mrad]	0.20	0.18	0.16	0.14	0.14
$\epsilon_{out}^{x, n, rms}$ [π mm-mrad]	0.22	0.20	0.17	0.17	0.15
$\epsilon_{out}^{y, n, rms}$ [π mm-mrad]	0.22	0.20	0.16	0.17	0.15
$\epsilon_{out}^{l, rms}$ [π keV-deg]	64.6	92.4	92.7	108	80.0
T [%]	100	99	98.5	98.2	98.6

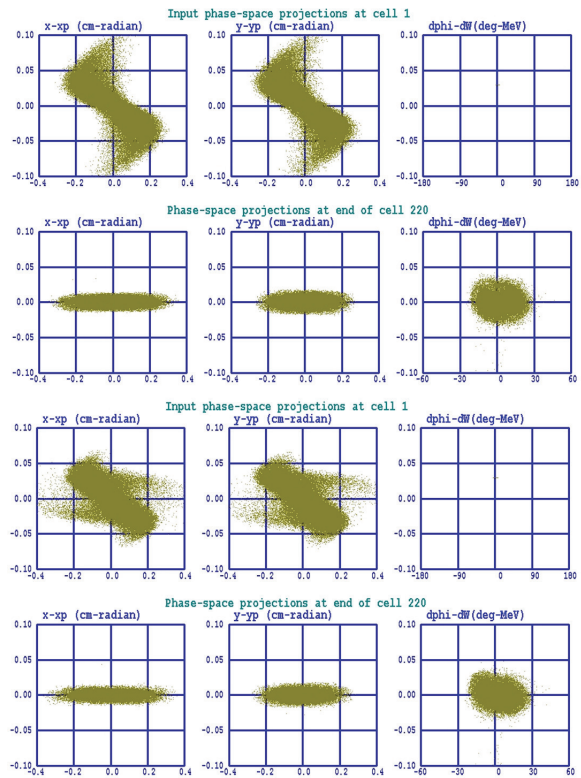

Figure 7: RFQ phase spaces with the short (T) and long LEBTs (B) in the transient case.

NEW MAX INJECTOR DESIGN

In the previous beam dynamics studies, the space needed for the inter-tank components was reserved by estimation. The inter-tank sections have been newly redesigned including all the details, e.g. the bellows for connecting cavities, the magnetic-field shielding for the solenoids, and the real dimensions of the cryomodule. The drift spaces between the cavities become longer, especially at the RFQ-DTL and RT-SC transitions, which increases the difficulty for the beam dynamics design.

The most critical area is the RT-SC transition where the drift space was extended by ~50cm. To overcome the negative consequences in both longitudinal and transverse planes, a new rebunching cavity (so-called RB-2) working at the -90° synchronous phase and a new solenoid have been added in front of the first SC-CH.

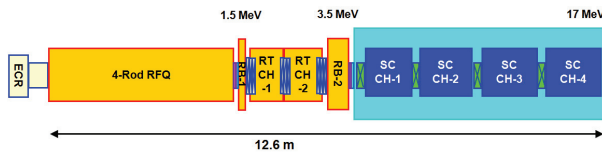

Figure 8: New layout for the MAX injector.

The beam dynamics of the new CH-DTL shown in Fig. 8 was re-optimized by tuning the focusing strength of all lenses and the gap voltages of the rebunching cavities while the design of the CH-cavities was kept almost unchanged.

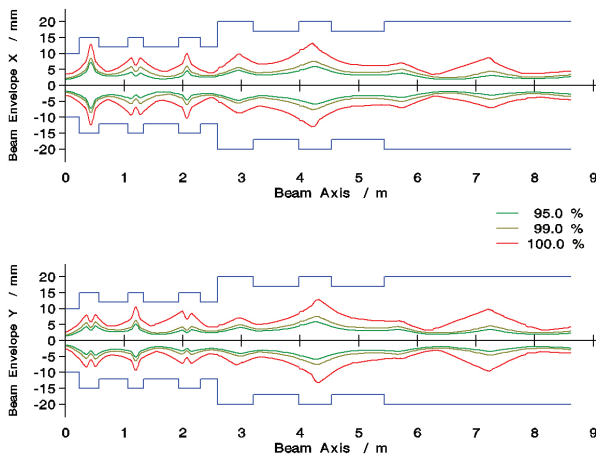

Figure 9: Transverse beam envelopes along the CH-DTL.

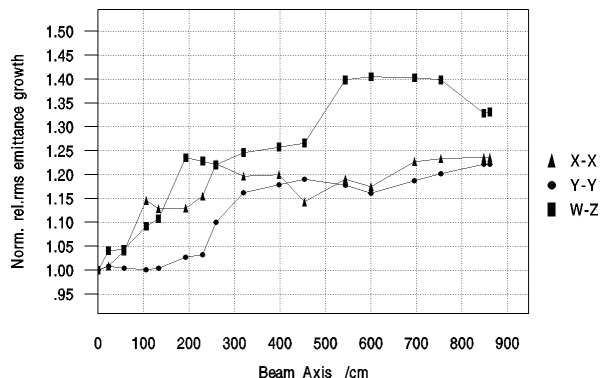

Figure 10: Emittance evolutions along the CH-DTL.

Fig. 9 plots the transverse beam envelopes along the new CH-DTL. In the first triplet, a few beam losses might happen when errors are included, but at 1.5MeV this beam energy they don't play any role. Therefore, a large safety margin is available for the beam throughout the CH-DTL. In addition, the emittance growths are still modest, as shown in Fig. 10.

CONCLUSIONS AND OUTLOOK

The correctness of the simulation results of the MAX injector design was successfully crosschecked by different codes. It was also proven that realistic LEBT output beams accelerated by the MAX RFQ will be transported into the CH-DTL with excellent beam quality. In addition, the simulation of the new CH-DTL updated with detailed inter-tank configurations has shown good performance. To sum up, an advanced new design is now available for the MAX injector. In the next step, systematic error studies will be performed.

ACKNOWLEDGEMENTS

Special thanks go to J.-L. Biarrotte and D. Uriot for their valuable contributions to the benchmarking using the Toutatis and TraceWin codes.

REFERENCES

- [1] <http://nuklear-server.ka.fzk.de/eurotrans/>.
- [2] <http://ipnweb.in2p3.fr/MAX/>.
- [3] C. Zhang, M. Busch, H. Klein, H. Podlech, U. Ratzinger, J.-L. Biarrotte, "Reliability and Current-Adaptability Studies of a 352MHz, 17MeV, Continuous-Wave Injector for an Accelerator-Driven System", Phys. Rev. ST - AB 13, 080101 (2011).
- [4] C. Zhang, H. Klein, D. Mäder, H. Podlech, U. Ratzinger, A. Schempp, R. Tiede, "From EUROTRANS to MAX: New Strategies and Approaches for the Injector Development", Proceedings of the 2nd IPAC in San Sebastian, Spain, September 4-9, 2011.
- [5] C. Zhang, H. Klein, D. Mäder, H. Podlech, U. Ratzinger, A. Schempp, R. Tiede, M. Vossberg, MAX Deliverable 2.1: "352 MHz vs. 176 MHz Injector Comparison & Choice", January 31, 2012.
- [6] K.R. Crandall, LANL Internal Report, Nr. LA-UR-96-1836, Revised December 7, 2005.
- [7] R. Tiede, G. Clemente, H. Podlech, U. Ratzinger, A. Sauer, S. Minaev, "LORASR Code Development", Proceedings of the 10th EPAC in Edinburgh, Scotland, United Kingdom, June 26-30, 2006, pp. 2194-2196.
- [8] <http://irfu.cea.fr/Sacm/logiciels/>.
- [9] C. Zhang, A. Schempp, "Beam Dynamics Studies on a 200mA Proton Radio Frequency Quadrupole Accelerator", Nucl. Instrum. Methods Phys. Res., Sect., A, Volume 586, Issue 2, pp.153-159 (2008).
- [10] J.-L. Biarrotte, "MYRRHA LEBT Preliminary Design Report", July 18, 2011.