

PROJECT X ELLIPTICAL CAVITY STRUCTURAL ANALYSES

E. Zaplatin, FZJ, Jülich, Germany

Abstract

Project X is a proposed at Fermi National Accelerator Laboratory high-intensity proton accelerator complex that could provide beam for a variety of physics projects. Superconducting resonators will be used for beam acceleration.

Here we report a structural design of elliptical cavities with resonance frequency 650 MHz and $\beta=0.91$ and 0.61. Since there is a concern that the pressure in the helium plumbing will not be stable when the cryomodules are connected to the liquid helium supply and helium gas returns it is necessary to provide the cavity stiffening with requirements of 15 Hz amplitude frequency shift. The cavity RF and mechanical properties are investigated. The calculations of the cavity frequency shift with pressure for different schemes of cavity stiffening were provided. The criterion for the optimization was the minimization of a resonant frequency dependence on an external pressure. Based on the results of these simulations several options on cavity stiffening have been proposed. Additionally, the cavity stiffening structural scheme for self-compensation of resonator detuning caused by external pressure fluctuation have been investigated.

INTRODUCTION

Elliptical cavities (650 MHz, $\beta = 0.91$ and 0.61) are under design at Fermi National Accelerator Laboratory [1] for use in a superconducting high-intensity cw accelerator. This paper reports on structural analyses of elliptical cavity for the mid-cell and multi-cell cases. The shift in the resonant RF frequency due to pressure differential was calculated as a function of wall thickness, with and without the helium vessel and stiffening rings. The ANSYS codes [2] were used for the simulations. We assumed the same mechanical properties for the cavity walls and connecting (stiffening) rings (Young modulus = 105000 N/mm² and Poisson ratio $\nu = 0.38$).

PRESSURE RESPONSE OF MID-CELL

The response of the cavity to a pressure differential of 1 bar was simulated (vacuum inside the cavity, ambient pressure outside). The simulations were done with the cell-to-cell junction constrained by symmetry. The goal for these calculations was to understand the behaviour and trends.

The pressure differential changes the cavity shape and shifts the RF frequency of the accelerating mode. Inward deformation near the iris (the region of high electric field) increases the capacitance and hence reduces the frequency. Inward deformation near the equator (high magnetic field region) reduces the inductance and hence increases the frequency. Thus the effects tend to cancel one another. Since the cavity frequency (650 MHz) is

rather low for this cavity type a resonator equator radius is large. It results in large cell slope surface that is strongly affected by an external pressure and the volume change near the iris region is larger than by the equator.

The deformation and frequency shift both depend on thickness of the cavity wall, so the wall thickness was varied in the simulations. We found that the frequency shift is always negative for an unstiffened cavity since the cavity capacitance enhancement prevails cavity inductance reduction.

A stiffening ring can be used to change the frequency shift. Fig.1 shows the middle cell deformations.

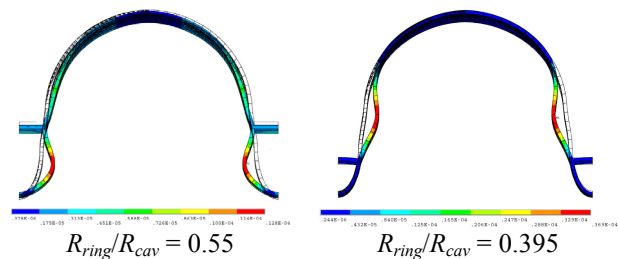

Fig. 1: Mid-cell profile deformations for $\beta=0.91$.

The addition of a stiffening ring affects the frequency shift with pressure. An installation of the stiffening ring can be used as a tool varying the ratio between frequency shift from cavity capacitance and inductance change for substantial df/dp reduction. The ring strengthens the iris region, so by ring/rcav=0.5 the frequency shift is always positive. It means that there is an optimal ring positions (under optimal we understand df/dp minimization) were df/dp should equal zero (for a certain resonator wall thickness). Here for wall=2.8 mm the position of the ring by ring/rcav=0.55 results in $df/dp=0$ (Fig. 2).

Note that, after the cavity is formed and etched, the wall thickness may be significantly different from the initial thickness of the sheet niobium.

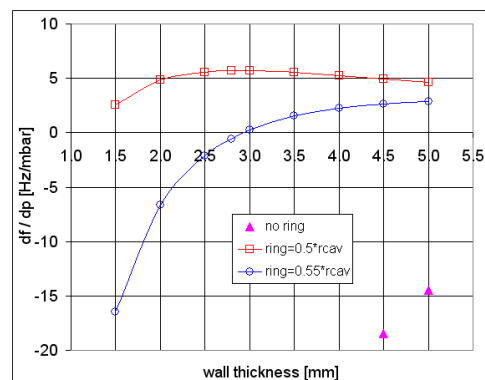

Fig. 2: Mid-cell cavity simulation results.

Changing the ring position (Fig. 3), we see that there are two places for the ring where the frequency shift reaches

zero. Every of them can be used. Still by the higher ring placement (ring/rcav=0.55 rather than ring/rcav=0.395) the maximal cavity wall deformations lower that result in lower mechanical stresses.

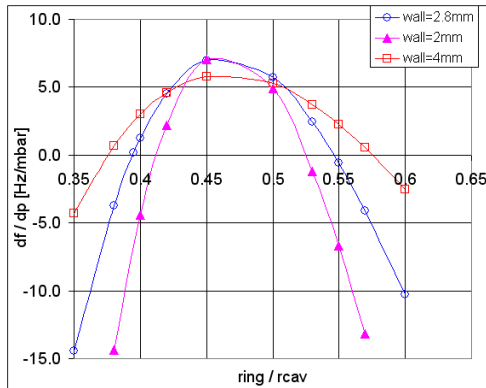

Fig. 3: Mid-cell cavity simulation results.

5-CELL CAVITY WITH HELIUM VESSEL

The simulations for the middle cells give us only a basic understanding of cavity behaviour. A more realistic analysis is that of a multi-cell cavity with beam tubes, end cells (with compensation to ensure field flatness), and a helium vessel.

The simulation model (Fig. 4) consists of 5-cell cavity surrounded by the cylindrical helium vessel. Helium vessel end flanges are connected to the cavity beam pipes. There is a slot in the cylindrical part of the vessel imitating the connection of the coaxial tuner. The stiffening rings are installed between cavity cells and connect end cells with vessel end flanges. The left beam pipe end is completely fixed leaving the right beam pipe end free.

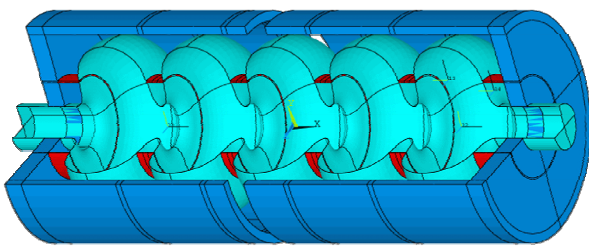

Fig. 4: 5-cell cavity with helium vessel model.

The tune slot edges are also fixed since the tuner stiffness is not taken into account in simulations. Helium vessel flange thickness is supposed 40 mm to avoid their flexibility. The cavity and cryostat are under vacuum and the helium vessel is at 1 bar, the pressure differential is exerted not only on the cavity walls, but also on the inside surfaces of the helium vessel, including end flanges.

Such model configurations result in close conditions of single cell simulations (Figs. 5-6). The helium vessel flanges prevent non-symmetric longitudinal cavity deformation even with asymmetric constrain conditions.

Accelerator Technology

Tech 07: Superconducting RF

For the project cavity wall thickness 2.8 mm there are two df/dp=0 stiffening ring positions.

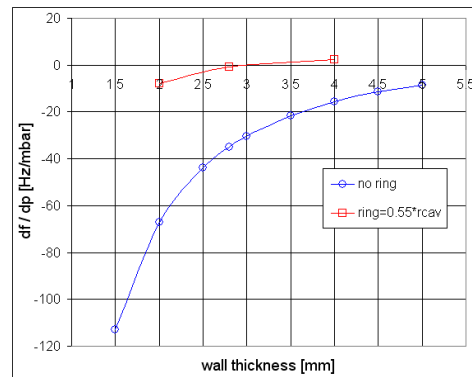

Fig. 5: 5-cell cavity simulation results.

The mechanical stresses are under the limit of 50 MPa.

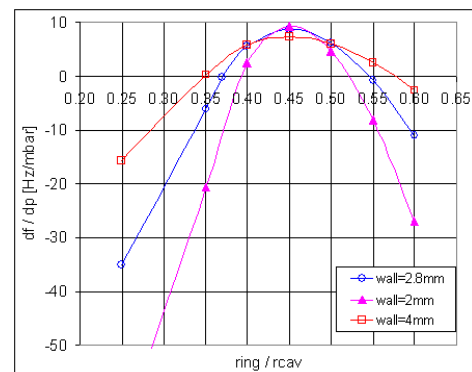

Fig. 6: 5-cell cavity simulation results.

Helium vessel design defines the whole structure stiffness and can be used for df/dp optimisation.

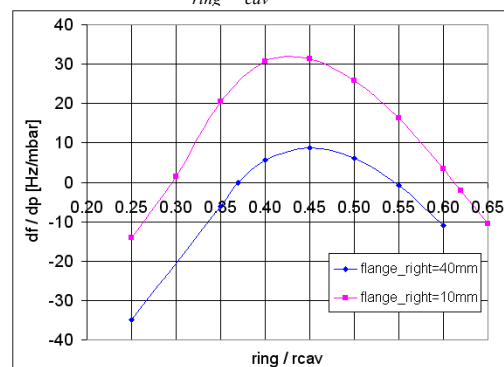
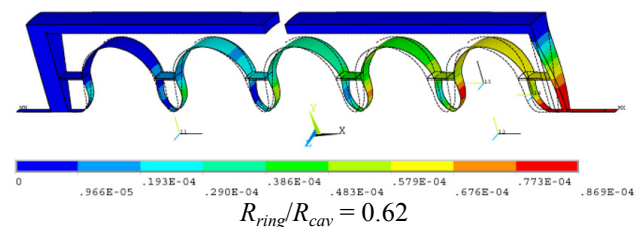

Fig. 7: 5-cell cavity with reduced flange thickness.

One of the possibilities of such optimisation is to vary the vessel flange thickness of the unconstrained beam pipe end. The reduction of the flange thickness results in its deformation enhancements that in its turn results in different cavity ring positions to achieve $df/dp=0$ (Fig. 7).

The reduction of the flange thickness can be made local for the certain radius range (Fig. 8). Dimensions of the region with reduced thickness should be defined together with the whole cavity-vessel design. If to make an initial design with the thickness of this region smaller than it is required for $df/dp=0$, the subsequent bridging of the region with plates of different thickness can provide the final adjustment of the frequency shift. This option can be easily used for subsequent structure adjustment after cavity-vessel fabrication.

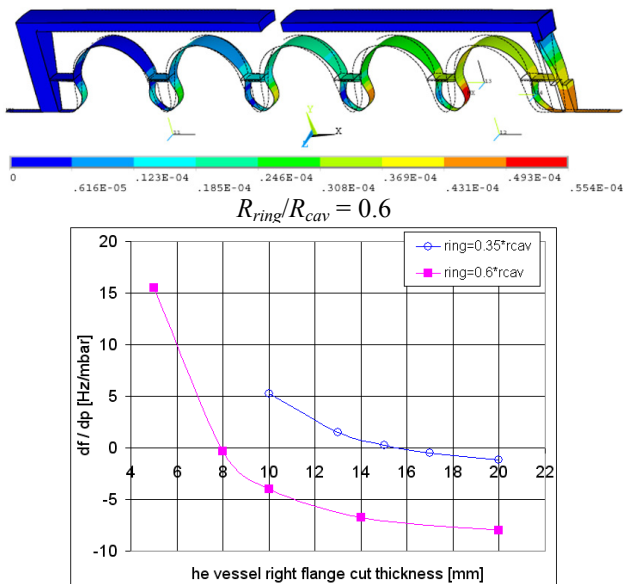

Fig. 8: 5-cell cavity with reduced flange thickness region.

Another option for structure stiffness adjustment is making cut in the helium vessel flange (Fig. 9). Bellows can be included in the helium vessel to accommodate the motion produced by the pressure differential [3].

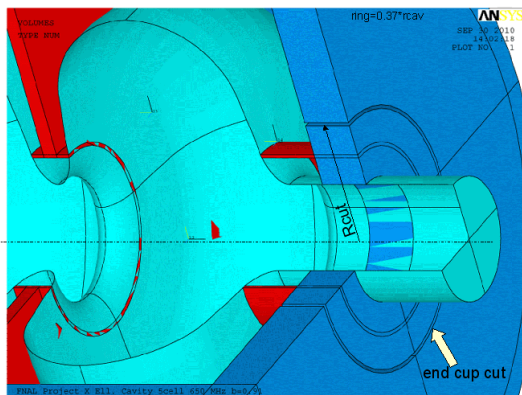

Fig. 9: 5-cell cavity with vessel end flange cut.

One of the dishes is firmly attached to the outer cylinder of the helium vessel; the other is connected via

the bellows. To split tuning (left, Fig. 10) from the compensation (right) parts of the cavity a vertical disk that connects cavity with helium vessel can be installed.

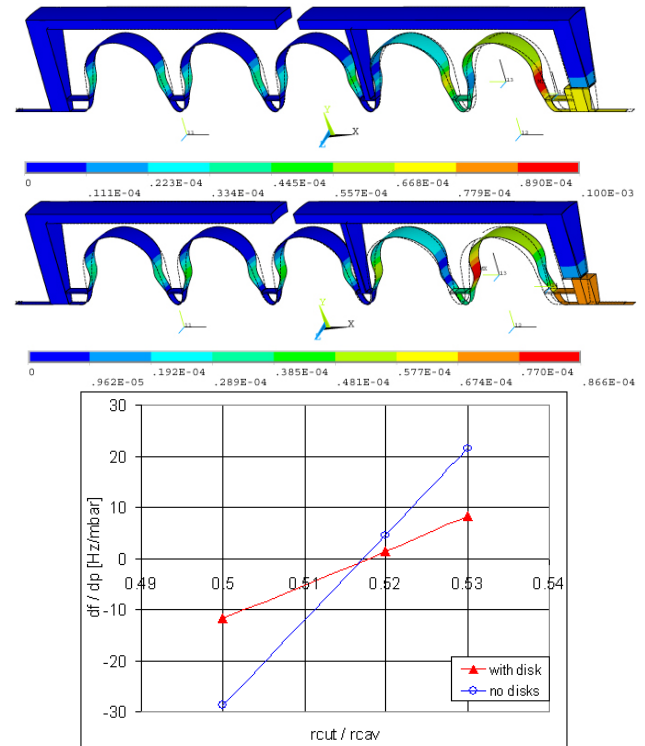

Fig. 10: 5-cell geometries.

Depending on the radius of the cut (Fig. 10), the inward force on the cavity walls will be either larger or smaller than the outward force on the end dish. Thus, the cavity will be either shortened or stretched. There is a particular bellows radius for which the shift in frequency with pressure is zero.

CONCLUSION

Since the only criterion on the optimization of cavity mechanic properties is the shift in frequency due to pressure differential several options of the helium vessel design can provide $df/dp=0$.

REFERENCES

- [1] N. Solyak et al., "The Concept Design of the CW LINAC of the Project X," IPAC'10, Kyoto, Japan, 2010.
- [2] ANSYS, Inc. <http://www.ansys.com/>
- [3] E. Zaplatin et al., "Structural Analysis for a Half-Reentrant Superconducting Cavity," EPAC'06, Edinburgh, UK, 2006.