

SELF-OPTIMIZING HIGH DYNAMIC POWER SUPPLY CONTROL*

Xinhua Ke, Felix Jenni, UAS Northwestern Switzerland, Windisch, Switzerland
 Hans Jaeckle, PSI, Villigen, Switzerland

Abstract

In 1999, the first fully digitally controlled magnet power supplies were put into operation at PSI (Paul Scherrer Institute, Switzerland). Today, approximately 1000 are in use at PSI and a multiple of that worldwide. This project aims at developing a high performance control scheme to improve the dynamic behavior of today's magnet power supplies, without reducing their excellent static behaviors. The resulting control strategy is an observer based state space and proportional integral (SS-PI) control. The observer is modeled via system identification. The control strategy leads to a significantly improved dynamic behavior of the existing power supplies. The whole commissioning, including system identification, as well as control parameter determination and optimization, is done automatically with support of a PC. The control strategy has been implemented and tested on a second generation Digital Power Electronic Control System (DPC) controller card and a corrector power supply, together with various magnets.

INTRODUCTION

Since 1999, fully digitally controlled magnet power supplies, as shown in Figure 1, are in use in accelerators at PSI as well as worldwide. The static performance, including precision and stability, has reached a very high level [1].

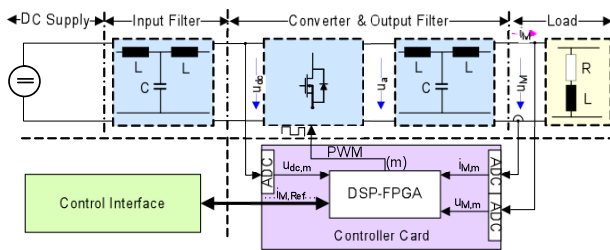

Figure 1: Digitally controlled magnet power supplies.

The SOPS (Self-Optimizing Power Supplies) project was launched in 2008 at PSI. The goal was to develop a high performance control structure, pushing forward the dynamic behavior of today's magnet power supplies, without reducing its already-reached static performances. An observer and in situ identification based high dynamic control strategy was developed [2]. The new control structure can also be implemented on the existing power supply and control hardware without any hardware changes. The whole commissioning of the power supplies can be done automatically and in situ.

FEATURES OF THE CONTROL STRATEGY

The control structure is shown in Figure 2. The inner loop makes use of all the internal states of the output filter, to reach an optimum dynamic behavior of the magnet voltage. State feedback allows higher loop amplification, which helps improving the suppression of the disturbances. The outer loop is basically a standard PI-controller for a precise magnet current. Advanced anti-windup for the PI-controller is implemented to guarantee a very good large signal behavior.

The observer is obtained by means of a subspace based system identification, using the measured DC-link voltage $u_{dc,m}$, magnet voltage $u_{M,m}$ and magnet current $i_{M,m}$ [3]. The control parameters are determined and optimized automatically from the frequency response of the identified observers.

Current Prediction

Current prediction is implemented to compensate the system-inherent delay and noise filtering low pass filter. The signal $i_{M,m,obsv,fb}$, used for the feedback has the static behavior of the measured magnet current $i_{M,m}$ and the dynamic performance of the observer current $i_{M,obsv}$. The low pass filter compensation gives a fast feedback signal without suffering from noise.

Reference Current Limiter

The reference current limiter allows an unlimited path for small signals. The controller makes full use of the dynamic margin of the power supply to make unlimited steps. This is used for small amplitude fast current regulation. A second signal path allows the magnet current to ramp up and down with the maximum di/dt the hardware allows. This is intended to be used in large amplitude regulations.

Filter Protection

Last but not least, the filter protection is made by evaluating the dissipated power in the damping resistors from the measured magnet voltage.

ACHIEVED DYNAMIC PERFORMANCE

The presented control strategy has been implemented and tested on the Digital Power Electronic Control System (DPC) [4], controlling a 12V/10A corrector power supply and a 5A corrector magnet. The controller works with 10us control cycle time. The following measurements show the achieved dynamic performance. The reference current $i_{M,Ref}^1$, the magnet current $i_{M,m}^{1,2}$ and the magnet voltage $u_{M,m}^{1,2}$ are displayed.

*Work supported by the Paul Scherrer Institute (PSI), Switzerland.
 # rene.kuenzi@psi.ch

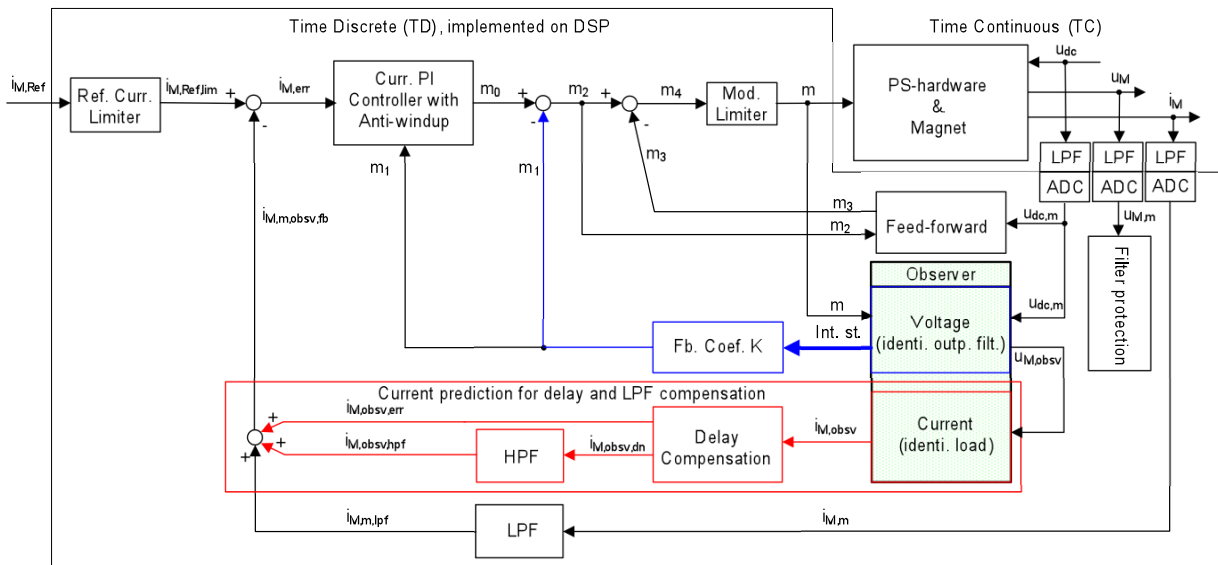

Figure 2: Functional diagram of the observer based control structure.

Small Signal Step Response

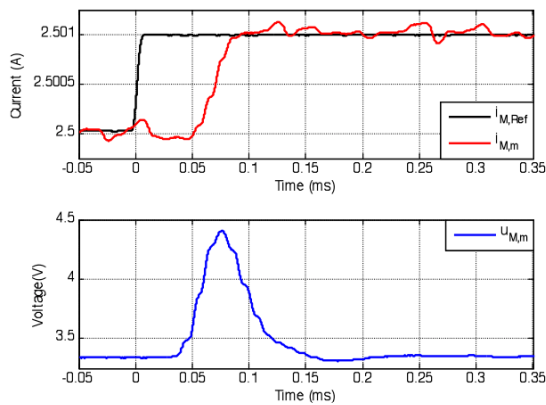

Figure 3: Unlimited step at 2.5A.

Medium Signal Step Response

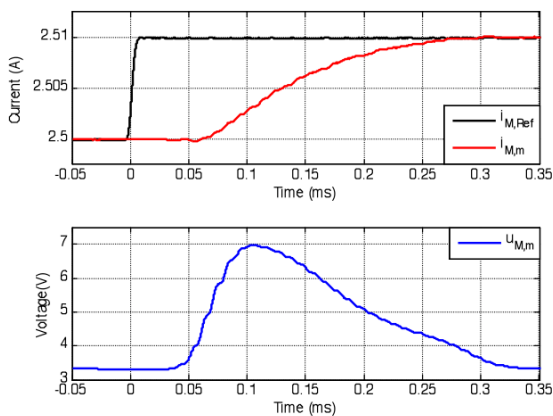

Figure 4: 10 times the unlimited step at 2.5A.

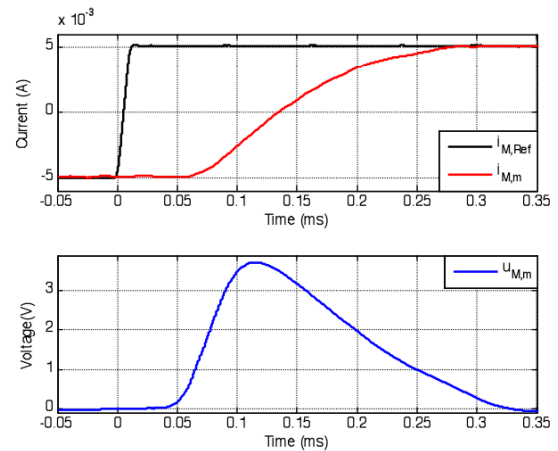

Figure 5: 10 times the unlimited step size, crossing 0A.

Large Signal Step Response

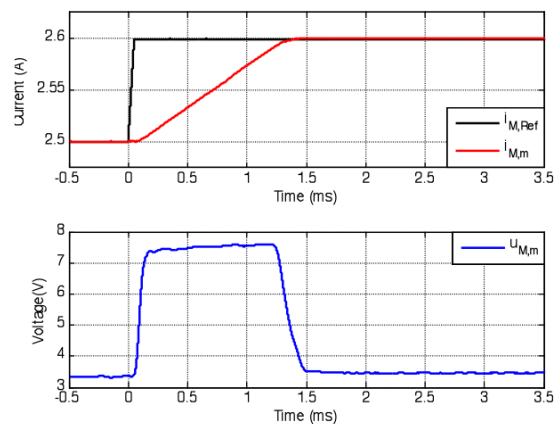

Figure 6: 100 times the unlimited step size at 2.5A.

Copyright © 2011 by PAC'11 OC/IEEE — cc Creative Commons Attribution 3.0 (CC BY 3.0)

Full Scale Step Response

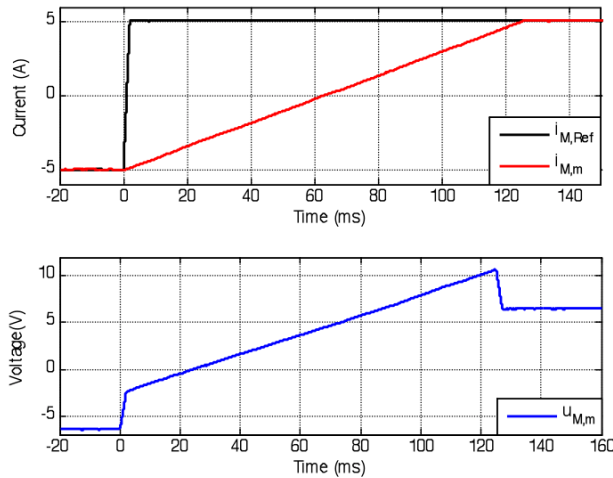

Figure 7: Full scale -5A to 5A.

BENEFITS FOR THE USER

From the user's points of view, the operation of the power supplies is identical as it is today. What is needed is the installation and a run of the developed power supply configuration tool before the operation starts.

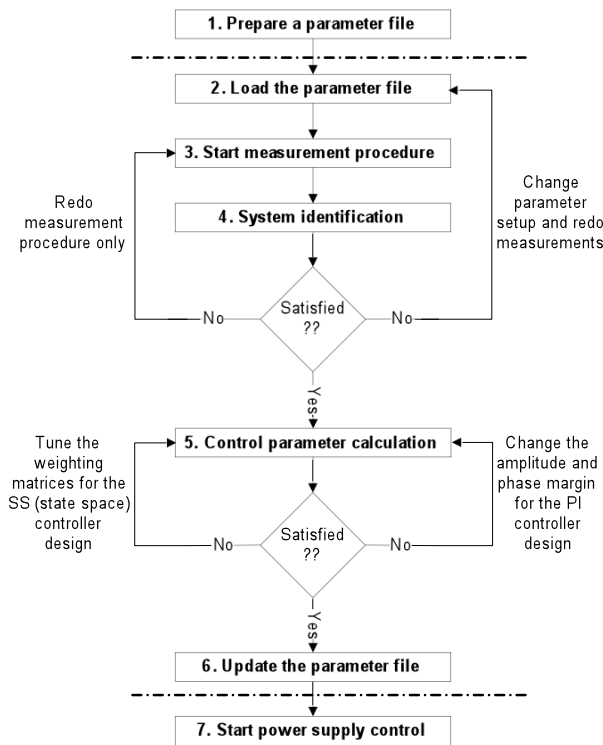

Figure 8: SOPS operation procedure.

The operation procedure of SOPS is shown in Figure 8. A parameter file is created for the system identification measurement, which contains the general information of the power supply. The identification measurement procedure provides a data file with the three measured properties used for system identification: the DC-link

voltage, magnet voltage and magnet current. At the end of the system identification and control calculation process, the information of the observer model and the control parameters will be written back to the parameter file. With this parameter filter, the user can start the power supply control as it is today. All the operations are done automatically with the support of a PC.

For the user the following results:

- The control brings always the maximum dynamic performance out of the existing hardware. It is a 'must' for fast applications.
- Independent of the control structure used, the system identification can be applied to get a precise description of the system to be controlled.
- If the state of the art PI control is used, the state feedback for the inner loop can be skipped and only the control parameters for a PI controller will be determined and optimized automatically.
- The identification is done in situ on the final setup of the power supply system, without any hardware changes.
- This control strategy can easily be integrated into the existing control hardware with software update only.

CONCLUSIONS

The presented control strategy obtains an exact system description via in situ system identification. This gives the possibility for an automatic controller design. The optimized two loop SS-PI control structure leads to a significantly improved dynamic behavior of the existing magnet power supplies. Together with the PSI new Digital Power Electronic Control System (DPC), the SOPS power supplies might become a new benchmark for digital power supply control.

REFERENCES

- [1] F. Jenni, R. Künzi, A. Lüdeke and L. Tanner, "Five years of operational experience with digitally controlled power supplies for beam control at the Paul Scherrer Institute (PSI)", in EPEC 2005 European Power Electronics Conference, 2005.
- [2] X.h. Ke, F. Jenni and H. Jaeckle, "Observer and In Situ Identification Based High Dynamic Converter Control", in PCIM 2011 Europe Power Electronics Intelligent Motion Power Quality, Nurnberg, 2011.
- [3] X.h. Ke, F. Jenni, "In situ System Identification for an Optimal Control of Magnet Power Supplies", in PAC'11 Particle Accelerator Conference 2011, New York, 2011.
- [4] M. Emmenegger, H. Jäckle, R. Künzi and S. Richner, "A new generation of digital power supply controllers", in IPAC'10 International Particle Accelerator Conference, 2010, pp. 3263-3265.

¹ Digital signals from the DSP are displayed on an oscilloscope via a 'Scopebox'.

² The signal is measured from the physical system via ADCs; hence it contains the whole measurement path delay.