

AGS TUNE JUMP POWER SUPPLY DESIGN AND TEST*

J. Mi[#], J. W. Glenn, P. J. Rosas, H. Huang, I. Marneris, J. Sandberg, Y. Tan, W. Zhang,
BNL, Upton NY 11973, U.S.A.

Abstract

A horizontal tune jump system, consisting of two quadrupole magnets, was been installed at the AGS ring to overcome the intrinsic spin-resonances that require jumping the horizontal tune by 0.04 units 82 times, i.e., 41 up and 41 down. The pulsed magnet current ranges from about 140A near injection, rising later to about 1400A. The time of both the rise and fall in the current's pulse is around 100uS, and flat top time persists about 4mS. These quadrupoles have separate power supplies. This tune jump pulse power supply employees all semiconductor parts as well as the main switches. During dummy load and magnet testing, the results showed that the power supply met the specifications. This article details and illustrates the power supply, and discusses our design, simulation, and testing, illustrating some test waveforms.

INTRODUCTION

To increase the AGS beam's polarization, an upgrade project was conducted. The project included installing two tune jump magnets and two individual pulse power supplies. The two magnets (Fig. 1) were placed in the



Figure 1: Tune jump magnet in the AGS tunnel.

AGS ring's I5 and J5 areas. According to the physics requirement, the pulse power supply's output will deliver a current pulse train to jump the horizontal tune 82 times during the acceleration of polarized protons in the AGS. The power supply specifications are as follows:

Magnet peak current	1400A
Current change range	140~1400A
Magnet inductance	~40uH

* Work supported by Brookhaven Science Associates, LLC under Contract No. DE-AC02-98CH10886 with the U.S. Dept of Energy
[#]mi@bnl.gov

Load resistance	~28m Ohm
Pulse rise time	100uS
Pulse flat top time	4mS
Pulse fall time	~100uS
Pulse train number	40

PRINCIPLES OF THE CIRCUIT AND ITS SIMULATION

Figure 2 depicts the circuit principle of the AGS's tune jump power supply. The energy, in the charged capacitor C1, first is discharged through the switch, SW1, to the inductor load, Lo. When the current rises up in half-sine wave to the top of the half sine wave, then switch SW2 is turned on. The source of the load current is transferred from C1 to an LV PS. After about 4mS, SW2 is turned

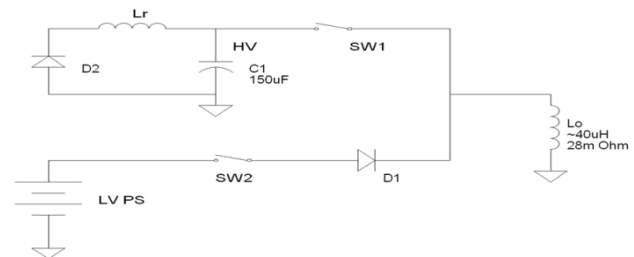

Figure 2: The tune jump power supply circuit principle.

off, and the load current is switched back to the LC circuit, continuing the decline of the half sine wave. Indeed, this scheme of the power supply might be considered as the combination of two power supplies; one is an LC half sine wave discharging pulse power, whilst the other is a DC power supply. The half sine wave pulse has two parts, viz., a rise period, and a fall period. After the half sine wave current reaches its peak, the current is switched to the DC power supply. This power supply maintains the pulse flat top until the current is transferred back to the half sine wave pulse. Lr and D2 constitute a flywheel circuit.

Figure 3 shows the result of our simulation of a waveform wherein the current waveform is shown in

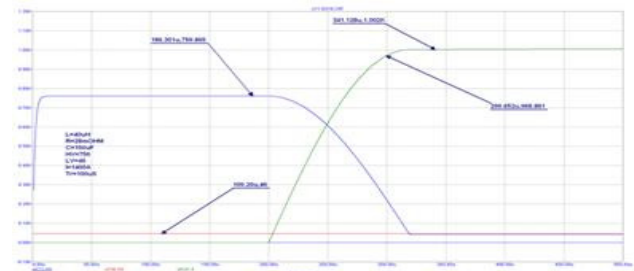

Figure 3: AGS tune jump power supply simulation.

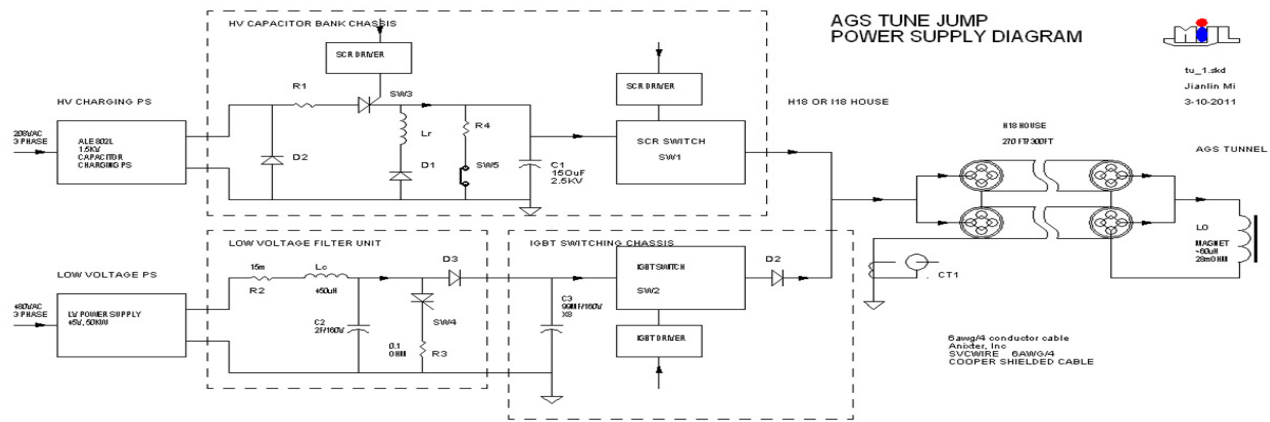

Figure 4: Diagram of the AGS tune jump power supply.

green, and the voltage waveform is depicted in blue. According to the 40uH load inductance, we selected a 150uF capacitor to construct the LC circuit. The load current is 1400A, and the capacitor's charging voltage is 756V. The low voltage power supply's output is around 46V, depending the load resistance, 28m Ohm. The pulse rise time is about 100uS.

POWER SUPPLY DESIGN, ASSEMBLY AND INSTALLATION

Two tune jump power supplies drive the I5 and J5 tune jump magnets. Each power supply, mainly, consists of three parts; a high voltage capacitor bank chassis, an IGBT switching chassis, and a low voltage filter unit. A 45V 50kW low voltage power supply charges the low voltage capacitor bank, C3 through the low voltage filter unit. We use a 1.5kV ALE 802L capacitor changing power supply to charge the high voltage capacitor C1. An IGBT chassis switches the pulse's current from rise time to the pulse's current flat top time, and from flat top to fall time. Fig.4 illustrated the details of these interconnections.

High Voltage Capacitor Bank Chassis

Three 50uF, 3.5kV high voltage capacitors connected in parallel are installed in the HV cap bank obtained from General Atomics Electronic Systems, Inc. The HV discharging switch used is a Powerex LS43_50 SCR.

IGBT Switching Chassis

Our current One IGBT made by ABB is used as the current switch unit. The IGBT Module number 5SNA 1600N170100 rated at 1600A 1700V. We used a CONCEPT ISD536F2 as the IGBT's driver. A fiber optical cable connected to control the IGBT on and off. Figure 5 shows the IGBT and the diode assembly with its heat sink, the IGBT driver, and a silicon controlled rectifier? (SCR). A simple snubber circuit was used for protection.

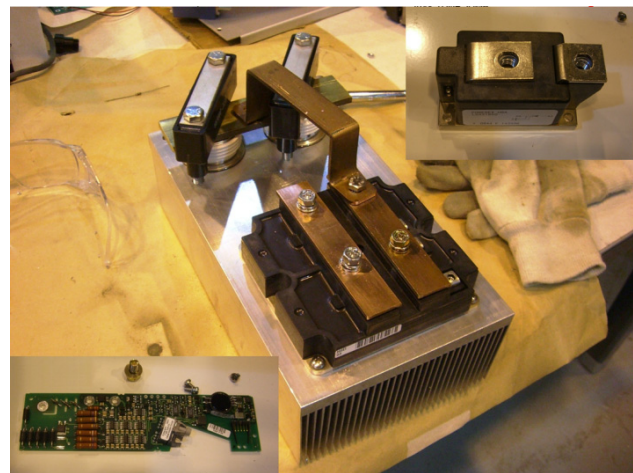

Figure 5: Power IGBT, SCR, diodes and IGBT driver.

Low Voltage Filter Unit

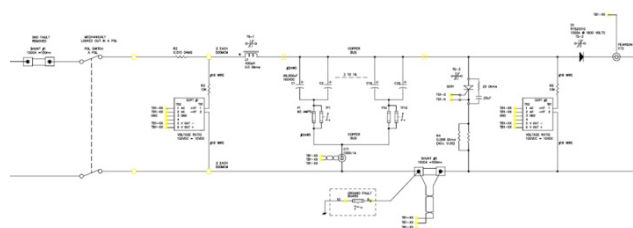

Figure 6: Low voltage filter unit circuit.

This filter unit mainly consists of a low voltage capacitor bank, 2.0F, and a 450uH inductor. A SCR and a 0.1ohm resistor discharging circuit discharge the 2F capacitor's energy after the last pulse, as the amplitude of the 40 pulse increases from 140 to 1400 almost linearly. This heavy filtering of the LV system reduces the peak current of this supply.



Figure 7: A complete tune jump power supply.

Power Supply Control Rack and PLC Unit

An AB[®] programmable logic controller (PLC) unit controls this power supply. All the power supply's control boards are installed in a 3U Euro card chassis. PSI implements timing control and reference remote control, allowing the power supply to be modulated remotely through the AGS's pet control page. The accelerator function generator sets the pulse timing. A local timing-interlock circuit protects the power supply from a fault in the control time trigger. Meanwhile, software protection is used for setting the maximum high voltage and low voltage. Fig.7 shows the completed system installed and ready for operation; it encompasses a control rack, a low voltage power supply, a high voltage capacitor bank, and the IGBT switching chassis. A new interlock called "Cap Bank Overvoltage" checks the output voltage of the low voltage cap bank, so that it does not exceed a certain level. The capacitor bank's output voltage ratio is $100V=10V$ and the interlock is set to 5.5V, which equals a 55 volt output. When the voltage level reaches this value on the analogy card, a comparator circuits trips the interlock, sending a signal to the PLC to trip the Tune Jump power supply.

POWER SUPPLY TEST AND OPERATION WAVEFORMS

Before installing the power supply system into the machine, we tested it with a dummy load, then with the magnet load, and finally, the real two tune jump magnet loads. The tests were completed in two phases; Long time high power tests, and real pulse function tests. Assessing the waveform verified that the rise time and the fall time meet the specifications. The amplitude of the peak current reached to 1500A. Figure 8 plots the waveforms of this rise and fall against time.

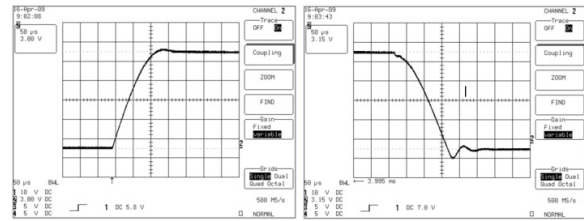

Figure 8: Dummy load test waveform, current peak 1500A, and time 50uS/div.

Figure 9 illustrates the operational current and the waveform of the AGS's tune-jump power supply. The current amplitude ranges from 1400A to a peak of 1400A. Currently, two tune jump power supplies are commissioned in accelerator operation. Both operate well and reliably.

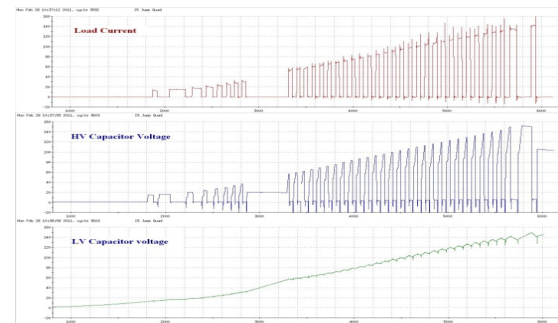

Figure 9: Operational waveform of the AGS's tune-jump power supply.

CONCLUSIONS

Two AGS tune jump power supplies were installed in AGS facility in a relatively short period of R&D and assembly, (around half year). The system, along with other updated units of the machines, operates well and assures good beam polarization (higher than 70%) in the AGS.

ACKNOWLEDGMENTS

The authors would like to thank all CA department personnel who helped and supported us in this project. . We are grateful especially to K. Hartman did outstanding work in assembling, installing, and testing this system. The efforts of J. Addressi, S. Perlstein, F. Dusek, G. Hubbard, and J. Sanfilippo contributed greatly to our success. R. Zapasek skilfully managed manpower and procurement for this project.

REFERENCES

- [1] J. W. Glenn and et al., "AGS Fast Spin Resonance Jump, Magnets and Power Supplies," PAC2009, p. 1699 (2010); www.JACoW.org.
- [2] J. W. Glenn and et al., "AGS Tune Jump System to Cross Horizontal Depolarization Resonances Overview," these proceedings.