

TIME RESOLVED MEASUREMENT OF ELECTRON CLOUDS AT CESR TA USING SHIELDED PICKUPS*

J.P. Sikora[#], M.G. Billing, J.A. Crittenden, Y. Li, M.A. Palmer, CLASSE, Ithaca, New York
 S. DeSantis, LBNL, Berkeley, California

Abstract

The Cornell Electron Storage Ring has been reconfigured as a test accelerator (CesrTA). Shielded pickups have been installed at three locations in CesrTA for the purpose of studying time resolved electron cloud build-up and decay. The pickup design provides electromagnetic shielding from the beam wakefield while allowing cloud electrons in the vacuum space to enter the detector. This paper describes the hardware configuration and capabilities of these detectors at CesrTA, presents examples of measurements, and outlines the interpretation of detector signals with regard to electron clouds. Useful features include time-of-flight measurements of cloud electrons and the use of a solenoidal field for energy measurements of photoelectrons. Measurement techniques include the use of two bunches spaced in multiples of 4 ns, where the second bunch samples the cloud produced by the first bunch.

HARDWARE DESCRIPTION

Vacuum Chamber

Several chambers have been constructed with various vacuum surfaces: bare aluminum, amorphous-carbon and TiN, so that their electron cloud growth/decay can be measured and compared [1,2].

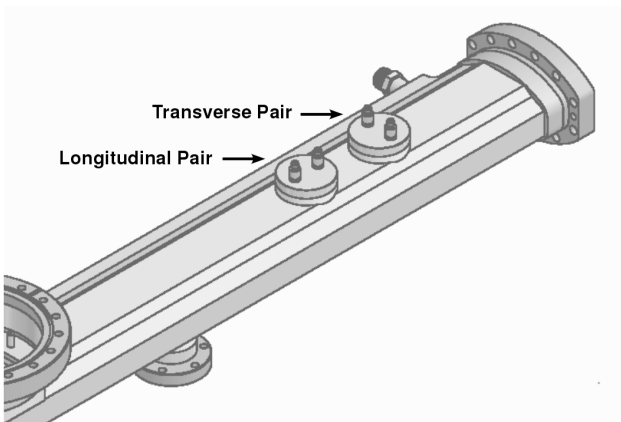

Figure 1: Shielded pickups are assembled in pairs. The longitudinal pair provide redundant measurement of the cloud along the beampipe centerline.

The upper beampipe wall is perforated with small diameter vertical holes and a button assembly welded on top. So although the buttons are in the vacuum space, they are electromagnetically isolated from the main beampipe by the perforated beampipe wall [3] (see Fig.2). The hole geometry favors the detection of electrons with nearly vertical trajectories. All measurements discussed below use a center button, with the beam directly underneath and a button bias of +50 V.

Signal Routing and Electronics

The buttons are typically biased with about +50 V in order to minimize the emission of secondary electrons. The bias is provided through a 10k ohm resistor mounted at the vacuum feedthrough. The voltage induced on the button by the cloud charge is AC coupled via a 0.1 microfarad capacitor to a coaxial cable as shown in Fig. 2. A nearby coaxial relay selects the button signal that is to be routed to two Mini-Circuits ZFL-500 amplifiers having a bandwidth of 0.05 to 500MHz and connected in series for a total voltage gain of 100. The amplifiers are at the input of an Agilent 6054A (500MHz) digital oscilloscope that uses a system timing trigger for signal averaging.

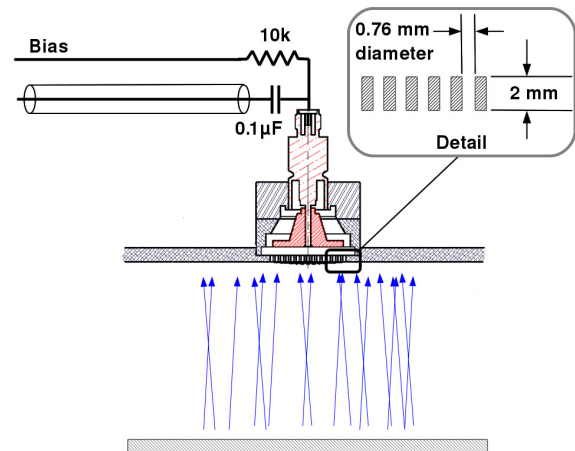

Figure 2: Photoelectrons pass through the holes in the beampipe and enter the evacuated detector volume.

This is probably the simplest possible hardware configuration [4], which was chosen to provide reliable signals for long-term comparisons of the different chamber coatings.

Low field solenoids had been installed in CesrTA that were originally intended as a mitigation technique [5]. In the region of the shielded pickups, bipolar power supplies have been connected to these solenoids so that they can produce approximately +/-40 Gauss fields. These solenoids have been used in estimating the energy spectrum of primary electrons.

DATA EXAMPLES

The observed shielded pickup signal is proportional to the number of electrons entering the detector, not to the electron cloud itself. In the examples that follow, this distinction will become obvious as some of the signal features are described. The important effects of space charge and beam kick of primary electrons will not be discussed, but more details are given by Crittenden in [6].

*This work is supported by the US National Science Foundation PHY-0734867, and the US Department of Energy DE-FC02-08ER41538.

[#]jps13@cornell.edu

Two Bunch Data

The electron cloud is initiated by synchrotron light that generates photoelectrons. These photoelectrons then hit the beampipe walls, and can produce secondary electrons. All of the electrons are absorbed on a time scale of hundreds of nanoseconds.

The data shown in Fig. 3 was taken with two bunches of equal positron currents, 36ns apart. With a ring revolution period of 2.5 microseconds, the cloud has presumably fully decayed by the time of the arrival of the first bunch. This first bunch produces a fairly small signal in the detector. The signal from the second bunch is much larger, not because it has produced more photoelectrons, but because its electric field kicks electrons that were produced by the first bunch into the detector.

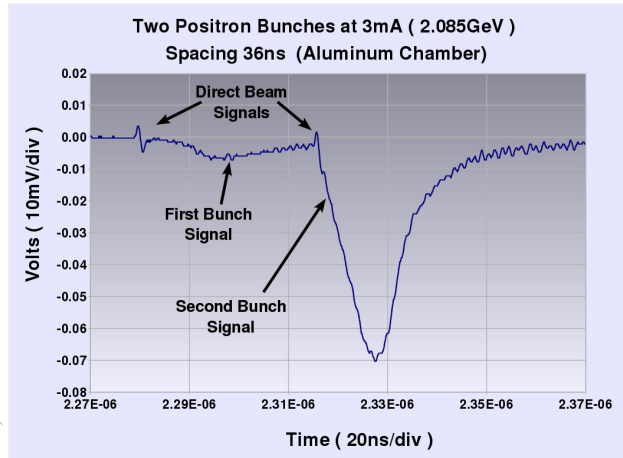

Figure 3: Shielded pickup signal from two bunches of positrons spaced at 36ns

Another feature of the plot in Fig. 3 is the presence of what is presumed to be a small direct beam signal. The geometry of the detector holes give reasonably good – but not complete – isolation from the electromagnetic field of the beam. This signal provides a convenient fiducial that can be used to measure the time-of-flight of cloud electrons.

For example, notice that the peak of the signal from the first bunch occurs about 15ns after its direct beam signal. Most of these electrons must be coming from the floor of the beampipe – a distance of 5cm – which would require an energy of roughly 30eV.

After the passage of the second bunch in Fig. 3, the electrons enter the detector almost immediately. Since this is a positron beam, the electrons kicked into the detector must come from below the beam height in the chamber, at least 2.5cm from the detector. These initial electrons must have energies of many hundreds of eV and originate close to the beam.

Two Bunches with Different Spacings

The much larger signal after the passage of the second bunch suggests that this signal is dominated by cloud electrons that are already in the pipe and are being kicked into the detector. This kick has an effective duration that is set by the sum of the length of the bunch and the size of the button, about 120ps. So the second bunch signal is effectively a sample of the electron cloud in the chamber at the time of the second bunch's transit. Following this idea, pairs of bunches with equal currents were injected with different spacings. The result was a mapping of the electron cloud density produced by the first bunch as a

function of time as the second bunch samples the cloud. In Fig. 5, a number of these measurements are plotted on the same time scale, showing the decay of the cloud.

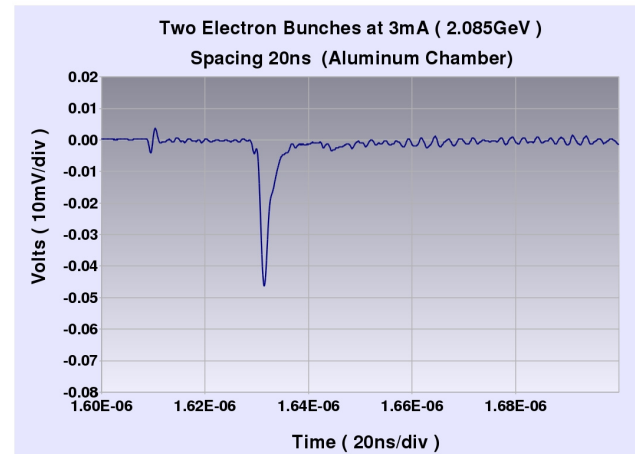

Figure 4: In the signal from two bunches of electrons spaced at 20ns, notice that the signal from the first bunch is not visible (except for the direct beam signal) and that the signal from the second bunch has a faster rise time than that of a positron beam.

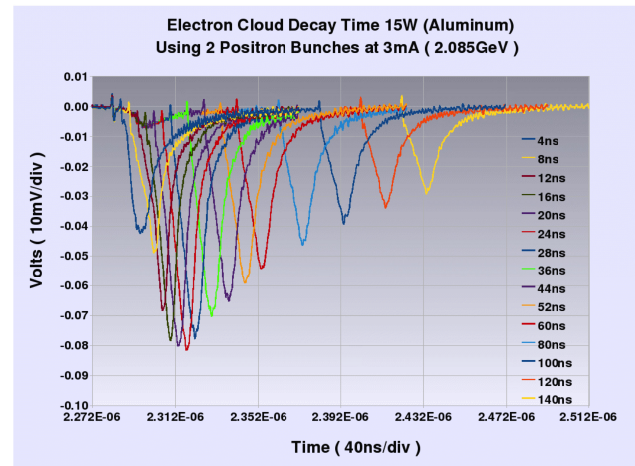

Figure 5: Overlay of two bunch data with spacings in multiples of 4ns at 2.1GeV with an aluminum chamber

Single Bunch with Solenoid

When the solenoid surrounding the shielded pickup is energized, there is a noticeable effect on the detector signal that generally depends on the sign of the magnetic field. In some of the data, there is a significant signal when the sign of the magnetic field is such that primary electrons produced at the outside wall are directed upward into the detector as show in Fig. 6. It is likely that this is due to the synchrotron light stripe in the mid-plane of the beampipe producing a concentration of photoelectrons along that stripe.

Fig. 8 illustrates this interpretation. The magnetic field that gives the largest signal, -14 Gauss, can be used to estimate the electron energy, ~150eV. At the same magnetic field, Fig. 7 shows the time-of-flight of these electrons to be about 8ns. The trajectory has a length of about 6.25cm, giving an energy of ~170eV as calculated by time-of-flight.

Copyright © 2011 by PAC'11 OC/IEEE — cc Creative Commons Attribution 3.0 (CC BY 3.0)

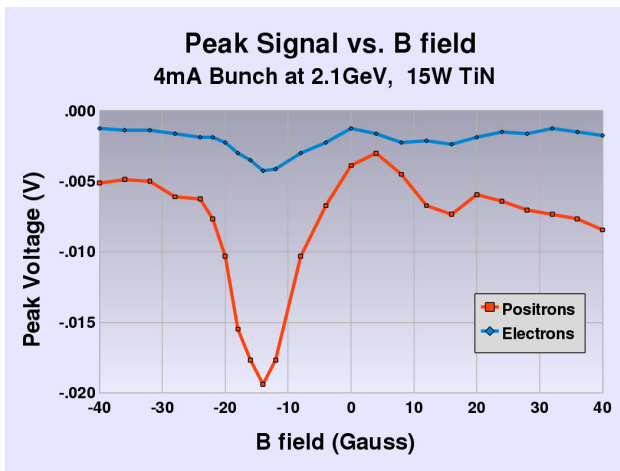

Figure 6: Pickup signal variation with solenoid field.

So when used with a solenoid, the pickup can function as a crude spectrometer. However, because the buttons are relatively large, the energy resolution is poor.

Also notice in Fig. 7 that the zero field signal arrives later – with electrons coming from the bottom of the beampipe 5cm distant. This gives an energy of only ~48eV by time-of-flight. The apparent energy difference between electrons coming from the bottom and from the outside wall of the beampipe needs to be understood, as well as other inconsistencies in data interpretation.

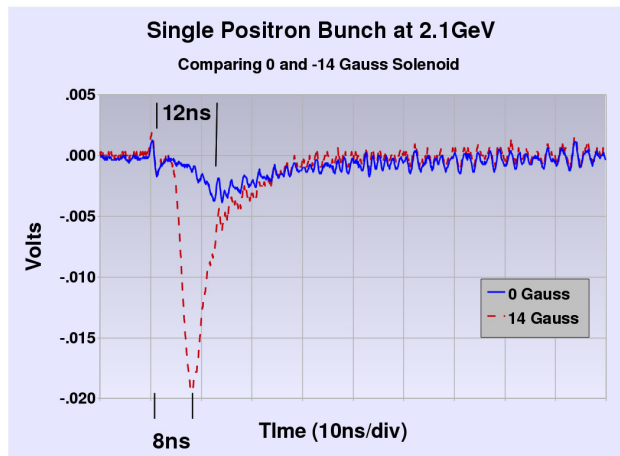

Figure 7: Above are plots of the observed signals with the solenoid at zero and at -14 Gauss.

FUTURE WORK

Systematic data collection began in March 2010. Essential information is being loaded into a database that

should allow researchers to find, for example, data from 20 bunch trains of positrons with 14ns spacing and a beam energy of 4GeV, in a carbon coated chamber, etc.

Much of the remaining task begins with carefully interpreting data that has already been taken, as well as extensive modeling of both the electron cloud and the detector. We are planning studies where the horizontal position of the beam is changed underneath the detector, as a check on detector acceptance modeling. We also need to characterize a diamond-like carbon coated chamber that was installed in January 2011. In the summer of 2011 we plan to install an additional set of four detectors mounted azimuthally on a round beampipe.

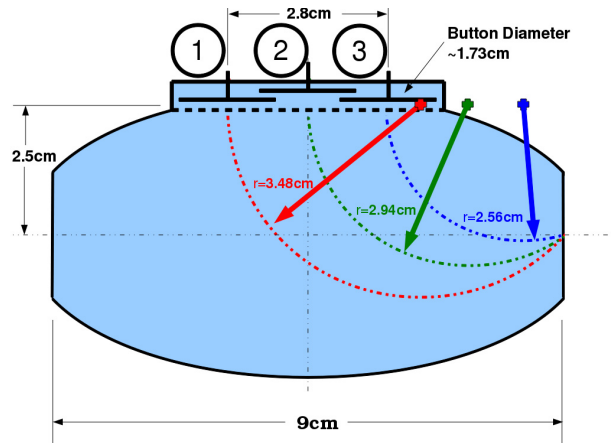

Figure 8: Detector geometry with solenoid energized

REFERENCES

- [1] M. Palmer, et al. “The Conversion and Operations of the Cornell Electron Storage Ring As a Test Accelerator (CESR-TA) For Damping Rings Research and Development”, in Proc. of PAC 2009, Vancouver, (2009).
- [2] Y. Li, et al. “CesrTA Vacuum System Modifications”, in Proc. of PAC 2009, Vancouver, (2009), MO6RFP005.
- [3] E. Mahner, T. Kroyer, and F. Caspers, Phys. Rev. ST-AB 11, 094401 (2008).
- [4] J.P. Sikora, et al. “A Shielded Pick-up Detector for Electron Cloud Measurements in the CesrTA Ring”, BIW'10, Santa Fe, (May 2010), TUPSM072.
- [5] L. F. Wang, D. Raparia, J. Wei, and S. Y. Zhang, Phys. Rev. ST Accel. Beams 7, 034401 (2004).
- [6] J.A. Crittenden, et al. “Electron Cloud Modeling Results for Time-resolved Shielded Pickup Measurements at CesrTA”, WEP142, these proceedings.