

LONGITUDINAL DYNAMICS IN THE EMMA NS-FFAG

J. Garland, H. Owen, University of Manchester, UK
N. Bliss, J. Clarke, N. Marks, B. Muratori, STFC Daresbury Laboratory, UK.

Abstract

EMMA is the first non-scaling FFAG to be constructed, whose use of linear magnets means that the accelerating electron bunch rapidly crosses many resonances. We have modeled the capture and acceleration of bunches in the serpentine channel created by the radio-frequency cavities, and compare it to a proposed experiment in which induction cells allow slow acceleration. Two induction cores each providing ~ 20 kV over $1.65 \mu\text{s}$ enable a number of resonance crossing experiments.

INTRODUCTION

Non-scaling fixed-field alternating-gradient accelerators (ns-FFAGs) were proposed a few years ago [1, 2] as a way of achieving the large repetition rate possible in cyclotrons and scaling FFAGs whilst limiting the size of the magnets to a similar size to those in conventional synchrotrons; magnet size reduction is achieved by using strong focusing and removing the requirement for a constant tune. Such accelerators are therefore of great interest for rapid acceleration of unstable particles in future muon colliders, and for use in high-current, low-cost proton drivers, where the simpler magnets may also deliver increased flexibility and reliability. However, as the beam radius does not scale with energy, the dynamics can be significantly more complex, and a proof-of-principle electron machine - EMMA - has been constructed to examine in particular fast resonance crossing during acceleration [3].

The principal parameters of EMMA - which uses linear magnets - are given in Table 1, and the accelerator is shown in Fig. 1. It is important to note that since EMMA is a proof-of-principle machine, several of its features would not be carried over into a proton ns-FFAG: variable quadrupole and dipole fields for lattice studies are provided using 84 moving quadrupoles, and only single

bunch injection and extraction is carried out. Since $\beta \sim 1$, time-of-flight variation is essentially only from orbit shifts during acceleration. More complete information is given in a recent review paper [3].

Table 1: Principal EMMA Parameters

Lattice	42 cell FD
Circumference	16.57 m
Acceleration Range	10 to 20 MeV
RF Frequency	1.3 GHz
Number of RF Cavities	19
Max RF Voltage per Cavity/Turn	120 / 2280 kV
Bunch charge	40 -80 pC
Injection rate	5 Hz

LONGITUDINAL DYNAMICS

ns-FFAGs accelerate particles not by in-bucket acceleration, but along a so-called serpentine channel [3,4] that is opened up for a given RF frequency at a sufficient voltage per turn (see Fig. 2). The present 19 EMMA single-cell cavities operate at 1.3 GHz for compactness, and to be compatible with the ALICE accelerator where bunches are injected from. A simple 1D model (taking into account the time-of-flight variation with momentum) shows that only the vector sum voltage is important rather than the individual phases, and this is confirmed by a full ZGOUBI [5] model of the EMMA ring using realistic fields. Initial r.m.s. absolute phase errors of $\sim 20^\circ$ have been reduced to $\sim 10^\circ$ by minimising beam loading in each cavity, the total obtained voltage of >1 MV estimated by measurements of the synchrotron tune derived from turn-by-turn arrival time at an electron BPM pickup, and also indicated by comparing measured longitudinal phase space with tracking data for different injection phases.

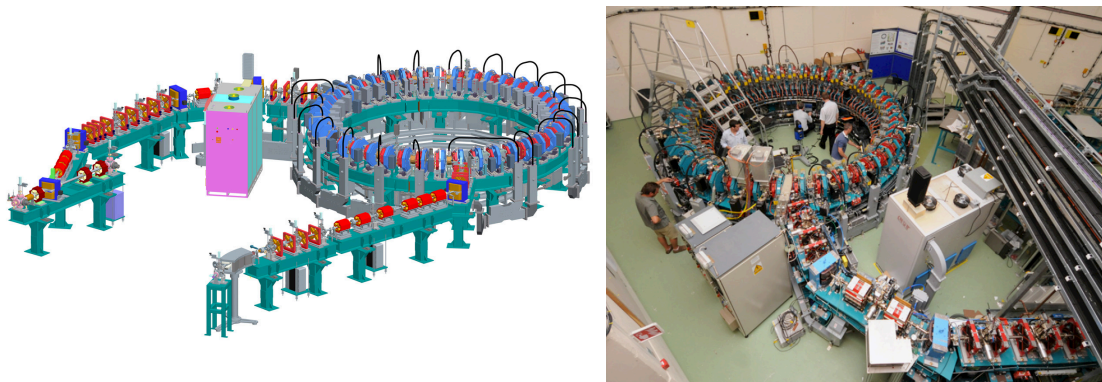

Figure 1: Layout of EMMA as installed at Daresbury Laboratory, showing injection line from ALICE (top left) and extraction line (bottom). Photograph shows installation progress in 2010 (before extraction line was installed).

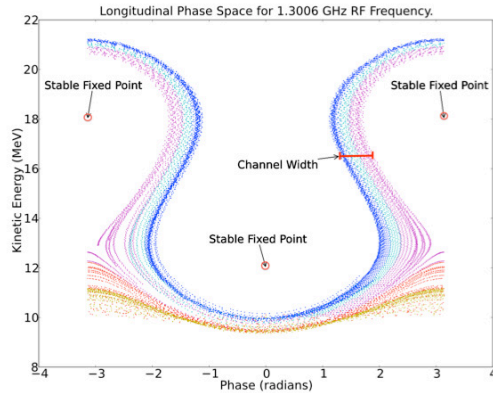

Figure 2: Injection at different phases for 1.37 MV total voltage per turn. The serpentine channel width at injection is very large at 100° , and reduces as acceleration takes place.

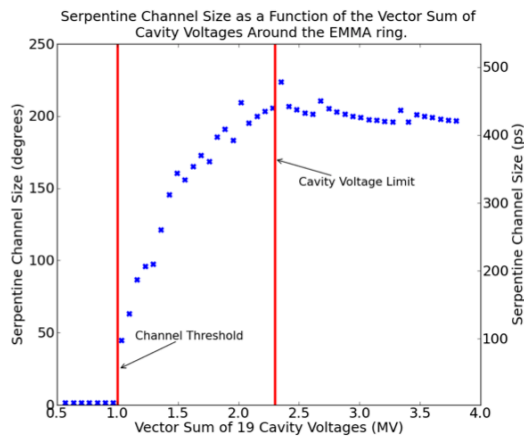

Figure 3: Simulated dependence of serpentine channel width on vector sum cavity voltage, showing ~ 1 MV threshold to open serpentine channel. The actual voltages used (up to 2 MV) are sufficient to readily allow the 10 ps long bunches from ALICE to be captured and accelerated.

ACCELERATION LIMITS

Successful acceleration requires:

- Sufficient voltage for capture into serpentine channel
- No transverse scraping/dynamic losses
- Extraction using septum + 2 kickers

Commissioning is presently in progress. Sufficient voltage has been shown to be present (see above). Extraction without acceleration has been confirmed, as shown in Fig. 4, and can be achieved after an arbitrary number of turns by adjustment of the extraction timing pulse. Transverse scraping therefore presently appears to be preventing straightforward acceleration (indicated by BPM signals but complicated by bunch decoherence) possibly due to residual closed-orbit errors from misalignments.

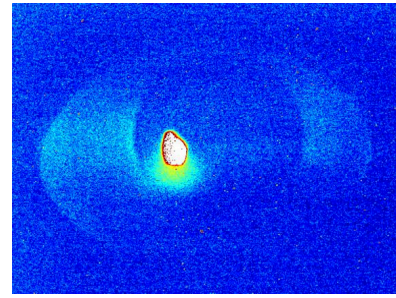

Figure 4: First beam extracted from EMMA, as observed at fluorescent screen between extraction septum and first dipole in extraction line.

INDUCTION CELL ACCELERATION

At present the EMMA RF system will allow the study of rapid tune-resonance crossing [6] using fast acceleration from 10 to 20 MeV in ~ 10 turns. To explore slow resonance crossing we require a lower voltage per turn; however, the serpentine channel disappears below 1 MV, so we need to use either a lower-frequency cavity or induction. We propose an experiment in which induction is used to provide around 1 MeV energy gain.

Induction acceleration may be produced either by using a single large core passing through the centre of the accelerator (a betatron-like method used in the first FFAG [8,9]), or by using multiple induction cells (ICs) as in an induction linac. The existing EMMA accelerator is incompatible with using a single core, which in any case could not produce a significant energy gain. We therefore propose to use two discrete cores – each with their own insulating gap – in a long-pulse scheme [10] (where the induction pulse lasts over many bunch turns), the total flux swing $2B_s$ through the core cross-section A determining the voltage-time product as

$$V \cdot \tau = 2AB_s \quad (1)$$

If we vary the number of turns and with it the pulse length, we note that the total energy gain is independent of the pulse length, being simply

$$\Delta E = 2AB_s \quad (2)$$

We have selected a pulse length such that the primary voltage is acceptable (see Table 2) using Metglas 2695CO as a core material [11]; a single turn primary must be used to limit the voltage. The mean core voltage of 17.5 kV is that seen by the beam during the 30 turns it is accelerated rather than the r.m.s. value (19.5 kV).

Table 2: EMMA IC Cell Parameters

Peak/Mean Core Voltage	27.6/17.5 kV
Peak Current	553 A
Effective Frequency	303 kHz
Total Acceleration Time	1.65 μ s
Core Cross Section	14600 mm ²
Max./Saturation B in Core	1.5 / 1.8 T

A preliminary engineering design of the core is shown in Fig. 5; Fig. 6 shows a core replacing one of the existing RF cavities presently installed in 19 of the (very short) straight sections. By replacing two RF cavities with induction cells we may vary the pulse length and thus the average voltage per turn by changing the relative phase of the primary pulses, as well as being able to vary the voltage of each cell, enabling a variety of slow acceleration experiments. To test that each induction cell is working *in situ* we can use its voltage to just open the serpentine channel (the remaining 17 RF cavities without ICs set at just below that threshold). This effect has been modelled and is shown in Fig. 7.

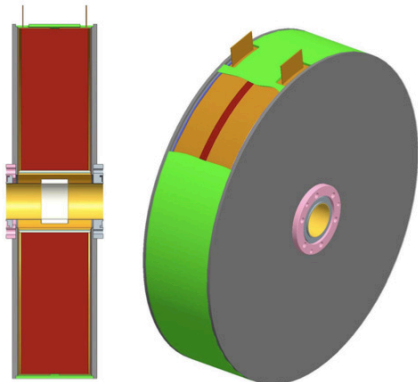

Figure 5: Engineering design for EMMA induction cell; the transformer primary winding shields the core; note the ceramic insulating gap in the beam vacuum vessel (left, in white).

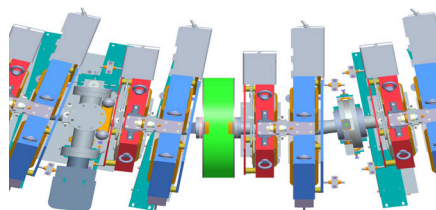

Figure 6: Position of induction cell in EMMA, replacing one existing RF cavity in the same location.

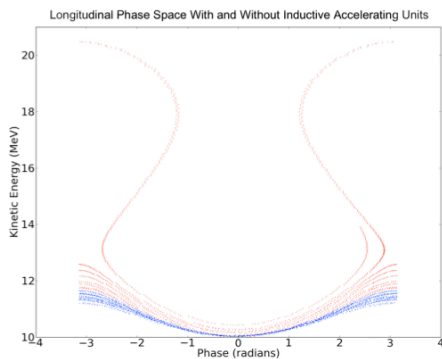

Figure 7: Use of hybrid RF/induction acceleration. Without ICs an injected bunch executes energy oscillations without entering a serpentine channel (shown in blue). Adding the IC voltage opens the channel and allows eventual acceleration (shown in red).

PROTON ACCELERATION USING INDUCTION CELLS

Betatron-like induction acceleration has already been used for a proton FFAG, but at low energy [9]. The total mass of core material scales linearly with energy gain (eqn. 2); an example is shown in Table 3; this large mass necessitates the use of cheaper core materials such as Silicon Steel which is limited to frequencies below 1 kHz. However, we believe their cost is still reasonable compared to RF acceleration, and in particular the supply circuit is simple and cheap to construct, and highly reliable to operate.

Table 3: Example Proton Induction Cell Parameters Using Silicon Steel

Acceleration Cycle	10 to 100 MeV
Circumference	51 m
Acceleration Time/turns	560 us / 1000
Number of Cores	24
Effective Frequency	820 Hz
Core Mass/Total Mass	21 / 510 tonnes
Core Cross Section	0.67 m ²
Max./Saturation B in Core	1.8 / 2.0 T

Induction cells have the advantage of being of similar cost or cheaper than RF, but with potentially much better reliability, making them advantageous to use in applications such as particle therapy or in accelerator-driven reactors. However, the smaller energy gain per turn and orbit separation of course makes low-loss extraction much more difficult; this question is presently under study.

REFERENCES

- [1] C. Johnstone, S. Koscielniak, *Nucl. Inst. Meth.* **A503(3)**, 445-457 (2003)
- [2] E. Keil, A.M. Sessler, Muon Acceleration in FFAG Rings, *Nuc. Inst. Meth.* **A538** (2005) 159-177
- [3] R. Barlow et al., *Nucl. Inst. Meth.* **A624**, 1-19 (2010)
- [4] J. Jones et al., *Progress in Physics* **1**, 72 (2010)
- [5] F. Meot, The Ray-Tracing Code Zgoubi, *Nucl. Inst. Meth.* **A427**, 353-356 (1999)
- [6] S. Machida, *Phys. Rev. STAB* **11**, 094003 (2008)
- [7] S. Machida, T. Uesugi, M. Aiba, *Nucl. Phys. B (Proc. Suppl.)* **149**, 320-322 (2005)
- [8] F.T.Cole, R.O. Haxby, *Rev. Sci. Inst.* **28(6)**, 403 (1957)
- [9] M. Tanigaki et al, 'Status of FFAG Accelerators in KURRI for ADS Study', Proceedings of EPAC 2006, <http://www.jacow.org/>
- [10] 'Induction Accelerators', ed. K. Takayama and R.J. Briggs, Springer (2011), ISBN 9783642139161
- [11] Metglas Inc. 440 Allied Drive, Conway, South Carolina 29526; <http://www.metglas.com/>