

ERL HOM ABSORBER DEVELOPMENT

M. Sawamura[#], JAEA, Tokai, Ibaraki, Japan
 T. Furuya, H. Sakai, K. Umemori, KEK, Tsukuba, Ibaraki, Japan
 K. Shinoe, ISSP, Univ. of Tokyo, Kashiwa, Chiba, Japan

Abstract

A superconducting main cavity for ERL has been designed and fabricated to reduce the HOM problem for the high current operation [1]. HOM power propagating along the beam pipe is damped at a HOM absorber installed between the cavities. The HOM absorber is cooled down to liquid nitrogen temperature in a cryomodule. The RF absorber material used for the HOM absorber is required to have good frequency and temperature properties. The frequency and temperature dependences of permittivity and permeability are measured for some ferrites with a cold test stand consisting of a GM refrigerator. The parameters of the HOM absorber such as length, thickness and position are optimized by calculation of microwave simulation codes. Test models of the HOM absorber are being designed and fabricated to test the RF, mechanical, cooling and temperature properties.

PROPERTIES OF RF ABSORBER MATERIAL

Frequency and temperature properties of permittivity and permeability for several RF absorber materials were measured. Nicolson-Ross method [2] was used to measure the permittivity and permeability. The procedure of this method is followings.

- 1) Manufacture material samples to a coaxial shape to set in the 7mm-connector type sample holder.
- 2) Measure s-parameters of reflection and transmission for the sample with a network analyzer.
- 3) Calculate the complex permittivity and permeability from the reflection and transmission coefficients.

The samples were cooled to measure the temperature property from 280 K to 40 K. A cold test stand with a GM refrigerator was used to cool the samples. This cold test stand consists of a GM refrigerator, a compressor, a vacuum chamber, a vacuum pump, and a temperature controller. The cold stage was set at the head of the GM refrigerator in the vacuum chamber. The temperature of the cold stage was controlled by the heater wound around the cold stage.

Calibration coefficients of the network analyzer depend on the temperature. Calibration must be done at each temperature of measurement. The procedure of the temperature property measurement is following.

- 1) Connect the calibration kit to the line from each port of the network analyzer and set the calibration kit on the cold stage.
- 2) Measure the s-parameters of the temperature

dependence by cooling with the cold test stand.

- 3) Change the calibration kit to the open, short, load and through terminations and repeat above.
- 4) Calculate the calibration coefficients at each temperature with the measured s-parameters [3].
- 5) Measure the s-parameters of the samples at each temperature.
- 6) Calibrate the sample s-parameters with the calculated calibration coefficients.
- 7) Calculate the complex permittivity and permeability with the calibrated sample s-parameters.

Eight ferrite samples are measured as shown in Table 1. Figure 1 and 2 show the frequency dependence of imaginary part of the ferrite permeability measured at 280K and 80 K. Though the frequency dependences of the ferrite samples are almost similar at 280 K, the ferrite samples show the quite different properties at 80 K.

The old-type IB004 supplied by TDK Corporation has been used for KEKB. The new-type IB004 is riddled of lead from the old-type IB004 to satisfy the RoHS criteria and adjusted to keep the property equivalent. Figure 3 shows the temperature dependence of permeability for new-type IB004. The permeability increases with the lower temperature except at the low frequency. This temperature dependence is suitable for the HOM absorber installed in the cryomodule.

Figure 4 shows the temperature dependence of Co2Z permeability. Permeability decreases for the low frequency and increases for the high frequency with the lower temperature.

Table 1: List of ferrite samples

Type	Supplier	Product
Ferrite	TDK Corporation	old-type IB004
		new-type IB004
	Trans-tech Inc	Co2Z
		Ferrite50
		TT2-111
		TT2-4000
	Nikko Co.	TT86-6000

OPTIMIZATION OF HOM ABSORBER SHAPE

The HOM absorber shape was optimized to achieve the HOM loss as much as possible. The ferrite Q-value was defined to evaluate the HOM loss at the ferrite in a similar way of the cavity Q-value.

[#]sawamura.masaru@jaea.go.jp

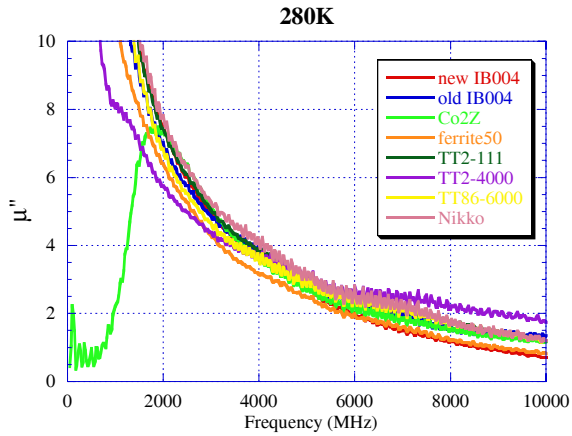

Figure 1: Frequency dependence of ferrite permeability at 280K.

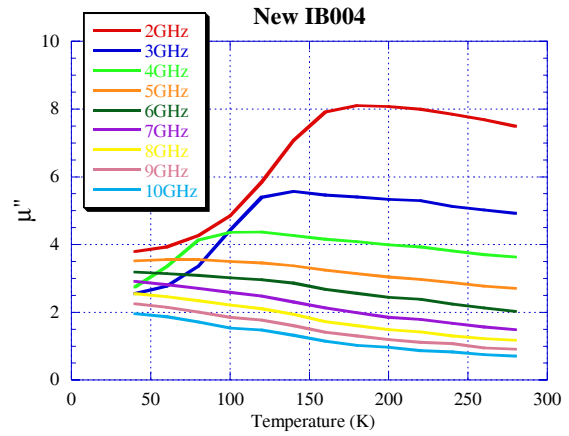

Figure 3: Temperature dependence of imaginary part of new-type IB004 permeability.

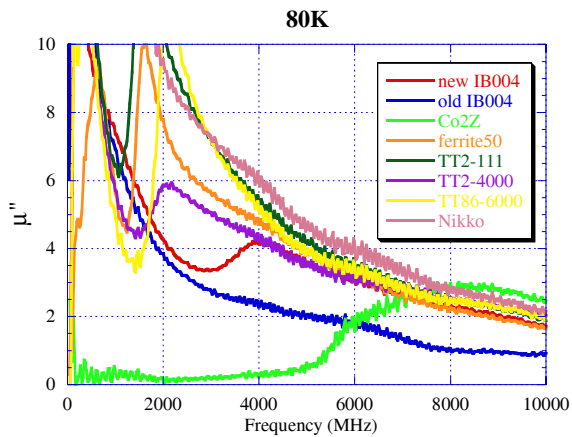

Figure 2: Frequency dependence of ferrite permeability at 80K.

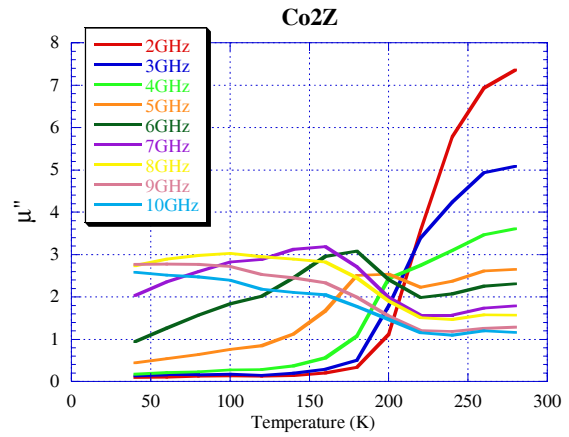

Figure 4: Temperature dependence of imaginary part of Co2Z permeability.

$$Q_{cavity} = \frac{\omega \times (\text{Stored Energy})}{\text{Cavity Wall Loss}}$$

$$Q_{ferrite} = \frac{\omega \times (\text{Stored Energy})}{\text{Ferrite Loss}}$$

CFISH was used to calculate the ferrite loss. The ferrite Q-values varied with the beam pipe length after the ferrite even though the ferrite shape is fixed as shown in Fig. 5.

The end of beam pipe determines the boundary condition of the standing wave. When the electro-magnetic wave transmits through the ferrite due to the insufficient absorption, the wave is reflected at the end of the beam pipe and passes through the ferrite again. The phases of the first and the second incident waves vary and the nodes of the standing wave shift with the beam pipe length. In our calculation the maximum Q-value is chosen as the ferrite Q-value while changing the beam pipe length with the fixed condition of the ferrite. Since this ferrite Q-value is the worst case of the beam pipe condition, the actual ferrite Q-value is expected to be lower than the calculated one.

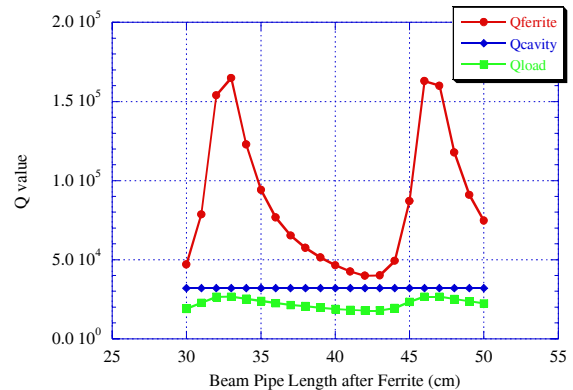

Figure 5: Ferrite, cavity and loaded Q-values as a function of the beam pipe length after ferrite.

TM011 mode was used to calculate the ferrite loss with CFISH. The beam pipe length was varied up to 20 cm apart from the ferrite end by 1 cm step. The ferrite permittivity and permeability is $\epsilon_r=10.34-0.0046 j$ and $\mu_r=0.188-5.5 j$ of old-type IB004 at 2.2 GHz.

Figure 6 shows the calculation of the ferrite Q-value as a function of the ferrite length with the ferrite thickness of 2

mm. The ferrite Q-value decreases as the ferrite length increases. The minimum Q-value and the ferrite position for this value are almost same. As the ferrite becomes longer, the difference between the maximum and the minimum gets smaller. The difference becomes less than 30 % over the ferrite length of 8 cm.

Figure 7 shows the calculation of the dependence of the ferrite thickness with the ferrite length of 10 cm. Though the thicker ferrite makes the minimum ferrite Q-value smaller, the difference between the maximum and the

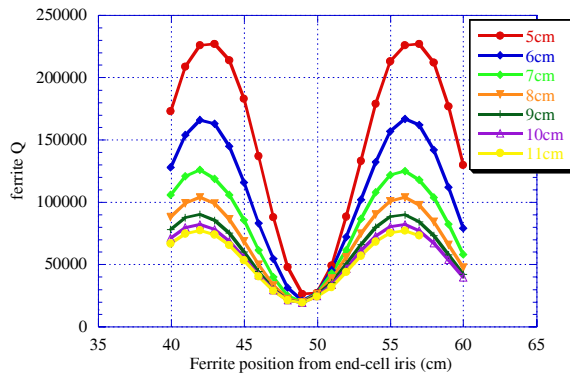

Figure 6: Calculation of ferrite length dependence of ferrite Q-value.

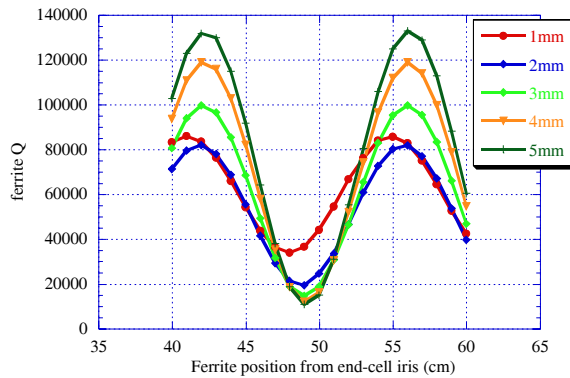

Figure 7: Calculation of ferrite thickness dependence of ferrite Q-value.

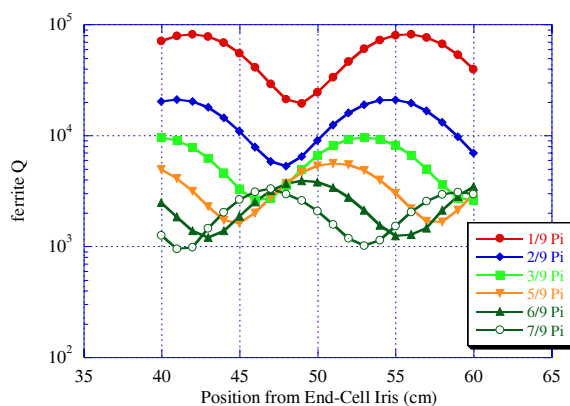

Figure 8: Calculation of TM011-mode dependence of ferrite Q-value.

minimum becomes larger. This means that the thicker ferrite realizes the large absorption in good condition and the small absorption in bad condition. The thicker ferrite increases the mismatch of the propagating HOM and reflection at the ferrite. This results in decrease of the ferrite loss.

Figure 8 shows the calculation of the dependence of the TM011-mode with the ferrite length of 10 cm and thickness of 2 mm. The Q-values vary periodically. The position of minimum Q-value and the period are different with the modes. The ferrite is required to be installed at the position where the Q-value becomes minimum for the highest Q-value mode.

MODEL OF HOM ABSORBER

The model of the HOM absorber is under design and fabrication with the results of the above measurement and calculation. HIP (Hot Isostatic Press) can bond the ferrite and the copper base firmly. This HIP process is adopted to prevent from the ferrite falling off from the HOM absorber. The bellows are used to increase allowance of the flange connection and the heat shrink. The comb-type RF bridge is adopted at the beam pipe connected with the bellows [4]. This comb-type RF bridge has advantages of low impedance and small heat conductance compared with the finger-type RF connector. The layout of the HOM absorber is shown in Fig.9.

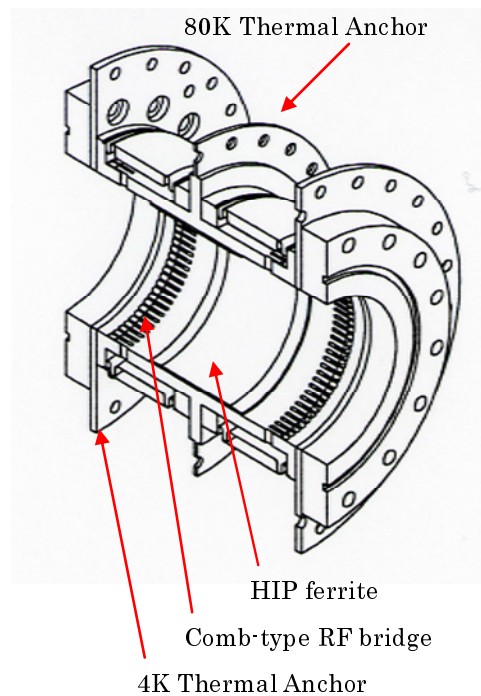

Figure 9: Layout of HOM absorber model

CONCLUSION

The frequency and temperature dependence of the RF absorber were measured. The new-type IB004 is chosen for our HOM absorber material due to good property at low temperature.

The calculation of the ferrite loss shows that 8 cm length and 2 mm thickness is enough to achieve large ferrite loss.

The frequency and temperature property of HIPped ferrite is going to measure. The HOM absorber models without and with ferrite are under fabrication. The HOM absorber without ferrite will be used for the test of cooling capability. The HOM absorber with ferrite will be used for the test of HOM damping property and ferrite mechanical tolerance for low temperature and heat cycle from room temperature to 80 K.

REFERENCES

- [1] K.Umemori et al., Proc. APAC2007, 570-572, 2007
- [2] A. M. Nicolson and G. F. Ross, IEEE Transactions and Instrumentation and Measurement, Vol. IM-19, pp.377-382, Nov., 1970
- [3] Agilent AN 1287-3, "Applying Error Correction to Network Analyzer Measurements"
<http://cp.literature.agilent.com/litweb/pdf/5965-709E.pdf>
- [4] Y.Suetsugu, et al., Proceedings of the 5th Annual Meeting of Particle Accelerator Society of Japan and the 33rd Linear Accelerator Meeting in Japan, August 6-8, 2008, pp. 200-202 (in Japanese)