

STATUS OF 9-CELL SUPERCONDUCTING CAVITY DEVELOPMENT FOR ERL PROJECT IN JAPAN

K. Umemori[#], T. Furuya, H. Sakai, T. Takahashi, KEK, Tsukuba, Ibaraki, Japan
 K. Shinoe, ISSP, University of Tokyo, Kashiwa, Chiba, Japan
 M. Sawamura, JAEA-ERL, Tokai, Naka, Ibaraki, Japan

Abstract

Superconducting cavities have been developed for realizing the high current future ERLs. Along with high accelerating gradient of 15~20 MV/m, strong HOM damping is important issue for the ERL main linac. We designed an HOM damped 9-cell cavity and fabricated a niobium 9-cell proto-type cavity. After a series of surface treatments, vertical tests were performed. At present, the accelerating gradient is limited to 15-17 MV/m due to field emissions. A rotating X-ray mapping system was developed and observed some X-ray traces. We report on these activities.

INTRODUCTION

At the ERL, stable operations are required for the superconducting cavities, with CW high current beam. This leads to stringent requirement against HOMs. Required features are following:

- Frequency 1.3 GHz
- Accelerating gradient 15~20 MV/m
- CW high current beam operation (> 100 mA)
- Energy recovery should work

Higher accelerating gradient may be generally desirable. In the case of ERL, however, higher gradient leads to more enormous cryogenic heat loss, since the loss increases with square of the gradient. It is considered that around 15 MV/m is adequate for the main linac.

There are two requirements against HOMs. One is suppression for the dipole and quadrupole HOMs. They can induce BBU and quadrupole BBU instabilities, which cause the current limit and/or emittance growth. Another is requirement for monopole HOMs. They lead to heat loss at the HOM absorbers. In order to achieve strong HOM damping, we decided to use beampipe HOM damper with RF absorber, as shown in Figure 1. These HOM absorbers are located inside cryomodule, at temperature of 80 K. Frequencies of monopole HOMs should be selected not to be close to the integral multiples of beam frequency.

KEK-ERL MODEL-2 CAVITY

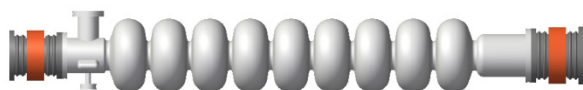

Figure 1 : Schematic view of the KEK-ERL model-2 cavity.

As mentioned above, sufficient HOM suppression is required for the ERL main linac. To meet such conditions, we optimized cavity cell shapes and designed KEK-ERL

model-2 cavity [1], whose schematic view is shown in Figure 1. Points of design are following.

- (1) Cell shapes were optimized to HOM suppression. Diameter of iris was chosen to be 80 mm. The HOMs can easily propagate between cells.
- (2) Diameters of beampipes were selected to be 100 and 120 mm. All monopole and dipole HOMs can propagate to beampipes and are damped by RF absorber.
- (3) EFB (Eccentric fluted beampipe) was applied, in order to damp quadrupole HOMs. The EFB acts as mode converter from quadrupole to dipole mode, due to its asymmetric structure [2].

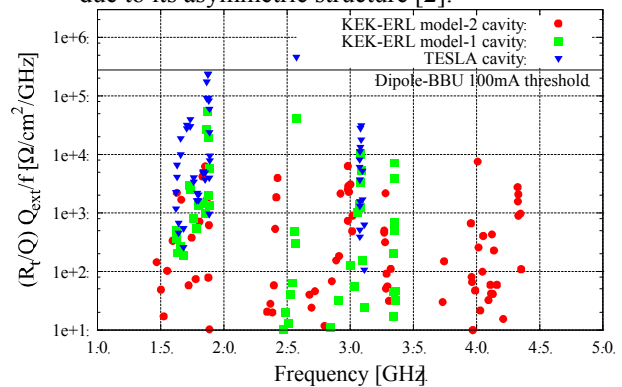

Figure 2 : Spectrum of the dipole HOMs. Details seen in ref [1].

As a result, impedances of HOMs can be enough damped, while keeping 9-cell structure. Figure 2 shows spectrum of dipole HOMs. Vertical axis is $(R_t/Q)Q_{ext}/f$ [$\Omega/\text{cm}^2/\text{GHz}$], which is a measure of BBU instability threshold. There is enough margin for 100 mA operation. Current threshold against BBU instability is estimated to be several 100 mA from computer calculations [3].

Main parameters are listed in Table 1. Cell-to-cell coupling becomes large due to large iris diameter. This is a merit to keep field profile. It is less sensitive to variation of cell frequencies. The value R_{sh}/Q becomes around 900 Ω . A demerit is increase of E_{peak}/E_{acc} , which is 3.0. Enough suppression of field emissions is experimental issue.

Table 1 : Parameters for KEK-ERL model-2 cavity

Frequency	1.3GHz	Coupling	3.8 %
R_{sh}/Q	897 Ω	Geom.Fac.	289 Ω
E_{peak}/E_{acc}	3.0	H_{peak}/E_{acc}	42.5Oe/(MV/m)

In order to verify this cavity design, two types of single-cell cavities were fabricated. One is the “C-single” cavity, whose cell shape is same as that of center-cells. Another is the “E-single” cavity, which is a combination

[#]kensei.umemori@kek.jp



Figure 3 : Proto-type of KEK-ERL model-2 cavity for main linac.

of the both end-cells with complicated beampipe structures [4]. After confirming their characteristics, a proto-type of 9-cell KEK-ERL model-2 cavity was manufactured. It is shown in Figure 3. No stiffening rings were mounted at iris part. Both flanges at the cavity ends were niobium. Vacuum seal was done using indium seal. Electron-beam-welded equator and iris parts were buffed with #400, in order to remove welding defects.

After receiving, the cavity was electro-polished (130 μ m) and annealed at 750 degree. Field flatness of 98 % was achieved by the pre-tuning procedure. Then, it was followed by final-EP (20 μ m), hot bath rinsing, HPR, assembly and baking.

EXPERIMENTAL SETUP



Figure 4 : Installing 9-cell cavity to cryostat

Vertical tests have been performed at KEK-STF vertical test area. Figure 4 shows the installation of the 9-cell cavity to the cryostat. An input coupler was mounted on the upper flange of the cavity. Its coupling is variable. It can obtain matching condition while cooling down from 4K to 2K and also for all TM010 pass-band measurements.

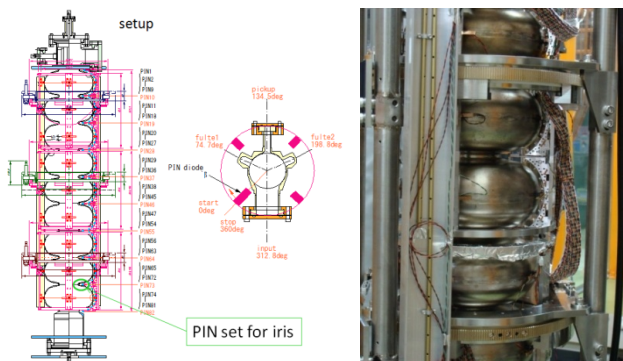

Figure 5 : (Left) Layout of Si PIN diodes for the rotating mapping system. (Right) Mapping system mounted on the cavity.

For the cavity diagnostics, many carbon resistors and Si PIN diodes are used to monitor temperature and X-rays. Left picture of Figure 5 show the layout of the rotating mapping system and right picture shows a part of it. Array of Si PIN diodes rotates 360 degree around the cavity surface and observes X-ray traces. Total of 82 Si PIN diodes are mounted for monitoring nine cells. One data can be taken with a few minutes.

Table 2 : History of vertical tests and surface treatments

	Surface treatment	Maximum gradient	Comment
Before vertical tests	EP(130 μ m), Annealing, EP2(20 μ m), HPR, Baking	---	---
1 st test	---	15 MV/m	Field emission Many heat spot
2 nd test	Baking	15 MV/m	Field emission Many heat spot
3 rd test	HPR, Baking	15 MV/m	Field emission Many heat spot
4 th test	EP2(50 μ m), HPR, Baking	17 MV/m	Field emission A few heat spot
5 th test	Nothing	16 MV/m	Field emission A few heat spot (same with 4 th)

Table 2 shows the history of vertical tests and surface treatments. Total of five vertical tests have been performed. The first test was aimed to check the vertical test system. After the first test, only baking was done and the second test was performed. Additional HPR was applied after the second test. After the third measurement, field flatness was checked and it was kept about 95 %. Thus, we did not apply re-tuning. Before the fourth test, additional EP was applied and removed 50 μ m of surface. Hot bath rinsing, HPR, assembly and baking were done. After the fourth test, nothing was done, since aim of the fifth test was to obtain detailed X-ray mapping data.

Fixed mapping system was used from the first to third vertical tests, and the rotating mapping system was used for the fourth and fifth tests.

RESULTS OF VERTICAL TESTS

The results of vertical tests are shown in Figure 6. The Q_0 -Eacc curves are plotted for 2K and 4K measurements. Generally speaking, at all vertical tests, field emission

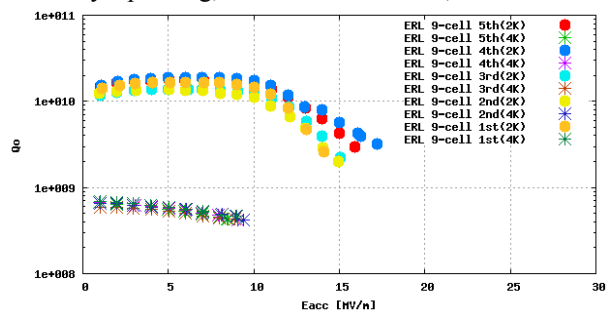

Figure 6 : Results of vertical tests for KEK-ERL model-2 cavity.

started around $E_{acc} = 10$ MV/m and fields were limited at 15~17 MV/m. The reason of field limitation was heating due to field emissions.

Figure 7 shows the R_s-1/T curve, taken during cooling down from 4K to 2K. Residual resistances were estimated as to be 15~20 nΩ from the fitting results.

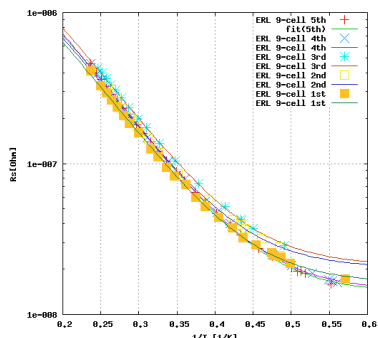

Figure 7 : R_s-1/T curve for KEK-ERL model-2 cavity.

The Q_0-E_{acc} curves, shown in Figure 6, seem almost same for all measurements. However, it is noted that details of emission and temperature rise are much different each other, if looking at additional data, such as, X-ray signals, place of temperature rise and results for pass-band measurements. Only the fifth test was well reproduced the details of the fourth vertical test.

RESULTS OF X-RAY MAPPING

Figure 8 shows an example of X-ray mapping. This data was taken at $E_{acc} = 13.9$ MV/m at fourth test. In the figure, “1 cell” is the cell which is close to the input port and “9 cell” is opposite side. The X-ray signal is strong at around iris parts. There are two characteristic signals. One is a very strong and sharp peak, observed at 330 degree at iris between 8-cell and 9-cell. Looking at the details, clear X-ray trace can be seen. Another is a broad signals, observed at around 150 degree, opposite side of sharp peak, at irises from 1-cell to 6-cell. These signals appeared at the same time around $E_{acc} = 10$ MV/m. Larger the accelerating gradient, these signals became stronger.

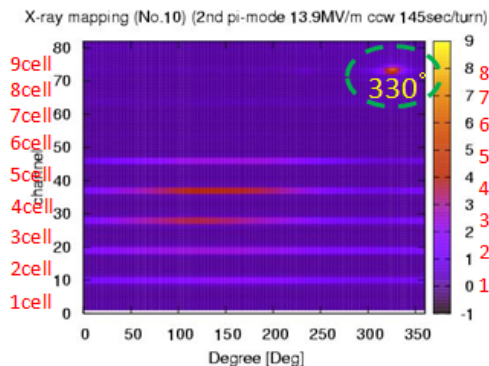

Figure 8 : Observed X-ray mapping at $E_{acc} = 13.9$ MV/m at the fourth vertical test.

The X-ray mapping data was observed also for TM010 pass-band modes. Same sharp signal, at 330 degree of iris between 8-cell and 9-cell, could be seen for $8\pi/9$, $7\pi/9$, $6\pi/9$ modes. The broad signals at irises around 1 to 6-cells

were not seen this time. Probably, this was caused from the difference of the field patterns. For some other modes, X-ray signals appeared at different positions. Observed X-ray pattern changed depending on the measured modes.

After the fifth measurement, inner surface of the cavity was observed using an inspection camera, so called Kyoto camera system [5]. A big tip was found, as shown in Figure 9, at 150 degree at the iris between 8-cell and 9-cell. Its size is several hundred μm diameter and several ten μm height. The surface inspection was also done after the third vertical test, but no such tip was observed. No such tips or dips were found at any other areas.

It is very interesting that the tip was observed at just opposite side of the sharp X-ray peak observed on mapping. Most probably, this tip was the source of the field emission for the fourth and fifth vertical tests.

This tip will be removed by grinding. Then cavity will be electro-polished again and performed vertical testing.

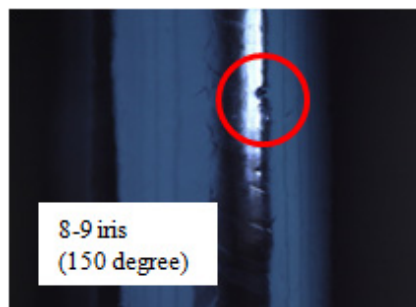

Figure 9 : Inspection of cavity inner surface. A tip was found at iris between 8-cell and 9-cell.

CRYMODULE DEVELOPMENT

Peripheral equipments, such as the input coupler [6] and the HOM absorber [7], have been also developed. The input coupler is designed to pass through maximum of 20 kW power, at accelerating gradient of 20 MV/m, considering the detuning due to microphonics. It has cold and warm windows. For ceramic window, HA997 is selected to lower the dynamic loss. Coupling is variable, between the ranges of Q_{ext} from 5×10^6 to 2×10^7 . To verify the components, such as ceramic windows and bellows, a test stand was constructed at JAEA and high power tests have been performed. The proto-type of windows and high power test stand are shown in Figure 10.

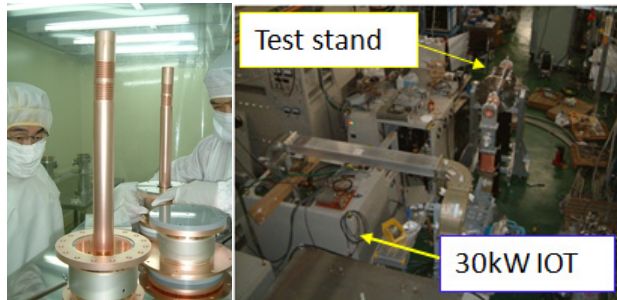

Figure 10 : (Left) proto-type of warm and cold windows. (Right) High power test stand constructed at JAEA.

The HOM absorber will be installed inside the cryomodule and used at 80 K. RF absorbers, used for

HOM damping, should have enough absorption capability, at 80 K, for broadband frequency range. Temperature dependence of complex permeability and permittivity were measured for around 10 RF absorber samples.

Left plot of figure 11 shows temperature dependences of μ'' of ferrite IB004, for the frequency range from 2 to 6 GHz. It seems that IB004 can be used at 80K, at least up to around 10 GHz.

The development of the HOM absorber is in progress. The thickness, length and location of the ferrite were carefully optimized. Right of Figure 11 shows the schematic view of the HOM absorber. Ferrite IB004 is HIP bonded to Cu beampipes. Inner side of bellows is covered with Comb-type RF bridge. The proto-type of it is now under construction.

Design of the cryomodule is now under discussion. First module will include two 9-cell cavities, for the Compact ERL project at KEK [8].

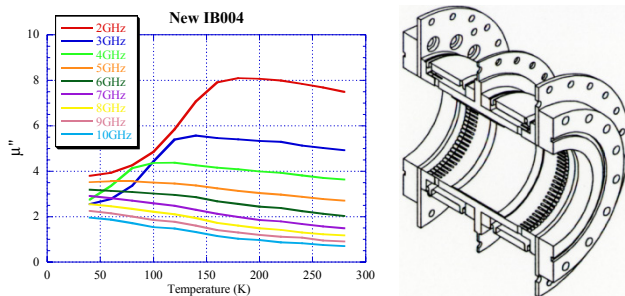

Figure 11 : (Left) Temperature dependence of ferrite IB004. (Right) Schematic view of the HOM absorber.

SUMMARY

The HOM damped 1.3 GHz superconducting cavity was designed for the ERL main linac. Niobium 9-cell proto-type cavity was fabricated and vertical tests were performed after a series of surface treatments. At present, accelerating gradient is limited by field emissions. The

rotating X-ray mapping system was constructed and worked well. Clear X-ray traces were observed. After vertical tests, the cavity surface was inspected and a tip was found. It is probably the source of field emission. We will try to improve cavity performance by removing this tip and re-cleaning the cavity surface. Design of the cryomodule is ongoing for the Compact ERL project. The input coupler and HOM absorber are also being developed.

REFERENCES

- [1] K. Umemori *et al.*, "Design of L-band superconducting cavity for the energy recovery linacs", APAC'07, Indore, India, Feb 2007, p.570(2007)
- [2] M. Sawamura *et al.*, "Quadrupole HOM damping with eccentric-fluted beampipes", PAC'07, Albuquerque, New Mexico, Jun 2007, p.1022 (2007)
- [3] R. Hajima *et al.*, "Analysis of HOM-BBU with newly designed cavities for a multi-GeV ERL light source", ERL'07, Dresbury, May 2007 (2007)
- [4] K. Umemori *et al.*, "Results of vertical test for the KEK-ERL single cell superconducting cavities", EPAC'08, Genoa, Jun 2008, P.925 (2008)
- [5] Y. Iwashita *et al.*, "Development of high resolution camera for observations of superconducting cavities", Phys. Rev. ST Accel. Beams 11, 093501 (2008)
- [6] H. Sakai *et al.*, "Development of input power coupler for ERL main linac in Japan", in these proceedings, THPPO047
- [7] M. Sawamura *et al.*, "ERL HOM absorber development", in these proceedings, THPPO050
- [8] R. Hajima *et al.* (ed.), KEK Report 2007-7/ JAEA-Research 2008-032 (2008) [in Japanese]