

## MHI'S PRODUCTION ACTIVITIES OF SUPERCONDUCTING CAVITY

Akihiro Miyamoto, Hiroshi Hara, Kohei Kanaoka, Kazunori Okihira, Katsuya Sennyu, Takeshi Yanagisawa, Mitsubishi Heavy Industries, Ltd, Mihara, Japan

### Abstract

Mitsubishi Heavy Industries, LTD. (MHI) has been developing manufacturing process of superconducting cavities. 4 topics of our recent activities, QWR, facilities of surface preparation, Superconducting RF electron gun and EBW of 4 cavities in a batch, are introduced in this report.

### QWR AND CRYOMODULE

MHI has supplied superconducting RF cavities and cryostats for electron accelerators for various project such as STF and ERL project by KEK[1].

And now MHI is developing superconducting QWR cavity of heavy ion accelerator for the RIBF Upgrade plan [2] in collaboration with RIKEN and KEK.

RF frequency of prototype cavity is 75.5MHz. Cavity height is 1055mm, and diameter is 300mm. An exploded view of Superconducting QWR cavity is shown in Figure1.

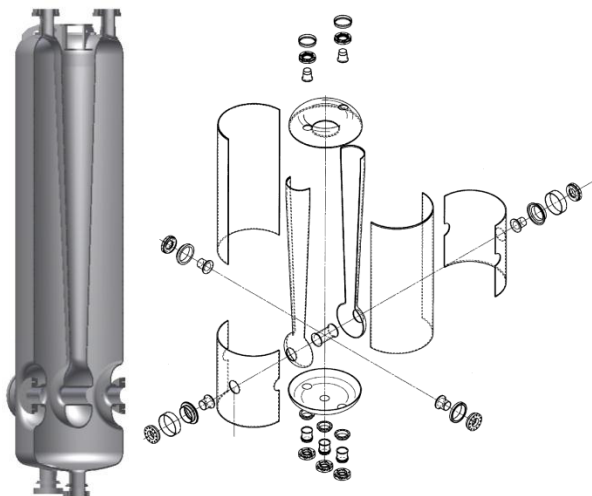

Figure 1: An exploded view of Superconducting QWR cavity.

Pure niobium is processed by machining or pressing. And each component is assembled by EB welding. In order to reduce the number of welding point, we have tested to press drift tube and stem in a one piece.

In order to avoid crack and wrinkle, adequate forming load and shape of a press mould are analysed using LS-DYNA code (See Figure 2 and Figure 3) .

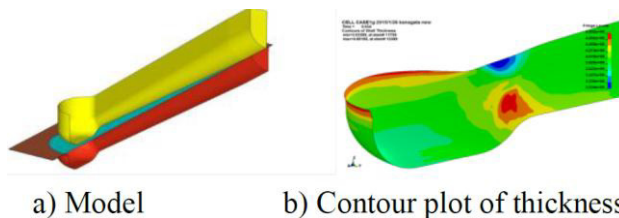

Figure 2: Forming analysis model and result.

As the result of press test, drift tube and stem are pressed successfully as a one piece. The precision of shape is below 0.5mm, and variation of thickness is below 15%.



Figure 3: Test piece of forming.

A plan of prototype cryostat is shown in Figure 4. In this cryostat, 2 superconducting RF cavities are installed. The operating temperature is 4.2K. Cryostat equips thermal shield for Helium 40K, and Helium 40K is cooled by small refrigerator.

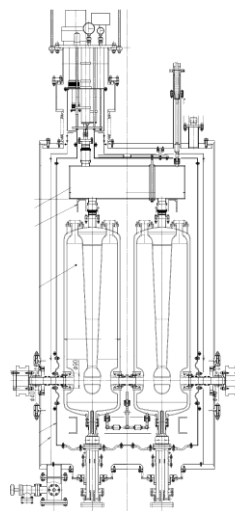

Figure 4: prototype of cryostat.

### FACILITIES OF SURFACE PREPARATION

MHI is planning to install facilities for surface preparation in order to integrate total process of production of superconducting RF cavity. Facilities of Buffered Chemical Polish (BCP), Ultrasonic bath and High pressure rinse are planned to be installed in factory within this year.

#### BCP

Schematic diagram of BCP facility is shown in Figure 5. Apparatus consists of acid tank with heat exchanger, water tank, water chiller, scrubber, acid pump, water pump and piping. Table 1 is specification of BCP facility. This facility enables BPC process of superconducting RF cavity.

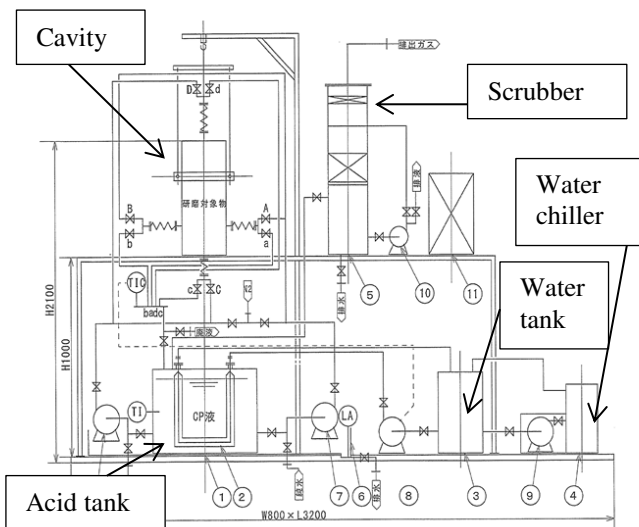

Figure 5: Schematic diagram of BCP facility.

Table 1: Specification of BCP Facility

Item	Value
Acid	Mixture of HF, HNO3 and H3PO4
Temperature control of acid	14-20deg.C
Acid flow	1-30L/min
Volume of cavity	100L
Rinsing	Pure water

#### Ultrasonic Bath

Superconducting RF cavity is cleaned after BCP process using this ultrasonic bath. Outline of ultrasonic bath is shown in Figure 6. And specification is in Table 2.

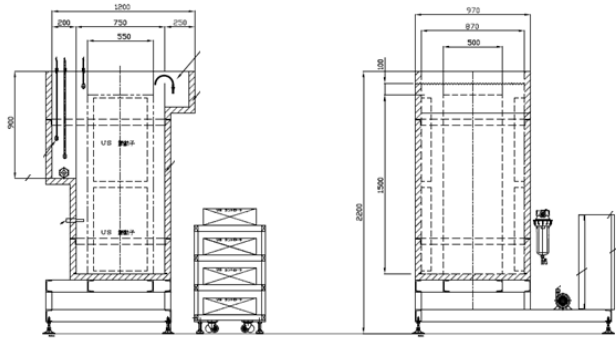

Figure 6: Outline of ultrasonic bath.

Table 2: Specification of Ultrasonic Bath

Item	Value
Material of tank	Stainless steel
Maximum size of object	L500 x W550 x H1500mm
Cleaning medium	Pure water + detergent
Ultrasonic	40kHz, max 8000W
Temperature	Max 50 deg.C
Circulation	Max. 40L/min
Rinsing	Pure water

#### High Pressure Rinse, HPR

Superconducting RF cavity is high pressure rinsed with ultra-pure water. Outline and specification are shown in Figure 7 and Table 3. This facility has 4 axes movements. This makes it possible to perform high pressure rinse of complicated shaped cavity such as QWR.

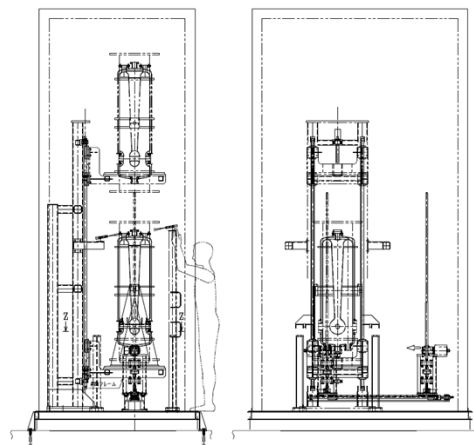

Figure 7: Outline of High pressure rinse facility.

Copyright © 2015 CC-BY-3.0 and by the respective authors

Table 3: Specification of High Pressure Rinse Facility

Item	Value
Specific resistance of Ultra-pure water	> 18M $\Omega$ cm
Water Pressure	Max 10MPa
Water Flow	Max 10L/min
Movement	4 axes Vertical movement of cavity, Cavity rotation around vertical axis, Rotation of cane, Horizontal movement of cane

### Clean Area

Final assembly of superconducting RF cavity is performed in clean area. We have introduced KOACH by KOKEN Ltd. This advanced apparatus for clean room technology enables to keep clean area even if area is not covered by closed clean room. Coherent flow of filtered air, generated from apparatus, makes area clean enough to assemble superconducting RF cavity. [3] Table 4 is specification of clean area. And Figure 8 is the picture of KOACH.

Table 4: Specification of Clean Area

Item	Value
Class of clean room	Class 100 (ISO-4)
Type	Horizontal coherent flow from side wall
Location	Inside of class 10000 clean room

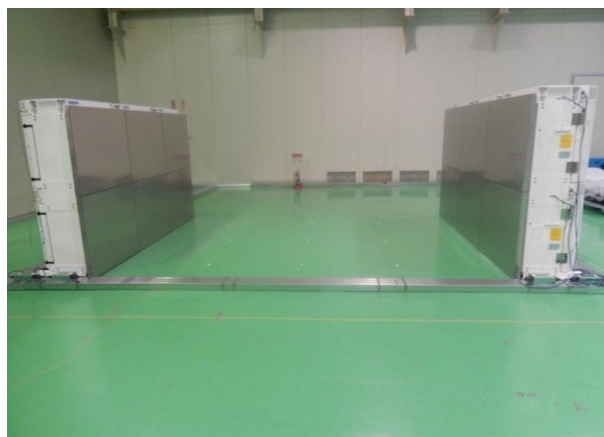

Figure 8: KOACH by KOKEN Ltd.

## SUPERCONDUCTING RF ELECTRON GUN

The electron gun with high intensity and narrow energy spectrum is required for the accelerator of next generation ERL and FEL systems. In order to achieve this, MHI has developed SRF electron gun in collaboration with KEK.

Specification of SRF electron gun is shown in Table 5.

Table 5: Specification of SRF Electron Gun

Item	Value
RF frequency	1.3GHz
The number of cells	1.5cells
Beam energy	2MeV
Average beam current	100mA
Initial beam diameter	2mm
Emittance	< 1mm mrad
Bunch length	10ps
Beam energy spread	< 2keV (<0.1%)

Electric field distribution calculated by SUPERFISH is shown in Figure 9. And Figure 10 is the picture of first Prototype. Vertical test has been performed by KEK and cavity has reached to the target electrical field strength without field emission. [4]

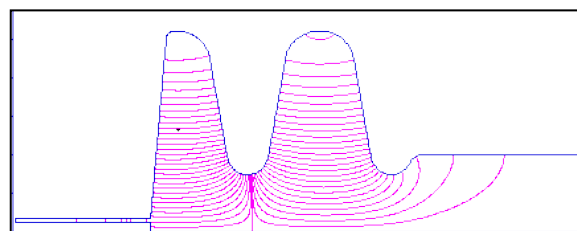

Figure 9: Electric field distribution of superconducting RF electron gun.



Figure 10: First prototype.

And we are also studying for next prototype. One of the purposes of this second prototype is development of coupler. We are now designing coupler for second prototype. Two coaxial RF couplers are connected to SRF

electron gun. Nominal output power of each coupler is 100kW. And two couplers fed RF power 200kW to cavity.

Another purpose of second prototype is choke structure of cavity. It is desired that photo cathode can be replaced in case that cathode is damaged. In order to achieve this, cathode holder can be removed from cavity. A connection to the cavity by choke structure enables this without loss of RF power (Figure 11).

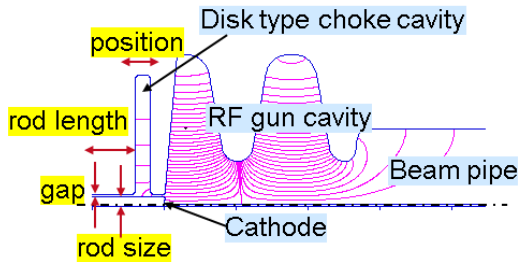

Figure 11: Choke structure of cathode holder.

### EB WELDING OF 4 CAVITIES IN A BATCH

MHI has the EBW machine in which four 9-cell cavities can be set vertically. All equators of four 9-cell cavities can be welded in one batch using this. Figure 12 is the picture of cavity welded in this manner. The process is described in Table 6.

Table 6: The Process of EB Welding

Step	Action
1	The cavity parts are piled up on a welding jig.
2	Chamber of EBW is evacuated by pump.
3	One of four stacks of the cavities is moved to the position of welding.
4	The electron beam is irradiated horizontally, cavities are rotated along axis of cavity and seam of equator is welded.
5	Electron gun is moved vertically to the position of next equator
6	Step 4 and 5 is repeated until all equators of 9-cell cavities are welded.
7	Next stack of 9-cell cavities is moved to the position of welding.
8	Step 4, 5, 6 and 7 are repeated until all 9-cell cavities are welded.
9	Chamber of EBW is opened and cavities are taken out.

In this way, we can weld a lot of cavities efficiently. We succeeded in welding all seams of equator of four cavities in one batch. One of these cavities reached 34.9 MV/m

by the vertical test in KEK (See Figure 13 for the result of vertical test).

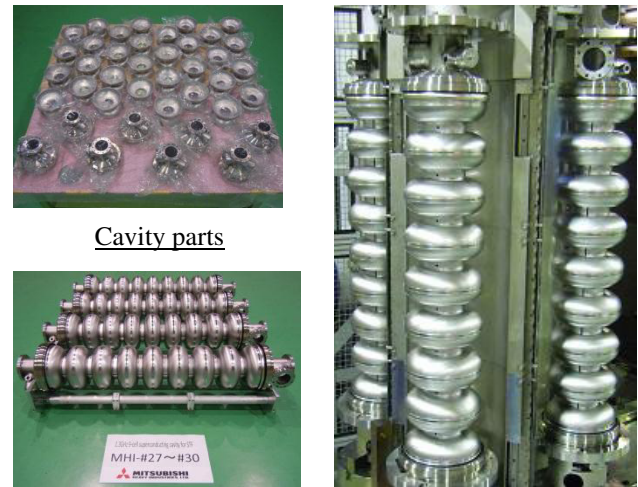

After welding

Assembling process

Figure 12: Welding of four cavities in one batch.

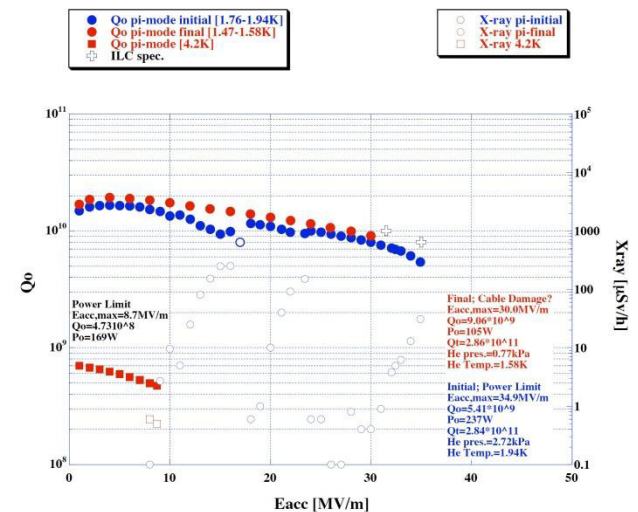

Figure 13: Result of vertical test of cavity that was welded by one batch.

### CONCLUSION

Our recent activities about development of SRF accelerator are reported in this paper.

- We are developing SRF QWR cavity of heavy ion accelerator in collaboration with RIKEN and KEK.
- Equipment for surface preparation is planned to be installed in factory.
- We are developing SRF electron gun in collaboration with KEK.
- We succeeded in welding all seams of equator of four cavities in one batch.

## ACKNOWLEDGMENT

We acknowledge the support of SRF group in KEK and RIKEN for our usual activities of development of SRF accelerator.

## REFERENCES

- [1] T. Yanagisawa et al., "Status of the Superconducting Cavity Development for ILC", MOP055, SRF2013, Paris, France, (2013).
- [2] K. Yamada et al., "Design of a new superconducting Linac for the RIBF", THPP118, LINAC2014, Geneva Switzerland (2014).
- [3] S. Maeda, "Introduction of open clean bench of class 1 for (beam line) assembly work", ID49, TTC Meeting at KEK, December 2 - 5, (2014).
- [4] T. Konomi, "Vertical Test of the Superconducting RF GUN Cavity at KEK", WEOM03, The 12th Annual Meeting of Particle Accelerator Society of Japan (2014).