

FIELD EMISSION IN RF CAVITIES : OBSERVATION OF LIGHT SPOTS AT HIGH ELECTRIC FIELDS

T. Junquera, A. Le Goff

Institut de Physique Nucleaire (CNRS-IN2P3) 91406 Orsay France

B. Bonin, H. Safa, J. Tan

DSM/DAPNIA/SEA CE-Saclay 91191 Gif sur Yvette France

ABSTRACT

Light emission associated with electron emission in metallic surfaces exposed to high electric fields has been reported by several authors in both D.C. and R.F. experiments. These observations have been employed to support different models of the field emission phenomena. In this paper we present an optical system for the observation and study of light emission in RF cavities. The first results obtained with a special copper cavity equipped with removable samples are presented. Light spots were clearly observed and some physical parameters (geometrical, field dependence, intensity, radiation spectrum and time evolution) have been measured in preliminary experiments. This optical system provides an interesting tool for field emission studies in RF cavities: high spatial resolution for light spots detection and straightforward measurement of optical radiation.

INTRODUCTION

Several authors have reported observations of light emission associated to electric field emission in different experimental conditions. Hurley and Dooley [1] [2] have observed light spots in D.C. field emission experiments on different samples placed in high electric fields $E > 5$ MV/m. The spots were localised and its characteristics measured (light intensity vs., electric field, light spectrum), showing a close behaviour to the electroluminescence phenomena. The authors concluded by proposing a model where the electron emission sites found on metallic surfaces are associated with semiconducting type impurities located at the grain boundaries or other defects in the metal surfaces.

Light emission observations in RF cavities have also been reported and some interesting experimental results were presented. At CERN, with a monocell superconducting cavity

(500 MHz), light emission was detected by a photomultiplier through a view port installed at the upper beam tube [3]. Measuring the light intensity as a function of the electrical field, an experimental law was founded which is well supported by a model considering the black body radiation from a small particle, insulated from the Nb wall, which is heated by the RF field.

The study of light emission in RF cavities could strongly contribute to a further understanding of the electron emission phenomena. Some optical measurements could bring interesting data to elaborate a more complete model able to explain the origin and mechanism of the field electron emission.

In this paper we present the first results obtained with an optical system adapted to a 1.5 GHz copper cavity. The main aim was to experimentally prove the working principle and to evaluate the localisation and measurement capabilities of such a diagnostic tool.

1 - THE 1.5 GHz COPPER CAVITY

The GECS group in France has started a study on electron emission in D.C. and RF cavities. The understanding of field emission in metallic surfaces placed in strong RF fields could contribute to improve the gradient obtained in superconducting cavities for electron accelerators [4] [5] [6].

Concerning the RF experiments, the Saclay group has built a copper cavity at room temperature equipped with a removable sample. The experimental work at room temperature can be totally applied to metal surfaces working at cryogenics temperatures and the simple copper cavity offers a fast turnover of the experiments [6].

A 1.5 GHz re-entrant cavity was designed (Table I) with diameter 100 mm and height 42 mm, presenting a high electrical field over the removable sample surface.

Frequency	1495 ± 5 MHz
Maximum RF power	5 kW
Maximum average power	< 50 W
Maximum peak field (300K)	> 50 MV/m
Maximum peak field (77K)	> 65 MV/m
Q ₀	Cu: 8600 Nb: 6000
RF pulse length	10 μs to continuous
Emission current	100 pA to 10 mA
Pressure	< 10 ⁻⁷ mb

Table I : Characteristics of the 1.5 GHz copper cavity

Two cavities of this model were constructed : # 1 with an isolated electrode (diameter 15 mm) placed in front of the sample allowing an accurate measurement of the electron current flowing from the sample inside a conical angle of 40°. The # 2 cavity is equipped with an optical viewport (sapphire window) taken the place of the current measuring electrode. Electron trajectories calculations give a maximum

electron energy of 100 keV for a surface field at the sample of 40 MV/m. Two permanent magnets were disposed on each side of the tube supporting the viewport in order to deflect the electron beam and avoid a strong bombardment of the sapphire window.

The cavity is powered by a 5 kW klystron (Thomson TH 2466) working in pulsed mode : frequency 1 Hz, pulse length 1 to 5 ms, to limit the dissipation on the cavity walls.

Two coaxial antennas are installed at the upper part of the cavity together with the vacuum pumping tube. An ion pump keeps a low pressure ($\leq 10^{-7}$ mbar) during the experiments.

The sample (diameter 3 mm, height 15 mm) is screwed on the lower part of the cavity. Its reduced size allows the mounting on a SEM special holder for examination and local measurements before (and after) the experiment in the cavity [7].

2 - THE OPTICAL SYSTEM AND ITS CALIBRATION

The cavity with its pump is directly assembled under an optical table where the complete experimental set up is mounted (Fig. 1). Two lenses (f : 200 and f : 450) give an image (x 2.2) of the sample at the focal plane where is placed a CCD camera (CoHu 4910) without any filter of window protection. The camera has a sensitivity of 0.02 lux and the calibration using a HeNe laser and calibrated attenuator gives a radiation sensitivity of 1.5×10^{-11} W at 630 nm.

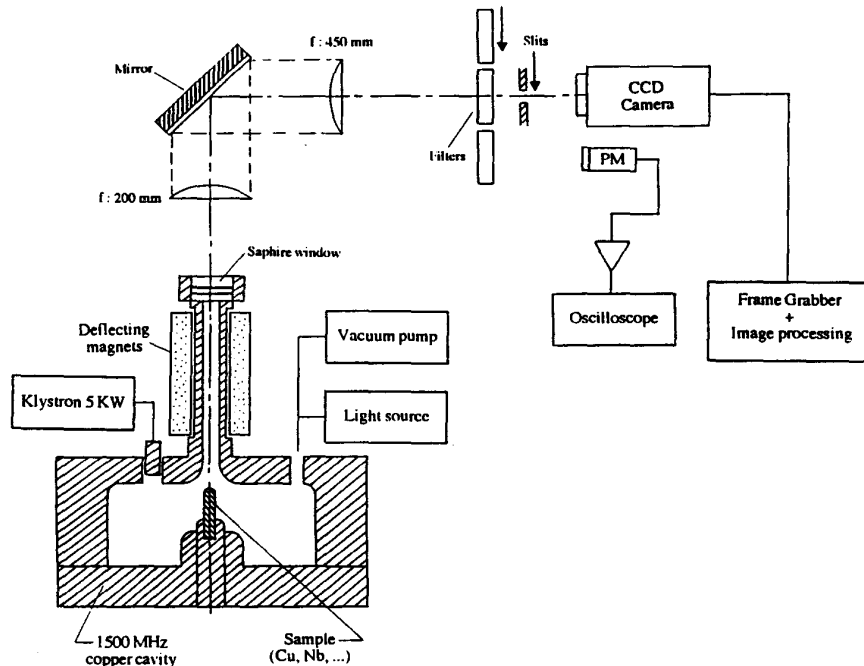

Fig. 1 : Optical system for light detection in RF cavities

Taking some precautions (averaging, offset balancing) it is possible to perform differential measurements of the light intensity integrated over the CCD sensor area with higher sensitivity, reaching 10^{-12} (the spectral response of the CCD sensor covers the wave length range : 400 - 700 nm - 50 % of relative response -). The video signal from the camera is sented to a Frame Grabber Board installed in a PC microcomputer. Image analysis software provides a simple and efficient tool to digitize and study the light emission phenomena on the sample.

Geometrical calibration of this optical system (lenses + mirror + camera) gives a final resolution of $3.6 \mu\text{m}$ at the sample level ($\approx 8 \mu\text{m}$ at the CCD sensor). This is in principle a quite satisfactory result to localize light spots on the sample surface, but the main problem remains the accurate marking of the sample for off-line observation and analysis.

The two lenses and the camera are positioned by DC motors and potentiometers for readout and remote control. The overall precision and reproducibility of these movements was evaluated to better than $50 \mu\text{m}$.

In some experiments a photomultiplier (Hamamatsu R4125) was placed at the focal plane. It detects either the total light coming from the sample (solid angle defined by the cavity hole and saphire window : 2.5×10^{-3} Sr) or the light through a slit (or square diaphragm) placed in face of the PM cathode, allowing the observation of a particular area of the sample.

The calibration of the PM with the same laser as described previously, gives a sensitivity of 2×10^{-13} W (corresponding to an anode current of 1nA) at 630 nm (the spectral response of the PM is limited for the IR : 350 - 550 nm - 50 % of relative response -).

3 - EXPERIMENTAL RESULTS

3.1 - Observations of light spots

The first observations of light emission with this cavity were made using a copper sample scratched with a tungsten point (Fig. 2). Examination with the SEM shows small outgrowths over the surface, mainly in the vicinity of the artificially located grooves.

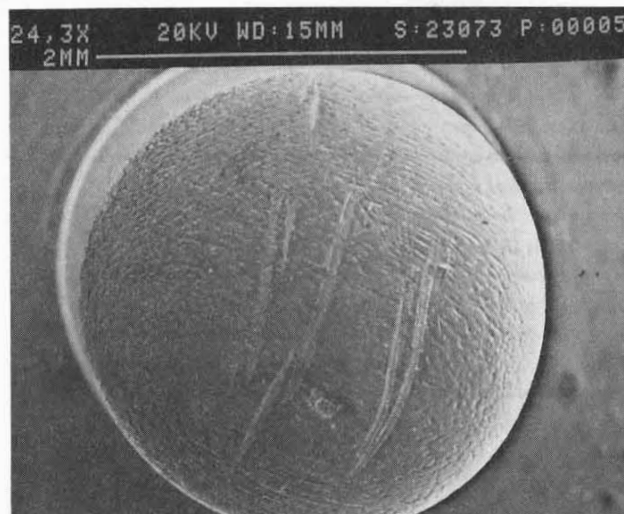

Fig. 2 : Copper sample (SEM picture)

After an initial RF processing (pulse frequency 1 Hz, pulse length 2 ms) the vacuum in the cavity was stabilized and it was possible to increase the electric field. The procedure of RF conditioning is described in details by J. Tan et al. in reference [6] [7].

Using the CCD camera a first spot was observed for $E = 43$ MV/m and pulse length of 2 ms and it was possible to observe a decreasing luminous intensity down to $E = 35$ MV/m but for lower values of the electric field the spot ceased to be visible. During this experiment it was necessary to increase the pulse length from 2 to 4 ms for a clear identification of the spot in the electrical field range between 35 MV/m and 40 MV/m.

Placing the photomultiplier (PM) at the focal plane, we have measured the total light coming from the sample. This time, a light signal was observed starting at lower fields $E \geq 20$ MV/m and when the field was increased an anode current step takes place for $E \geq 38$ MV/m with a slight hysteresis. All these results are plotted in Fig. 3 : the PM signal corresponding to the total anode current measured by the 15 mm diameter photocathode and the CCD signal corresponds to the maximum light intensity (arbitrary units) of the single spot. For the presentation of results we have chosen the experimental law : $I = f\left(\frac{1}{\sqrt{E}}\right)$. This law is adopted by

two authors [1] [3] proposing two completely different models : electro-luminescence and black body radiation. For the PM measurements this law seems to fit quite well but we cannot conclude before a more large number of tests so we have adopted it just for convenience of data presentation.

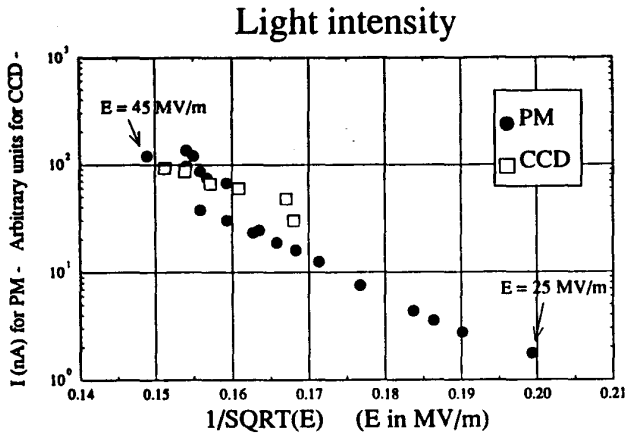

Fig. 3 : Light intensity vs Electric Field

The geometrical aspect of a light spot as viewed by the CCD camera is presented in Fig.4.

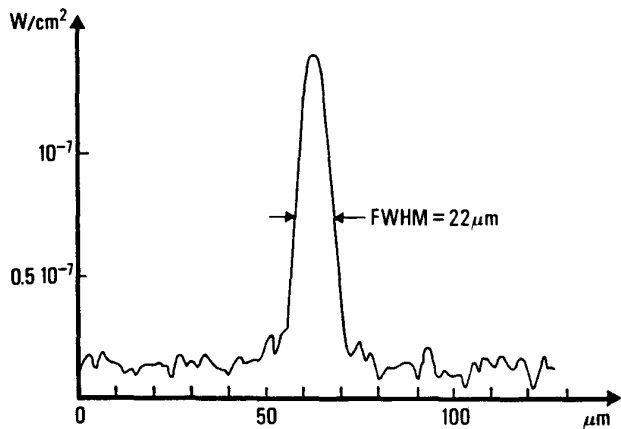

Fig. 4 : Transverse profile of a single spot observed with the CCD camera

The image processing software allows to obtain profiles of the light spot along an axis. The apparent size (at the level of the sample) is $20 \mu\text{m}$ (FWHM). Using the calibration of the sensors, we have evaluated the power in the spot : $P = 3 \times 10^{-10} \text{ W}$ (measured with the CCD camera). At the same electrical field the total light measured by the PM corresponds to a power of $1.5 \times 10^{-9} \text{ W}$, note that the wave length range covered by this sensor is shorter than the CCD.

During the experiment with this sample (several days corresponding to a real RF time of 10 minutes), five spots were observed but not simultaneously, the "optical life" of one

spot is evaluated to a few minutes after this time they disappear but can be turned on by increasing the field or the RF pulse length. All the observed spots lie in a ring around the axis of the sample, of radius $\approx 1 \text{ mm}$. This sample was controlled before and after the RF experiments, in a separate cavity (type # 1) equipped with an electrode for electron current emission measurement. The results are presented in Fig.5. The two Fowler-Nordheim plots are very close, the measured equivalent β remaining roughly the same.

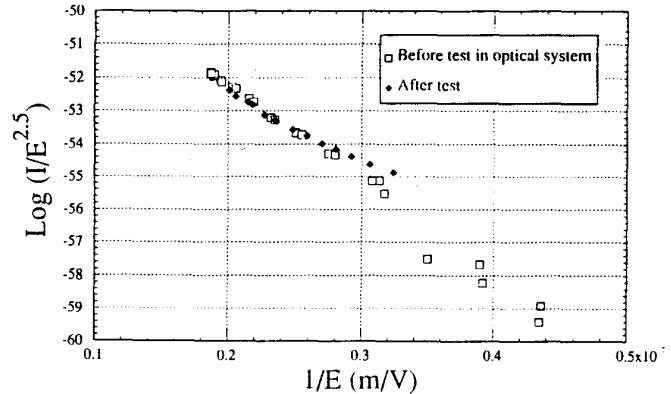
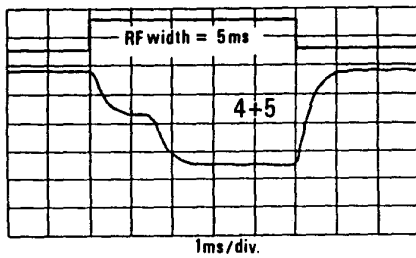
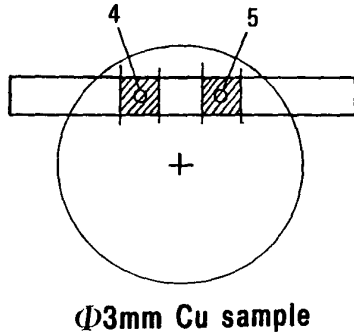

Fig. 5 : Fowler-Nordheim plots of the copper sample measured in a separate cavity

3. 2 - Time dependance of the light emission

When using a PM, it was possible to observe some interesting facts : the light signal (anode current) corresponding to the whole sample was slightly unstable during the experiment and depends strongly on electrical field and RF pulse length. With a RF pulse of 4 ms, a first plateau in synchronism with the RF was observed at low field. Increasing the field a second plateau of twofold intensity was observed, delayed by a time varying between 1 and 2 ms. This delay decreased progressively during the experiment to values less than 1ms.

In order to study in more details this transient effect, a slit assembly was installed just before the PM photocathode for observation of a particular area of sample. The vertical position of a horizontal slit (1 mm) was adjusted to measure the light coming from two spots (# 4, # 5). A vertical slit (1 mm) was added and its horizontal position adjusted to measure separately the spots # 4 and # 5. The PM anode signals are presented in the Fig.6. Each spot has a different transient behaviour and the signal corresponding to the horizontal slit alone gives with a good precision the sum of the two single spots.



1- Horizontal slit (1mm width)
off axis : $\Delta y = +0.9\text{mm}$

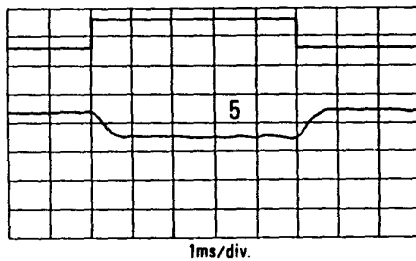

2- Square aperture (1mm side)
off axis : $\Delta x = +0.5\text{mm}$ $y = +0.9\text{mm}$
(corresponding to #5 spot area)

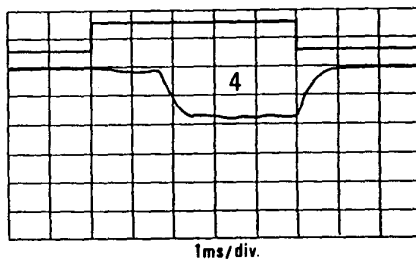

3- Square aperture (1mm side)
off axis : $\Delta x = -0.5\text{mm}$ $\Delta y = +0.9\text{mm}$
(corresponding to #4 spot area)

Fig. 6 : Light emission signals (PM) corresponding to different areas of the sample surface

A simple thermal model could explain this difference between the spots : different time delays for particles well isolated from the sample surface, to reach a temperature which allows a sufficient level of radiation power to be detected by the optical sensors.

3.3 - Light spectrum

Using a set of high pass filters (Melles Griot) covering the 500 nm - 850 nm range in steps of 50 nm, a preliminary study of the light spectrum from a single spot has been made using the CCD camera.

A typical spectrum of a single spot is presented in Fig. 7. This spectrum shows an important power starting at 600 nm and increasing toward the IR region. The CCD sensor has a reduced sensitivity for wavelengths greater than 850 nm but it was able to measure a significant power (35 % of the total power) in the interval 850 - 1000 nm. This measurement could be also explained by a simple thermal model but more detailed measurements and statistics are necessary to conclude on this point. In the Fig.7 a curve giving the black body radiation power of a particle ($T : 1500\text{ K}$) corresponding to the solid angle of the experiment roughly confirms the trend observed in this spectrum.

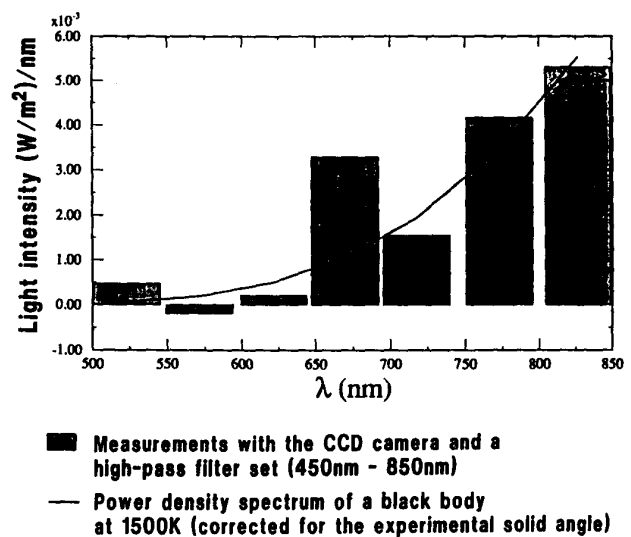

Fig. 7 : Spectral density distribution of a single spot (CCD measurement)

4 - CONCLUSION AND FURTHER IMPROVEMENTS

These preliminary results confirm that the main objective of this work was reached : the working principle of this kind of diagnostic has been proved. Light spots were clearly observed but an important question remains to be answered by complementary experiments : are all the observed light spots candidates for field electrons emission sites ?

The simultaneous measurement of light emission and emitted current from the sample can be obtained by electrical insulation of the central part of the cavity supporting the removable sample. This improvement is under development and it can partially contribute to answer the question.

Some DC field emission experiments can also be performed after the RF tests : localised light spots with the optical detection system can be measured by a special anode probe mounted on the SEM sample chamber. This operation asks for an accurate marking of the sample in order to position the spots with a good reproducibility in the two separate experiments.

Concerning the spectrum measurement some improvements can be easily performed : installation of a monochromator associated with a sensitive photomultiplier must give an order of magnitude increase in the wavelength resolution as compared to the high pass filter method.

Finally, increasing the sensitivity of the optical detectors can give an answer to another important question : is the black body radiation the main mechanism of light emission in a RF cavity ? Some authors have reported electroluminescence in DC experiments and the presence of this phenomena in RF cavities remains an open question.

AKNOWLEDGEMENTS

We are grateful to Sophie MAÏSSA for her contribution to the calibration of the optical detectors.

We thank all the members of the group "GECS" at Saclay and Orsay for their continuous help and support

REFERENCES

- [1] R.F. HURLEY and P.J. DOOLEY,
J. Phys. D : Appl. Phys. 10 (1977) L 195,
- [2] R.E. HURLEY,
J. Phys. D : Appl. Phys. 13 (1980) 1121
- [3] Ph. BERNARD et al.,
NIM 190 (1981) 257
- [4] M. JIMENEZ et al,
DAPNIA/SEA 93-02 (CE Saclay) and to be published
in J. Phys. D.
- [5] R. NOER (6th Workshop)
- [6] J. TAN, H. SAFA et al, submitted to J. Phys. D.
(Oct. 93),
- [7] B. BONIN et al. (6th Workshop).