

Operation of the S-DALINAC, related Topics and Developments*

M. Brunken, S. Döbert, H. Genz, M. Gopych, H.-D. Gräf[#], S. Khodyachykh, S. Kostial, U. Laier, H. Loos, A. Richter, S. Richter, B. Schweizer, A. Stascheck, O. Titze, IKP, TU Darmstadt, Schlossgartenstr. 9, D-64289 Darmstadt, R. Eichhorn, GSI, Planckstr. 1, D-64291 Darmstadt.

Abstract

A review of the operation of the S-DALINAC's sc cavities over the last two years shows two occasions of severe Q degradation. The reasons and the curing measures taken are discussed. Besides the routine operation of the accelerator, improvements and developments with respect to its beam dynamical properties and diagnostics equipment were performed. A study showed that a nonisochronous recirculation scheme offers improved longitudinal stability and thus reduced energy spread of the beam. Therefore conversion of the recirculating beam transport system from isochronous to nonisochronous operation has been performed for two of the four arcs and will be completed in spring 2000. Also some of the beam transport sections were modified in order to increase their acceptance and to improve their tolerance versus field errors. A non destructive monitoring system for beam intensity and position has been completed. Extremely compact, mechanically simple, low Q ($Q < 1000$) rf cavities, made from stainless steel are used as detectors. Their response is fast enough to resolve individual bunches and thus individual passes of the beam through the linac in case of the subharmonic 10 MHz time structure. This is used frequently, not only for the FEL but also for electron scattering experiments to allow for very efficient background suppression by time of flight analysis. When used for a beam with 3 GHz cw time structure the rather low sensitivity of the monitors is compensated by using lock-in technique in the signal analysis.

1 INTRODUCTION

The S-DALINAC [1] is a sc electron accelerator having been developed and being used in the environment of a university for research in low energy nuclear and radiation physics. Its design parameters are summarized in Tab. 1.

Since 1987 the S-DALINAC has delivered some 20.000 hours of beam time for a large variety of experiments which are listed in Tab. 2. The requirements on the electron beam parameters differ very much, i.e. continuous 3 GHz electron beams with energies between 2.5 and 120 MeV and intensities from 1 nA to 50 μ A have been produced as well as high intensity beam with a 10 MHz time structure for Free-Electron-Laser (FEL) [2] operation.

New experiments are planned which will further expand the range of the parameters. For optimizing the beam quality under the very different conditions of every single experiment it was and still is necessary to improve beam diagnostics and dynamics as well as the properties of the superconducting niobium cavities. It has been experienced that investigations and new developments for a single experiment may improve the quality of experimental results in completely different fields by synergy effects. Some special topics and results of the last two years of S-DALINAC operation are reported here.

Table 1: Design Parameters

max. Beam Energy	130 MeV
Energyspread	$\pm 10^{-4}$
max. Current	20 μ A
Dutycycle	cw
Material	Niobium (RRR=300)
Frequency	2.9975 GHz
Temperature	2 K
Quality Factor	$3 \cdot 10^9$
Accelerating Gradient	5 MV/m
RF Losses at 5 MV/m	4.2 W

Table 2: Beam Parameters

Experiments	Energy (MeV)	Current (μ A)	Mode	Time (h)
(γ, γ)	2.5 – 10	50	3 GHz, cw	6400
LEC, PXR	3 – 10	0.001 - 10	3 GHz, cw	2100
HEC, PXR	35 – 87	0.1	3 GHz, cw	800
(e, e ₋), (e, e _{-x})	22 – 120 ¹⁾	5	3 GHz, cw	7800
FEL	30 – 38	2.7 A _{peak}	10 MHz, cw	2900
1) Dutycycle 33%				Σ 20000

Resolution: $\Delta E_{FWHM} = 50$ keV @ 85 MeV, $\Delta E/E = \pm 3 \cdot 10^{-4}$

Following a brief description of the accelerator in Sec. 2 we turn to properties of the sc cavities in Sec. 3. Improvements of beam dynamical properties and diagnostics equipment are covered in Sec. 4 and 5 respectively, while Sec. 6 explains the benefits of the 10 MHz time structure of the beam for nuclear physics experiments.

* Work supported by BMBF under contract number 06 DA 820 and DFG under contract number RI 242/21-1 and -2 and through the Graduiertenkolleg 'Physik und Technik von Beschleunigern'.

[#] E-mail: graef@ikp.tu-darmstadt.de

2 S-DALINAC

The principle of operation of the superconducting recirculating electron accelerator S-DALINAC is illustrated by the layout shown in Fig. 1. The electrons are emitted by a thermionic gun and then accelerated electrostatically to 250 keV. The required time structure of the electron beam for rf acceleration in a 3 GHz field is prepared by a chopper/prebuncher system operating at room temperature. The sc injector linac consists of one 2-cell, one 5-cell, and two standard 20-cell niobium structures, the parameters of which are also summarized in Tab. 1. The maximum electron energy behind the injector linac is 10 MeV. The electron beam can either be delivered to radiation physics or nuclear resonance fluorescence experiments or bent isochronously by 180° for injection into the main linac consisting of eight 20-cell cavities, and reaching a maximum energy gain of 40 MeV per pass. Thus, using two recirculations, a maximum electron energy of 130 MeV can be achieved. The electron beam can be used for different types of experiments such as high energy radiation physics or electron scattering experiments in two electron spectrometers. Additionally, in the first recirculation beamline, the FEL experiment is located and can make use of the electron beam with 50 MeV maximum energy.

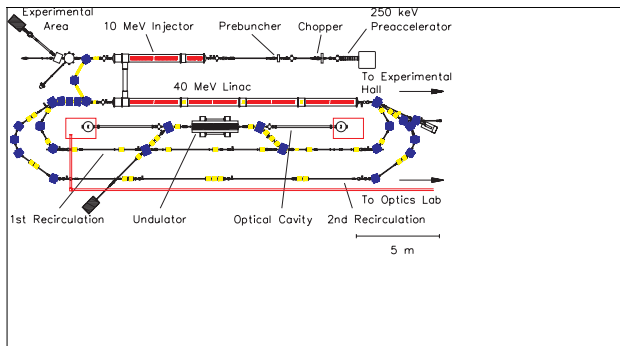

Figure 1: Layout of the S-DALINAC.

3 ACCELERATING CAVITIES

The design parameters of the S-DALINAC assumed for the 1 m long, 20-cell cavities an accelerating gradient of $E_{acc} = 5$ MV/m and an unloaded Q of $Q_0 = 3 \cdot 10^9$. For the gradient this seemed rather challenging in the late 70s, the figure for Q_0 seemed reasonable, even though it is less than a factor of two below the BCS limit for a 3 GHz cavity at a temperature of 2 K. Operation of the S-DALINAC over almost ten years now has shown that all of the installed cavities easily exceed 5 MV/m. On the other hand has none of them yet reached $Q_0 = 3 \cdot 10^9$ when installed in the accelerator. With different kinds of preparation techniques we reached figures of, or slightly exceeding $1 \cdot 10^9$.

In order to find the reason for this still unexplained phenomenon we have set up an external vertical 2 K cryostat which allows us to perform systematic studies

without interfering with accelerator operation. It is planned to use ‘first generation’ (low RRR) cavities and in a later stage of the project also the two spare cavities of the S-DALINAC as samples. One goal is the development of a magnetic shielding, optimized for the complicated geometry of a ‘real world’ cavity, equipped with tuner, rf couplers, and beam tubes. Separately we intend to take a systematic second look into the application of well proven chemical, mechanical, and thermal preparation methods. Since the slim geometry of a 3 GHz, 20-cell cavity is rather unfavorable for any preparation method, it might turn out that we need modifications in the application of the different preparation techniques.

We want to devote at least one paragraph to a phenomenon which struck us in 98 through a partial, though dramatic decrease of Q_0 . The development is illustrated by the bar diagram in Fig. 2. There, four bars, indicating Q_0 , are shown for each cavity of the S-DALINAC main linac (numbers 4 – 11). The left bar of each group indicates the situation early in 98. A few months later the helium refrigerator needed maintenance and had to be warmed up. We decided to leave the accelerator cryostat at an intermediate temperature of some 120 K. During this partial warmup the pressure in the insulating vacuum region increased to 20 mbar for 2 – 3 hours (later it turned out that this was due to nitrogen which had leaked from the thermal radiation shield and had been frozen out on the outside of the helium vessels). At the same time the pressure in the beam tube rose to the 10^{-6} mbar range for 20 minutes and then dropped to its usual value of 10^{-8} mbar. Several days later, when the cavities were again at 2 K, we observed the dramatic change in the Q_0 values, indicated in Fig. 2 by the second bar from the left in each group. Cavities 6, 8, 9, and 10 were strongly affected, the others showed no significant change in Q_0 .

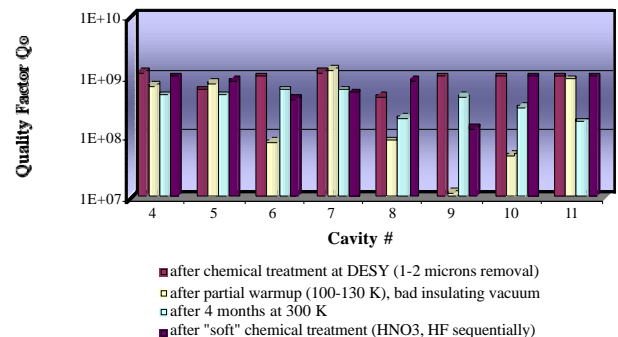

Figure 2: Quality factor Q_0 of the main accelerator cavities.

Expecting leaks, at least at cavities 6 and 9, the cavities were warmed up to room temperature, but no leaks could be found in the expected locations, however two small leaks between insulating vacuum and cavity vacuum were

found at the rf input lines of cavities 5 and 10. A shutdown period of four months during which the cavities remained at room temperature followed and after the next cooldown a different, more homogenous distribution of Q_0 (indicated by the third bar of each group) had established. During the successive warmup the beam vacuum was monitored by a residual gas analyser, but no sign of a contamination escaping from the cavities could be detected. In the meantime we have chemically treated cavities 4, 5, 8, 9, 10, and 11, removing extremely little niobium by applying HNO_3 and HF sequentially. The right bars of each group in Fig. 2 show the result: the cavities (except cavity 9) recovered their original performance (cavities 6 and 7 of course remained unchanged since they were not treated). This, in our opinion, excludes the possibility of a hydrogen problem since no thermal treatment was applied. Therefore there is no convincing explanation for the observed phenomena yet.

4 BEAM DYNAMICS

A review of the longitudinal as well as the transverse beam dynamics in the two recirculating beam lines of the S-DALINAC clearly indicated possible improvements. Longitudinally the recirculation scheme was isochronous. Following the considerations of H. Herminghaus [3] we investigated numerically to which extent a deviation from the isochronous scheme could be beneficial. It turned out that even in the special situation of the S-DALINAC (only two recirculations and only three passes through the linac) the influence of amplitude- and phase jitter on the energy spread of the beam can be suppressed considerably. The combination of a synchronous phase of -9.5° and a longitudinal dispersion of $r_{56} = -1.5 \text{ mm}/\%$ still ensures an energy spread of $(\Delta E/E)_{\text{FWHM}} = 10^{-4}$ even if an amplitude jitter of $\pm 10^{-3}$ for the accelerating fields in the main linac is assumed.

The longitudinal dispersion can be generated symmetrically in both arcs of each recirculating beam line by modifications of the respective quadrupole lattices. Beam transport in the straight sections is kept dispersion- and angular dispersion free. In order to obtain experimental proof for the result of the numerical simulations we used the existing quadrupole lattices with modified settings to approximate the non isochronous situation. The electron beam, after passing through a momentum defining slit system, was analysed with respect to its energy distribution in an elastic scattering experiment, using a magnetic spectrometer. The result of this test is shown in Fig. 3, where the line width of the elastically scattered electrons is plotted versus the setting of the slits, expressed as transmission through the slit system. It is obvious that in the isochronous case the energy spread of the beam increased when the width of the slits was increased, whereas it remained constant in the non isochronous case (which means that the energy spread of

the beam was indeed smaller, when accelerated in the non isochronous scheme).

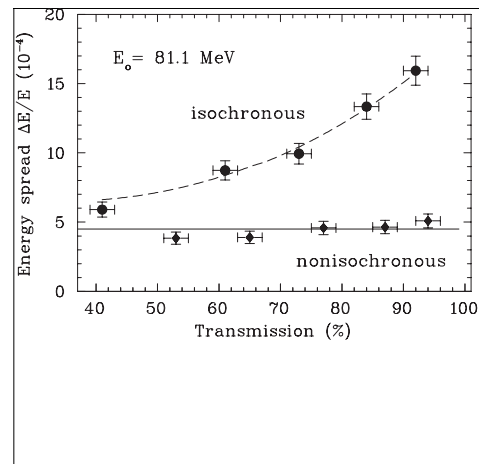

Figure 3: Experimental test of longitudinal beam dynamics.

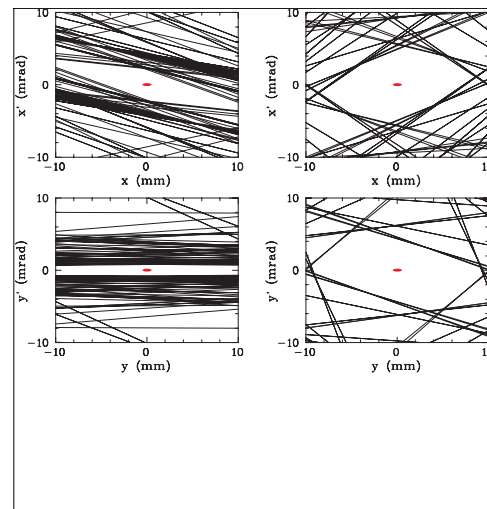

Figure 4: Transverse properties (acceptances) of the first recirculation beam transport system. The ellipse indicates a typical beam emittance.

The transverse properties of the straight sections of the recirculating beam lines, each consisting of two quadrupole doublets and one triplet were investigated systematically with respect to their acceptance and their tolerance versus field errors (e. g. due to remanent fields). Figure 4 shows transverse phase space plots for the first recirculating beam line. The free area bounded by the straight lines (limits of the acceptance for each beamline element) represents the acceptance, the little ellipse in the center indicates a typical emittance of the beam. It is obvious that a FODO arrangement of the seven quadrupoles in the straight section (right part of Fig. 4) has strong advantages over the dublett – triplet – dublett arrangement shown in the left part of Fig. 4. We have

therefore already modified the quadrupole lattice in the beam line of the first recirculation (arcs and straight section). Conversion of the second recirculation is scheduled for a shutdown in spring 2000.

5 BEAM DIAGNOSTICS

A combination of 3 GHz rf cavities has been developed to obtain non destructive online diagnosis of beam intensity and position in different locations. Requirements were that the cavities had to be compact and mechanically simple. They had to have good UHV properties and should be rather insensitive to ambient temperature changes of $\pm 2^\circ\text{C}$, in order not to need tuning devices or temperature stabilization. The result is a combination of cylindrical TM_{010} – and TM_{110} cavities as shown in Fig. 5. The cavities are fabricated from stainless steel, they have a common center piece and two covers which connect to the beam line. The rf outputs use ceramic feedthroughs. All seals are standard CF copper gaskets, except one which differs in diameter. The cavities are operated at loaded Qs of less than 1000, which ensures that no frequency tuning is required.

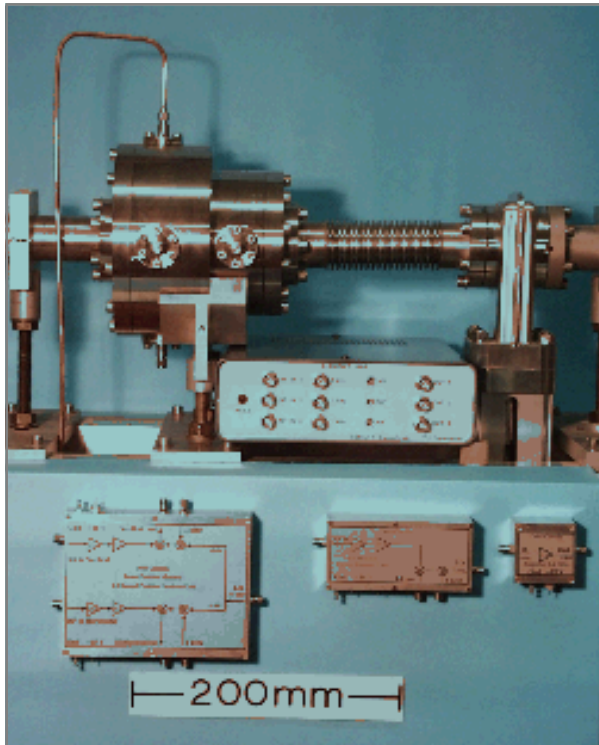

Figure 5: Non intercepting 3 GHz rf monitors with microwave and low frequency electronic components for signal processing.

The resulting sensitivities amount to $15 \text{ nW}/(\mu\text{A})^2$ for the intensity monitor and to $15 \text{ pW}/(\text{mm } \mu\text{A})^2$ for the position monitor. For signal processing the electronics shown in Fig. 6 were developed. Lockin technique is used to compensate for the rather low sensitivities of the rf

cavities. Using an effective bandwidth of 1 Hz, changes of the beam current of 10 nA or 0.1 mm in position (at a current of $1 \mu\text{A}$) are clearly detectable. Monitors have been installed in front of the injector linac, behind the main linac, at the beginning and at the end of the straight sections of both recirculations, and in the beam line to the experimental hall. It should be noted that due to their low Q, the response of the cavities is fast enough to resolve bunches with a time separation of 100 ns (see Sec. 6). Therefore the monitor behind the main linac (equipped with fast electronics) is able to provide ‘self calibrated’ information on all three passes of the beam, since the bunches are not spacially overlapped in this mode of operation.

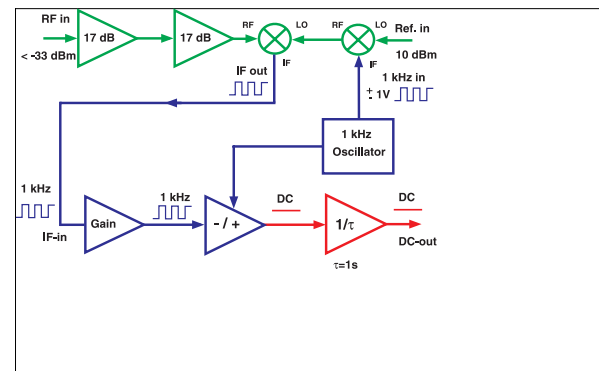

Figure 6: Signal processing for one channel of the monitor station shown in Fig. 5.

6 ALTERNATIVE USE OF 10 MHz TIME STRUCTURE

Inclusive electron scattering experiments are very sensitive to radiation background reaching the magnetic spectrometers. The background photons are produced as bremsstrahlung when parts of the electron beam hit material for example from the beam tubes or energy defining slits. It has been shown at the S-DALINAC that the radiation background can be reduced up to one order of magnitude using the 10 MHz time structure of the electron beam being originally developed for the FEL operation. In this mode the electron bunches are separated by 100 ns or 33 m. Within one separation length there is a definite relation between spatial coordinate of the electron and the time of flight since its emission from the electron gun. That means, all electrons scattered from the investigated target reach the detector system of the spectrometer at a fixed time with respect to the timing signal of the gun pulse. Figure 7 shows a time of flight spectrum of electrons measured in the detector system of the Q-Clam spectrometer at the S-DALINAC during a scattering experiment on the ^{90}Zr nucleus. The incident electron energy was 66.4 MeV and the scattering angle detected with the spectrometer 180° with respect to the incident beam direction. This was possible by using the special beam transport system for 180° scattering at the S-

DALINAC [4]. The time spectrum shows that only a part of the detected events result from scattering of an electron from the target. Other events are created from photons being created in the 40° energy defining magnet system several meters upstream of the scattering chamber and from electrons backscattered from the beam tube in the vicinity of the refocussing quadrupoles and the faraday cup downstream of the target. By cutting off the events not resulting from scattering from the target the background can be reduced drastically which improves the quality of the experimental data.

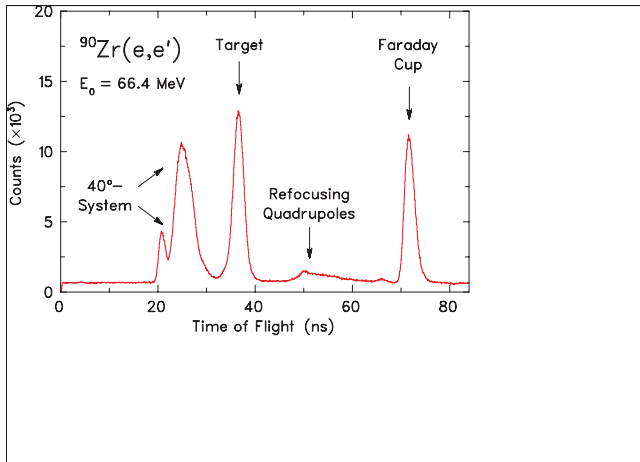

Figure 7: Time of flight spectrum for 180° scattering.

7 CONCLUSION

For the S-DALINAC considerable improvement was achieved with respect to the beam dynamical properties of the two recirculating beamlines. In addition, 3 GHz rf cavity monitors and the necessary electronics for non destructive monitoring of the beam intensity and position have been developed and are incorporated in the accelerator at seven locations. For efforts, necessary to improve on the unloaded Q of the accelerator's sc cavities, an external 2 K cryostat has been set up, to allow for systematic studies without interfering with accelerator operation.

8 ACKNOWLEDGEMENT

We are very much indebted to H. Lengler for his continuous interest and support throughout the development of our accelerator. We have always benefitted from stimulating discussions with B. Aune, D. Bloess, E. Haebel, A. Matheissen, D. Proch, H. A. Schwettmann, and T. Weiland and are grateful for their contributions. The tremendous help from many colleagues at DESY, particularly from A. Matheissen and D. Reschke with the treatment of our sc cavities is gratefully acknowledged.

9 REFERENCES

- [1] A. Richter, Proc. 5th Europ. Part. Acc. Conf., Eds. S. Myers, A. Pacheo, R. Pasual, Ch. Petit-Jean-Gena, and J. Poole, Sitges (Barcelona), (1996) 110.
- [2] M. Brunken, S. Döbert, R. Eichhorn, H. Genz, H.-D. Gräf, H. Loos, A. Richter, B. Schweizer, A. Stascheck, T. Wesp, Nucl. Instr. Meth. **A429** (1999) 21.
- [3] H. Herminghaus, Nucl. Instr. Meth. **A305** (1991) 1.
- [4] C. Lüttge, C. Hofmann, J. Horn, F. Neumeyer, A. Richter, G. Schrieder, E. Spamer, A. Stiller, D. I. Sober, S. K. Matthews, L. W. Fagg, Nucl. Instr. Meth. **A366** (1995) 325.