

POSITRON INJECTOR ACCELERATOR AND RF SYSTEM FOR THE ILC*

J. W. Wang[#], C. Adolphsen, V. Bharadwaj, G. Bowden, E. Jongewaard, Z. Li,
R. Miller, J.C. Sheppard
SLAC, Menlo Park, CA94025, U.S.A.

Abstract

Due to the extremely high energy deposition from positrons, electrons, photons and neutrons behind the positron target, and because a solenoid is required to focus the large emittance positron beam, the 1.3 GHz pre-accelerator has to use normal conducting structures up to energy of 400 MeV. There are many challenges in the design of the normal-conducting portion of the ILC positron injector system such as obtaining high positron yield with required emittance, achieving adequate cooling with the high RF and particle loss heating, and sustaining high accelerator gradients during millisecond-long pulses in a strong magnetic field. Considering issues of feasibility, reliability and cost savings for the ILC, the proposed design for the positron injector contains both standing-wave (SW) and traveling-wave (TW) L-band accelerator structures. A short version of the new type of the SW section is under fabrication and testing, an updated status report is given. This paper also covers the acceleration vs. deceleration for pre accelerator sections, SW vs. TW structures, as well as the longitudinal matching from target to linac and linac to damping ring.

INTRODUCTION

The positron source relies upon an intense source of high energy photons impinging upon a metal target. The photons must be of sufficient energy, typically of order 10 MeV, to generate electron-positron pairs that can escape from the target material and be captured and accelerated. The photons are generated by synchrotron radiation in a helical undulate through the interaction of relativistic electrons with a periodic, helical, magnetic field. The photon beam is incident on the rim of a rotating target of thickness 0.4 radiation lengths contained in a vacuum vessel. Approximately 24 kW of power from the photon beam is deposited in the target in a spot of ~ 1 mm rms. The resulting electron/positron particles emerging from the downstream side of the target are captured in a 0.09 m-rad transverse dynamic aperture. The energy of the beam coming out of the target is 2-10 MeV. The target is followed by the tapering magnetic field of an Optical Matching Device (OMD) which has a field which decays from 5-0.5 T over 20 cm. The OMD is used to match the beam phase space coming out of the target into the capture L-band RF. The capture RF is placed after the target and OMD and accelerates the beam to 125 MeV.

*Work supported by U.S. Department of Energy, contract DE-AC02-76SF00515 (SLAC).

[#] jjwap@slac.stanford.edu

ACCELERATOR SYSTEM LAYOUT

The capture region is composed of two 1.27 m SW accelerator sections at 15 MV/m accelerating gradient and three 4.3 m TW accelerator sections at 8.5 MV/m accelerating gradient in order to capture and accelerate the electron beam to 125 MeV as shown in Figure 1.

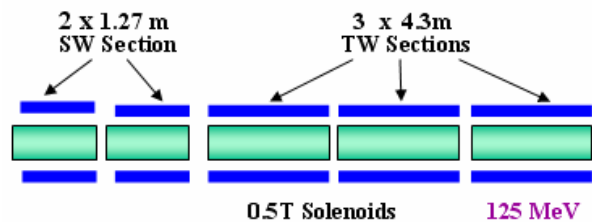

Figure 1: Schematic layout of the capture region.

The electrons are accelerated from 125 MeV to 400 MeV in a pre-accelerator region, which is composed of eight 4.3 m TW sections at 8.5 MV/m accelerating gradient. All accelerator sections are surrounded with 0.5 T solenoids as shown in Figure 2.

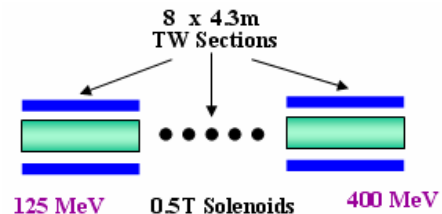

Figure 2: Schematic layout of the pre-accelerator region.

SW ACCELERATOR STRUCTURE FOR POSITRON CAPTURE

The high gradient (15 MV/m) positron capture sections have been designed to be simple π mode 11 cells SW type of accelerator structures. The advantages are a more effective cooling system, higher shunt impedance with larger aperture (60 mm), lower RF pulse heating, apparent simplicity and cost savings. The mode and amplitude stability under various cooling conditions for this type of structure have been theoretically verified. Figure 3 shows a cutoff view of the SW structure and Table 1 gives the important RF parameters.

Table 1: Parameters of SW structure.

Structure Type	Simple π Mode
Cell Number	11
Aperture $2a$	60 mm
Q	29700
Shunt impedance r	34.3 M Ω /m
E_0 (8.6 MW input)	15.2 MV/m

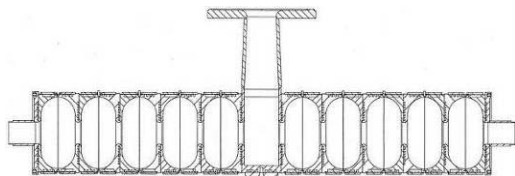

Figure 3: 11-cell SW structure.

TW ACCELERATOR STRUCTURE FOR PRE-ACCELERATOR REGION

All TW sections are designed to be 4.3 m long, $3\pi/4$ mode constant gradient accelerator type of accelerator structures. The RF group velocity for traditional $2\pi/3$ mode traveling wave structure is too high for our larger apertures (the ratio of iris radius with wavelength $a/\lambda \sim 10\%$) to obtain a good RF efficiency. Therefore, to increase the “phase advance per cell” was used to optimize the RF efficiency for designing this type of large aperture TW structure. Comparing with some standing wave structures, the advantages are lower pulse heating, easy installation for long solenoids, no need to use circulators for RF reflection protection, apparent simplicity and cost saving. Figure 4 shows the shapes for three typical cells of the TW structure and Table 2 gives the important RF parameters.

Table 2: Parameters of TW structure.

Structure Type	TW $3\pi/4$ Mode
Cell Number	50
Aperture $2a$	46 mm
Attenuation τ	0.98
Q	24842 - 21676
Group velocity V_g/c	0.62% - 0.14%
Shunt impedance r	48.60 - 39.45 M Ω /m
Filling time T_f	5.3 μ s
Power Dissipation	8.2 kW/m
E_0 (8.6 MW input)	8.0 MV/m

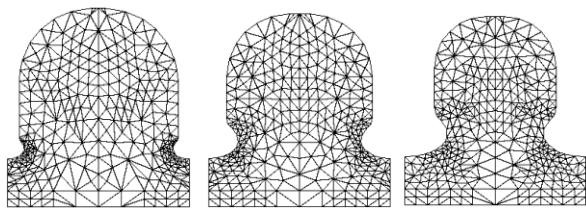
Figure 4: Profiles of the first, middle and last cell for 4.3m $3\pi/4$ Mode TW structures.

RF SYSTEM

Each accelerator section is equipped with an individual RF station powered by a 1300 MHz, peak power 10 MW pulsed klystron. The RF station is composed of modulator, RF windows, phase shifters, RF loads, directional couplers and low-level RF system. For the SW structures, RF circulators are needed for reflection protection of the high-power klystrons.

TEST STRUCTURES AND EXPERIMENT PLAN

In order to gain the fabrication experience and make high power tests at full gradient and pulse length with an existing 5 MW peak power L-Band klystron, we have designed a 5-cell L-Band test structure with coupler cell at one end and all necessary features for positron capture section as shown in Figure 5.

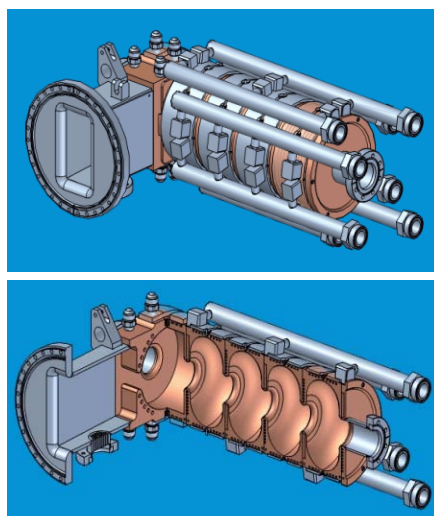

Figure 5: A 5-cell L-Band SW test accelerator section for the positron capturing structure - external view (top) and cut-away view (bottom).

At present, all structure components and sub-assemblies have been completed and microwave measured. The measurement accuracy and repeatability were carefully studied. The frequency tolerances are within 100 kHz. Two L-Band windows have been completed. They are checked, coated and delivered for high power test. The final assembly and high power test will be done in the first half of 2007. Figure 6 shows some important sub-assemblies.

Cooling channels are machined into the outer cylindrical surface and the planar end surface of the copper body. A copper cover is brazed over the planar end surface and a stainless steel cylinder brazed to the cylindrical outer surface of the copper body. A full cell is formed by brazing two of these half cell assemblies together at the cavity iris and the full accelerator section is assembled from these full cell subassemblies. To determine the operating temperature and the expected

tuning changes, an axisymmetric representation was modeled using the general purpose finite element code ANSYS. Cavity surface RF losses were calculated using the code Omega3P, a finite element parallel eigensolver developed at SLAC. A series of transient cases using the steady state temperature field as initial conditions were run to determine the temperature excursions during the RF pulse for the conditions of only RF heating and RF heating plus particle heating.

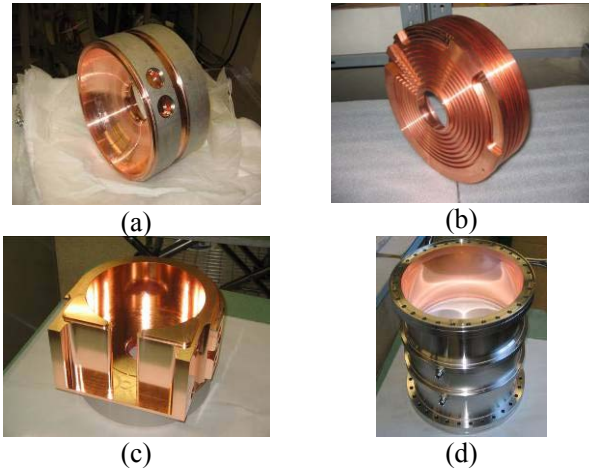

Figure 6: Some of the subassemblies for the 5-cell SW structure: a completed unit cell (a), a half cell to be brazed on the input coupler (b), coupler subassembly (c) and L-Band RF window (d).

SOME BEAM DYNAMICS STUDIES

A lot of beam dynamics studies were done for the design of conventional positron source. Their results may still be useful for the Keep Alive Source (KAS) for present undulator based reference design. The KAS is designed to deliver a low intensity (~10%) beam of positrons at 400 MeV to the positron booster linac in case the primary positron beam is unavailable. It uses a 500 MeV electron beam impinging on a tungsten-rhenium target to produced positrons in electromagnetic showers. The positrons are captured, separated and accelerated to 400 MeV using the same scheme as for the primary positron beam.

There are two approaches to the problem of capturing positrons: the acceleration capture and capture with initial deceleration. The traditional approach has been to arrange the phase and amplitude of the fields in the capture section(s) to accelerate the positrons as fast as possible. For this approach the higher the accelerator field the better because the higher the field, the more rapidly the velocity variation with energy becomes insignificant, and the less the beam debunches because of the initial energy spread of the positrons. At 1.3 GHz to get reasonable positron yield into a 15 degree bunch for acceleration in the linac requires an accelerating gradient of greater or order of 12 MeV/m.

In the 1970’s at SLAC an alternative approach was discovered which significantly improved the yield of our positron source. This approach involved initially decelerating the positrons and arranging the phase and amplitude of the fields so that the distribution in longitudinal phase space of the incoming positrons lay along one of the orbits in longitudinal phase space as shown in Figure 7. Thus the positrons approached a small spread in asymptotic phase as their energy increased.

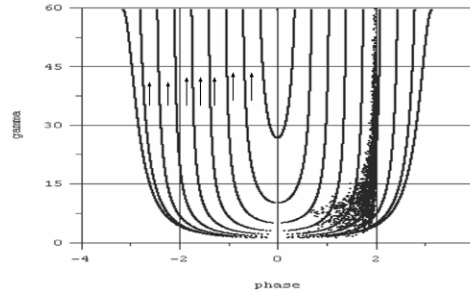

Figure 7: Phase space for positrons entering accelerator.

Simulations indicate that this approach can increase the yield of positrons into a 1% spectrum at 5 GeV by about 50%. These simulations were done without bunch compression. The optimum gradient in these capture-with-deceleration simulations was found to be about 6 MeV/m, a very comfortable gradient for the 1.3 GHz structure with ms long pulses inside a strong solenoid. With a gradient of 6 MeV/m a single 10 MW klystron can drive up to 6 meters of structure. Consequently, for deceleration capture, it makes sense to use a travelling wave structure for the capture section.

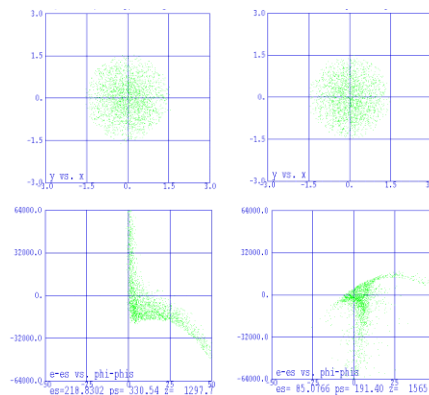

Figure 8: Plots to show transverse profile and phase space of captured beam for acceleration case (left) and deceleration case (right).

REFERENCES

- [1] V. Bharadwaj, et. al. “Design issues for the ILC positron source”, PAC2005, SLAC-PUB-11690.
- [2] J.W. Wang, et. al. “Studies of Room Temperature Accelerator Structures for the ILC Positron Source”, PAC05, SLAC-PUB-11767.
- [3] B. Aune, R. Miller, “New Method for Positron Production at SLAC”, LINAC1979, SLAC-PUB-2393.