

GANIL RF SYSTEMS : CAVITIES, TRANSMITTERS AND COUPLING SYSTEM.

C. BIETH, B. DUCOUDRET, G. DUGAY, A. JOUBERT, F. LABUSSIÈRE, S. KWIATKOWSKI.*

GANIL (Grand Accélérateur National d'Ions Lourds) BP 5027 14021 CAEN Cédex (France) tel (31) 94 81 11
Telex : 170533 F.

* Uniwersytet Warszawski, Instytut Fizyki Doświadczalnej WARSZAWA (Poland)

Abstract.— The mechanical outline of the GANIL's cavities is described and the latest experimental measurements on the resonator number one, tested in a separated vacuum chamber in the frequency range from 6 to 14 MHz are given. Results and performance of the 100 kW RF transmitter associated with the coupling system are presented.

1. Mechanical description.— The final mechanical and RF characteristics were determined on a one third scale model. Some modifications were adopted to correct the frequency range and to reduce the current density on the movable contact finger stock⁽¹⁾.

With the two stems connected on a common short circuit plate, the resonator can be constructed as a plug-in unit, including the outer copper conductor. So, for initial tests the RF structure can be housed in a dummy vessel. In order to obtain good mechanical tolerances the copper is sustained (dee and stems) by a rigid stainless steel structure Fig.1.

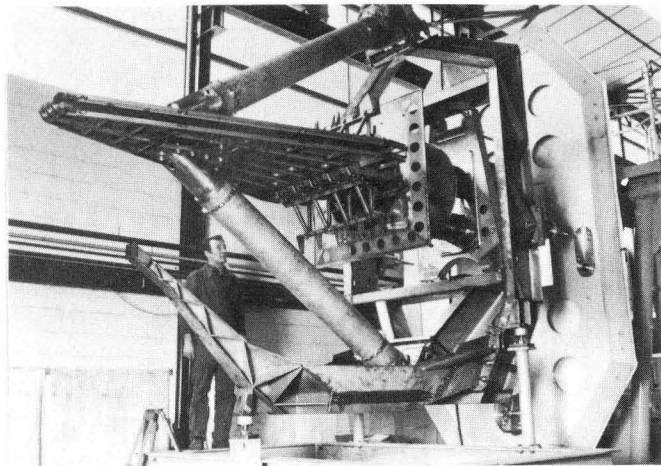

Fig. 1 : Dee and Stems stainless steel structure.

The water cooling tubes are soldered inside the dee, and also the stems after they were rolled from a sheet copper and welded longitudinally. The "waved" panel on the dee is fixed on the stainless steel structure but all the copper surface of the dee is radially free in such way that the thermal expansion does not affect the capacity gap Fig.2.

The external copper wall, divided in four removal part, is supported by an adjustable stainless structure which permits to obtain a precise position between the dee and the anti dee in the vertical direction. All these structures are connected to a support which can be adjusted to put the resonator in the median plane of the cyclotron under vacuum.

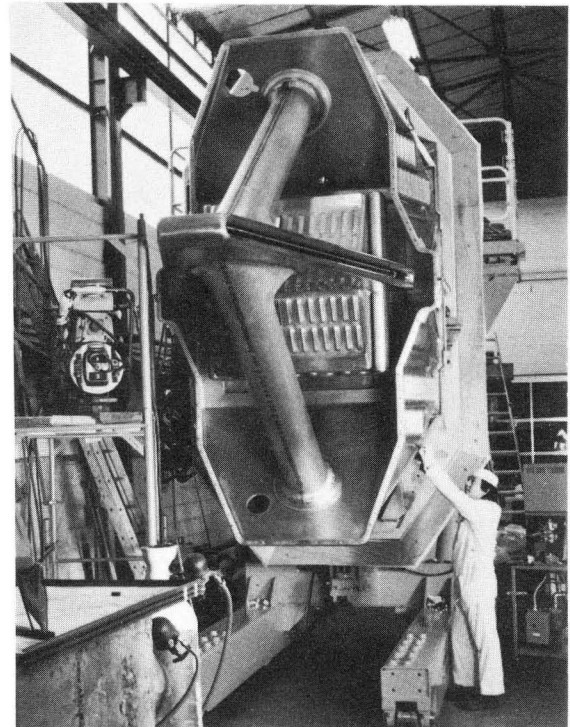

Fig. 2 : Dee and Stems.

At the rear of the resonator the vacuum door and then the RF amplifier plate-forme are fixed on a chariot. When the resonator is removed from the vacuum chamber, it is first fastened on the vacuum door. Then the chariot allows the movement of all the components : resonator, door, amplifier, coupling system, and hydraulic circuit. The total weight is about 16 Tons. Fig.3.

On the strict RF point of view there is no very important tolerance except for the vertical dee position and for the parallelism of the fixed and movable "waved" panels. All the controls, on the first resonator, have shown that the tolerances are well below the permitted values.

2. RF Measurements.— The most important value to be measured is the maximum frequency which is completely determined by the mechanical dimensions and by the maximum capacitor spacing. As shown on the Fig.4, measurements follow exactly the calculations corrected with the 1/3 scale model results.

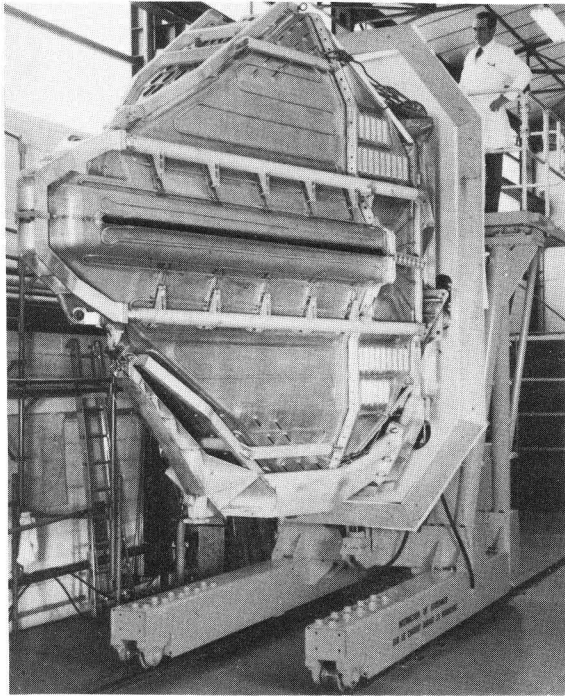

Fig. 3: SSC resonator assembled.

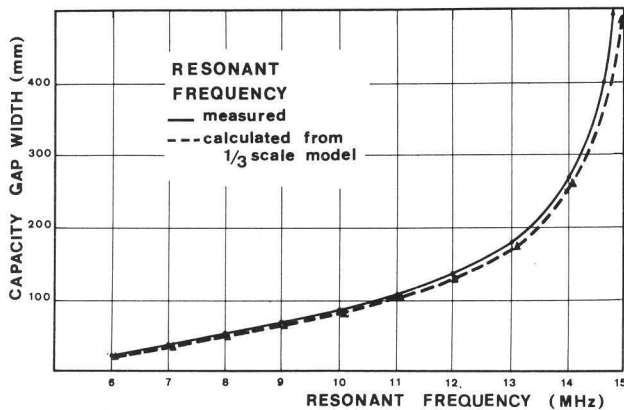

Fig. 4: Tuning curves.

For the Q_0 value at the maximum frequency the measured value is 15 % better than the calculated one (in which were included 15 % of "unknown" losses!). This indicates a good welding of all the copper pieces. Of course the maximum RF power needed to produce 250 kV will be also reduced at 14 MHz and be less than 80 kW. Fig.5 .

Due to the better value of Q_0 it is necessary to adjust the surface of the fixed coupling loop in order to be in the range of 20 to 110 Ω previously adopted for the "π" network circuit of the amplifier.

The resonator is now completely equipped in the dummy vessel which is pumped by a 20000 l/s cryogenic pump and by a 3500 l/s turbomolecular pump. A vacuum better than 2.10^{-7} Torr has been reached. (There is a small leak on an "out of tolerances" metallic seal). Initial experiments with the 100kW RF amplifier connected will start soon.

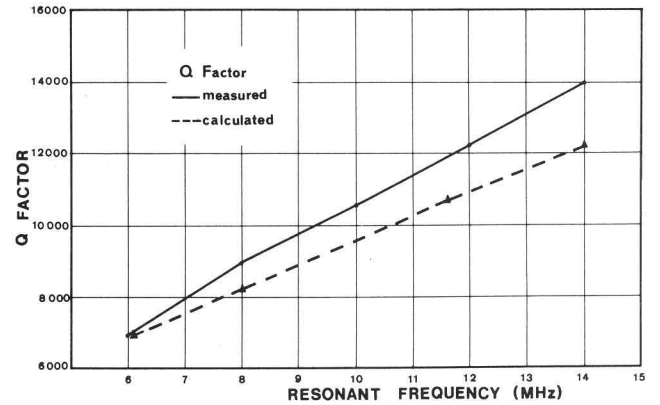

Fig. 5: Q_0 factor VS Resonant frequency.

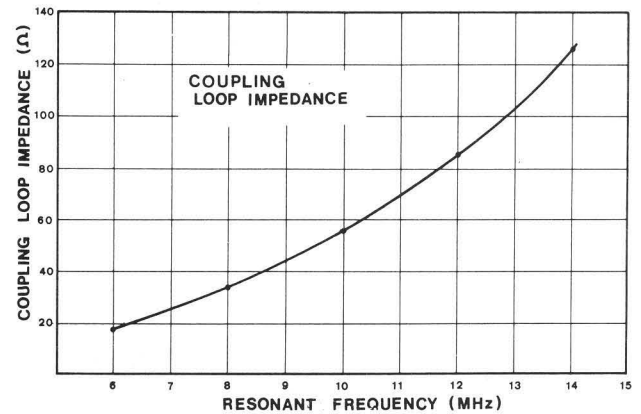

Fig. 6: Coupling loop impedance.

3. RF Transmitter.- As previously reported (2) a 100kW prototype has been successfully tested on a fictive load. Then, with some minor modifications a series of 6 amplifiers (the two injector cyclotrons use the same amplifier with a RF power limited at 60 kW by the power supply) has been constructed.

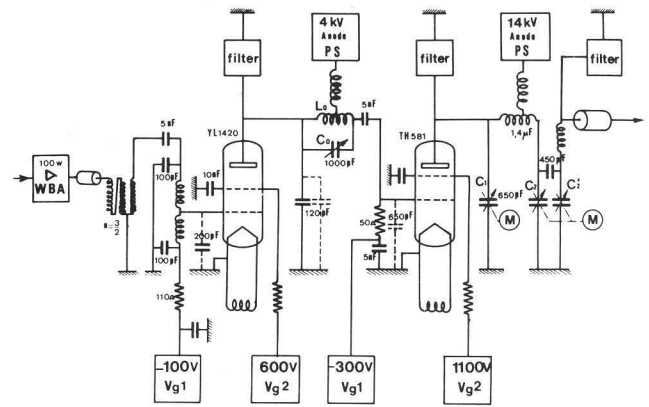

Fig. 7: Schematic diagram of the amplifier.

Some band pass filter have been placed in the plate circuit of each tube and in the output circuit to suppress the harmonic distortion created by parasitic resonances in the different connections. Depending on the feeder length (0.6 m in the injector transmitter and 2 m for the CSS resonator) it is necessary to add a small inductance in series with the feeder (L_s) if we want a symmetrical variation of the plate impedance. This is important for the resonator servo tuning system which uses the phase error signal between grid and plate RF voltage of the power amplifier (3). Fig. 7 shows a schematic diagram of the 100 kW amplifier.

Two stepping motors move the capacities C1 (Tuning) and C2 - C'2 (matching impedance). They are controlled by a local microprocessor. The positions of these elements are setted according to tables which have been determined by measurements of the TH581 plate impedance, feeder coupling loop and resonator being replaced by their equivalent impedance measured previously at cavity resonance. Then C1 and C2 - C'2 are adjusted to obtain the right plate impedance and a well centered circle in $R + jX$ terms. The 2 kW pre-amplifier is tuned by a variable capacity (in fact equivalent to a variable inductance) The tuning criterion is the maximum voltage on the 50Ω load of the power amplifier grid. For the maximum output power 70 W are necessary on the grid circuit of the pre-amplifier which are given by a 100W broadband amplifier.

Two amplifiers are now operational : one on Col and the second on the first CSS resonator.

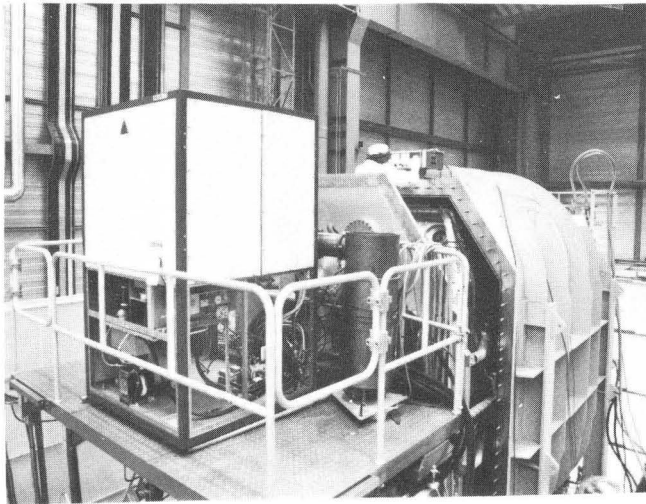

Fig. 8 : Power amplifier being tested on the resonator plate forme.

4. Sliding contacts development.-

Tests of various type of sliding contacts have been finished at the beginning of this year (4). Results are summarized in the curves of the Fig. 9.

5. Buncher.-

To produce the 130 kV peak on the electrode of the $\lambda/4$ structure of the buncher at 14MHz less than 20 kW are necessary. To simplify the tuning system the amplifier is shortly connected on the cavity and there is no matching plate circuit : the coupling loop gives directly the right plate impedance on the TH 571 A water cooled

tetrode. Fig. 10 shows a schematic diagram of the buncher amplifier. With the prototype connected to a fictive cavity (fixed inductance and vacuum capacitor) more than 20 kW (cw) has been reached at 14 MHz with 100W for the driving power and 200 W at 6 MHz for 15 kW (cw). A 300 W wide band amplifier drives the power stage. Complete test on the buncher cavity will start in october.

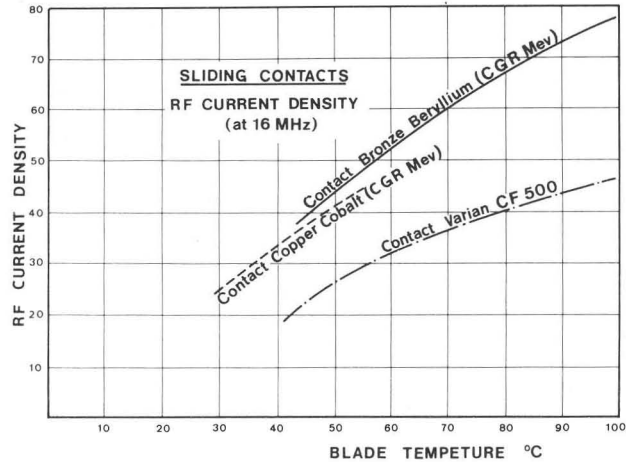

Fig. 9: Density current VS temperature.

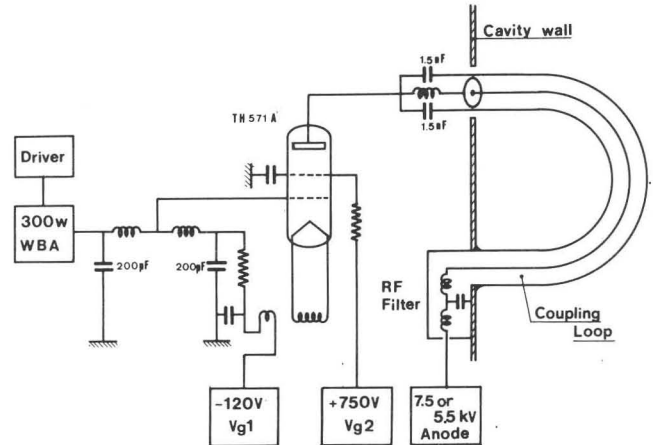

Fig.10: Schematic diagram of the Buncher amplifier.

References

1. BIETH C, DUCOURET B, JOUBERT A, PAGANI C, YIN Zu Kang Les Systèmes accélérateurs du GANIL fascicule II GANIL 80R/148/HF/23 oct.80.
2. C. BIETH, G. DUGAY, A. JOUBERT, C. PAGANI, J.M. BAZE GANIL RF Systems.
3. B. DUCOURET, A. JOUBERT, F. LABUSSIERE, GANIL RF Systems :Feedback Control Systems and Electronics. (This conference).
4. B. DUCOURET et al., GANIL 81N/069/HF/07 Results of Sliding Contacts test.