

THE MICROPROBE AT THE HAMBURG ISOCHRONOUS CYCLOTRON - USING HIGH ENERGY PROTON INDUCED X-RAY
FLUORESCENCE RADIATION

H. Brückmann, W. Vogel, H.-W. Boie, U. Schröder

Cyclotron Laboratory[†], I. Institut für Experimentalphysik, University of Hamburg, Luruper Chaussee 149,
D-2000 Hamburg 50, West Germany

Abstract. - A high quality cyclotron beam and the installation of a "microprobe" allow to apply ion beams of 10-30 MeV protons to analytical problems which require spacial resolution as well as quantitative determination of element distributions. The use of high energy protons offers significant advantages for practical applications. Unique features of the apparatus and the electronics offer a wide feasibility for on-line analysis and colour map-displays of the resulting element distributions. Examples show results for a specimen containing different alloys and specimens which were investigated in order to explore the dynamics of osteogenesis.

A high quality cyclotron beam and the installation of a "microprobe" make investigations feasible which aim at elements spacial distributions. High energy protons have not been used for such purposes up to now, but offer significant advantages with substantial consequences for the application as an analytical tool:

i) Below 10 MeV medium Z atoms exhibit a cross section for proton induced X-ray production which is steeply rising with energy (fig. 1)¹⁾. The stopping power dE/dx , however, is considerably declining (fig. 2)²⁾. If protons are moderated to an energy of less than 2 MeV they would dispose the rest of their energy in a very small layer of the specimen but hardly induce any X-ray emission. High energy protons dispose far less energy per micrometer by transversing a sample of about 100 μm thickness and are still high efficient in K-shell X-ray production. Normalized to the same production rate of X-rays the radiation dosis in the sample will be for 26 MeV protons 2-4 orders of magnitude smaller than for 2 MeV protons.

ii) With low energy beams surface effects of the specimen are dominating in the data achievable³⁾. Higher energies make the method feasible for measurements in layers of up to 200 μm or even more. Such protons will penetrate a long distance through the sample without remarkable straggling or energy loss. Radiation which is emitted deep below the surface by elements distinctly higher in Z than the matrix (e.g. an organic matrix with $\rho = 1 \text{ g/cm}^3$, 20% C and 80% O is assumed) still reveals a rather high X-ray transmission coefficient (50-100%, see fig. 3). Thus not only a very thin surface layer but an appropriate volume of the specimen can be quantitatively analyzed in its chemical compounds or the distribution of trace-elements.

iii) By evaluating the whole spectra the local density of the sample or the local thickness, respectively, can be measured simultaneously.

Fig. 4 shows the experimental setup at the Hamburg Isochronous Cyclotron. The main components of the instrument are an object diaphragm, two quadrupole magnets, a scan magnet and a vacuum chamber for the target samples.

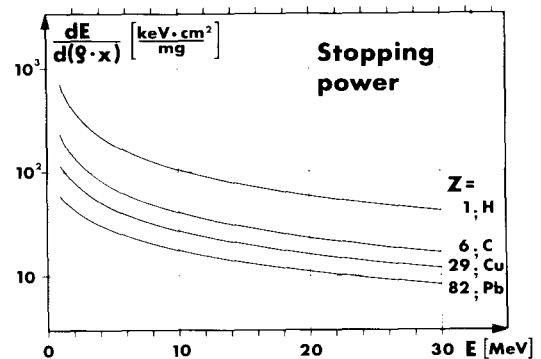
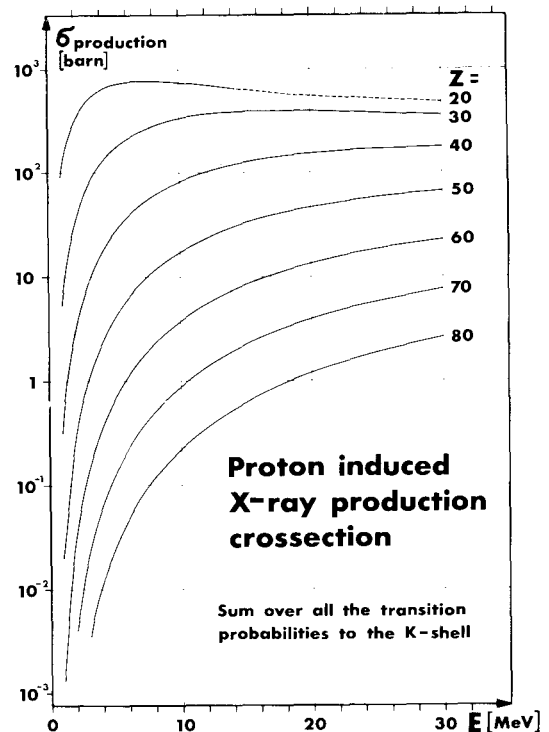

Fig. 1 and Fig. 2

[†] supported by BMFT (Bundesmin.f.Forschung u.Technologie)

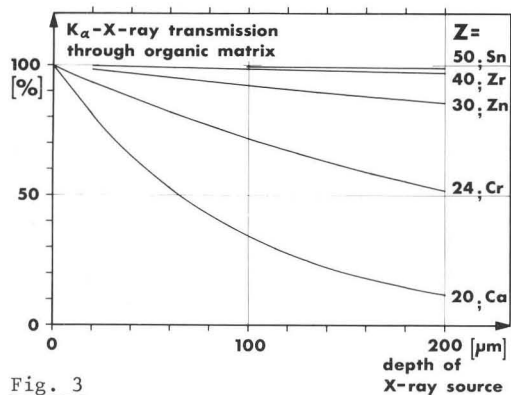

Fig. 3

Up to now no attempts at all have been made to minimize the diameter of our flying spot. Our distance quadrupole - target is still unconventionally large, hence for 26 MeV protons the flying spot has a diameter of 50 μ m. With a thick target (\sim 100 μ m) we easily achieve counting rates of a few 1000 cts/sec without special efforts. For most of the problems in technique, biology, medicine and environmental research beam diameters of 10-50 μ m are just adequate to the specimens. If the raster-scan data-aquisition allows an array of 256 \times 256 pixels, a 2 by 2 mm square is the appropriate spacial field of view.

Fig. 4 Experimental setup at the isochronous cyclotron, Hamburg

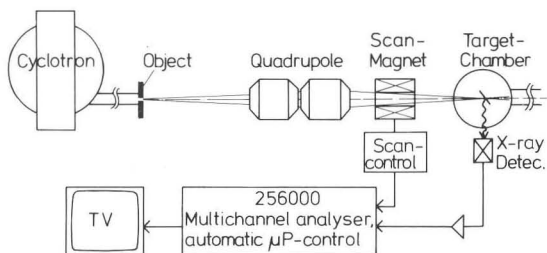

Fig. 5 shows the main components of the control- and data processing system schematically. The x-y raster-scan is obtained by magnetic fields which vary in a triangular shape with time. The two coils of the scan magnet are driven by a microprocessor programmed and controlled current supply. The X-rays emitted from the sample are detected by an intrinsic Germanium detector (with optical feedback preamplifier). The energy signal of the detector and the corresponding raster-scan coordinates are transferred to a high speed data-aquisition system. On-line processing of the data is carried out within the same system. The main components of the electronics are a 16 bit microprocessor and a stand-alone memory with 512 Kbyte capacity. Up to now the system is used as a multichannel analyzer with 256.000 channels delivering colour map-displays (intensity modulated 16 bit/pixel) of specimens investigated with the microprobe. A display of up to 16 spectra (e.g. profiles of the map-display) can be carried out simultaneously. The bit-assignment of the measured data to the pixel-intensity and RGB-colour can be altered by software at any time. Zoom and screen window facilities are hardware implemented.

A demonstration specimen "grid and wires" (fig. 6) was used for testing the focus of the ion-beam (spacial resolution), the energy resolution of the detector and background effect. The spectrum of fig. 7 is built up from all the events of the complete scan.

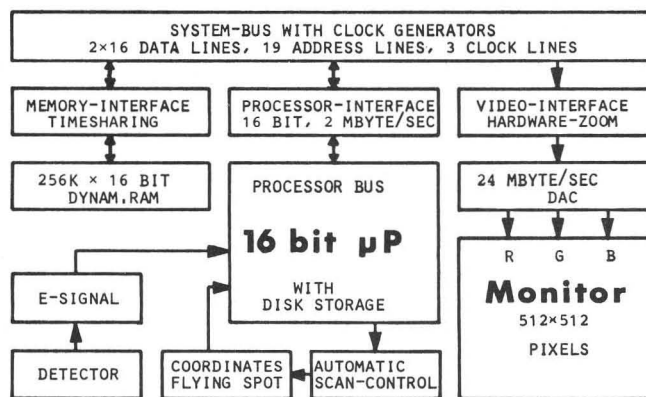

Fig. 5: Control- and data processing system

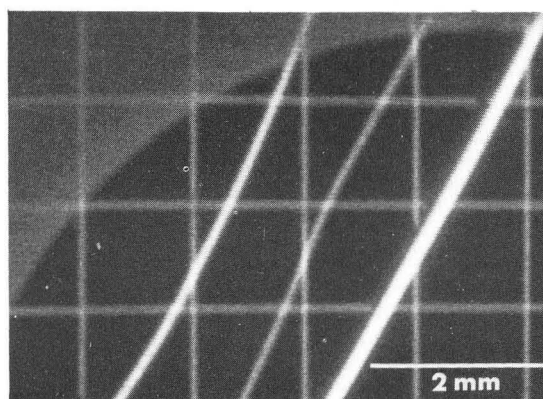

Fig. 6: Demonstration specimen "grid and wires": Consisting of a Ni-net (20 meshes per inch), wires with 13 μ m diameter) and 3 wires (Cu: ϕ = 30 μ m, Cumanin: ϕ = 20 μ m, Cu: ϕ = 100 μ m from l. to r.). The upper left side of the displays shows a part of the Aluminum target-frame (thickness 1 mm).

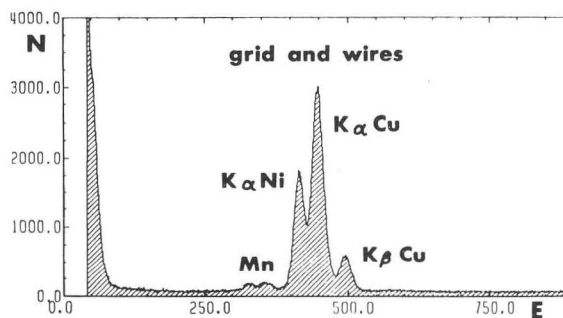

Fig. 7: X-ray spectrum corresponding to fig. 6.

In May 1981 the microprobe had seen beam for the first time. The first practical application of our microprobe dealt with the investigation of a ceramic implant in a bone of a rat to study the osteogenesis⁵⁾.

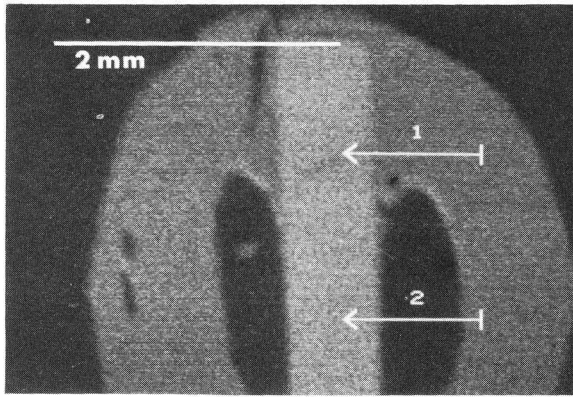

Fig. 8 illustrates a two-dimensional map-display of the bone cross-cut. In the centre a Strontium doped ceramic implant is to be seen. The two arrows indicate where the linear scan 1 and 2 have been positioned to measure the element distribution.

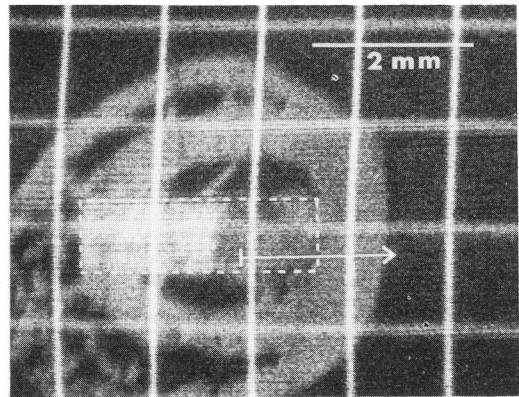

Fig. 11 shows the profile of a second specimen which contains Titanium doped ceramic material (dashed frame). The path of the scan is shown by the arrow. In order to illustrate the resolution and the metric scale of the linear scan, the sample has been covered by a reference grid (20 meshes per inch).

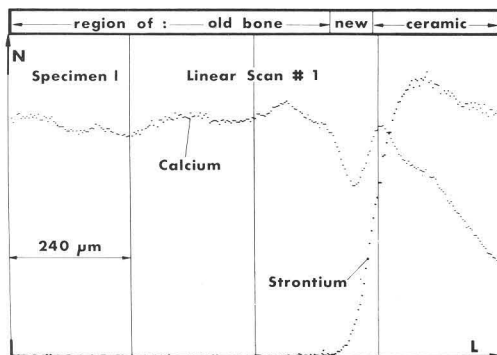

Fig. 9 shows the spacial distribution of Calcium and Strontium along the scan-path # 1. Assuming 10% Sr in the ceramic an average concentration of 350 ± 10 ppm Sr is present in bone. The spectrum has been built up from 10 Mio events which have been sampled during a 30 minutes exposure.

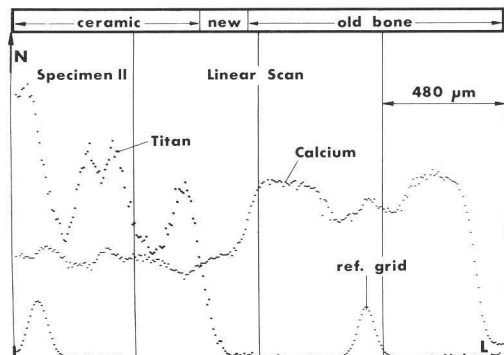

Fig. 12: Titanium and Calcium distributions are shown together with the scaling of the reference grid. No Titanium content is found in tissue and bone outside the ceramic. A 5 ppm Ti-content would have been noticed with significance.

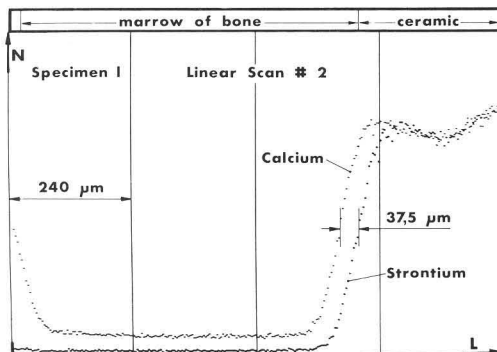

Fig. 10 shows the results obtained at the scan position # 2. To illustrate the Ca-Sr displacement at the interface zone of the ceramic material, the two spectra have been normalized to each other in the region inside the ceramic. The distance between Ca and Sr fall-off is $37.5 \mu\text{m}$.

We would like to acknowledge the assistance we have received from Mr. Ollhoff in the engineering of critical components of the apparatus. Furthermore many thanks are due to Mr. Grell and the other operators of the Hamburg Isochronous Cyclotron.

REFERENCES:

1. Calculated with the parameters of: S.A.E. JOHANSSON and T.B. JOHANSSON, Nucl. Instr. & Meth. 137(1976)473
2. C.F. WILLIAMSON, J.-P. BOUJOT, J. PICARD, Rapport CEA-R3042 (1966)
3. J.A. COOKSON, Nucl. Instr. & Meth. 165(1979)477
4. E.C. MONTENEGRO et al., Atomic Data and Nuclear Data Tables 22(1978)131
5. J.F. OSBORN, H. NEWSELY, C. WERHAHN, H. BRÜCKMANN, E. GABRIEL, Proc. of Second European Conference on Biomaterials, Gothenburg, Sweden (1981)