

BUNCHED BEAM STOCHASTIC COOLING FOR RHIC*

J.M. Brennan⁺, M.Blaskiewicz, F. Severino,

Brookhaven National Lab 11973, U.S.A.

Abstract

Stochastic cooling is an effective and well-established accelerator technology for improving beam quality. However, stochastic cooling of high frequency bunched beam has always proved problematic. We have built a stochastic cooling system for heavy ions in RHIC that is used on bunched beam. The purpose is to counteract Intra-Beam Scattering and improve integrated luminosity. The chief technical challenge of bunched beam is the strong coherent frequency components in the beam that contaminate the Schottky spectrum. Technical solutions for overcoming this problem are described. Results from commissioning in one ring of RHIC are reported.

INTRODUCTION

Stochastic cooling is an effective and well-established accelerator technology for improving beam quality. However, stochastic cooling of high frequency bunched beam has always proved problematic due to strong coherent components in the Schottky spectra of bunched beam.[1] We have built a stochastic cooling system for RHIC employing specialized techniques to overcome the problem of coherent components. The system works in the 5-8 GHz band and cooling in the longitudinal plane. The kicker of the system is realized in an unusual way by creating the kick voltage with 16 high-Q cavities. Even though the bandwidths of the cavities are much smaller than their separation in frequency the effective bandwidth of the cooling system is sufficiently covered. This follows from the fact the beam bunches are 5 ns long and the separation between cavity frequencies is 200 MHz, that is; the reciprocal of the bunch length.[2] The high-Q cavities greatly reduce the microwave power needed to operate the system. The system was first tested with protons during the FY06 polarized proton run. In the FY07 gold-on-gold run the cooling system was commissioned and proved effective in reducing the beam loss rate and debunching during 5 hour stores.

BUNCHED BEAM COOLING

Coasting beam formulae can be used to calculate cooling rate for bunched beam if the number of particles is replaced by an effective number which is the number that would be in the ring if it were filled at density equal to bunch density. For RHIC this is about $2e12$, and implies a cooling time of about one hour for a 5-8 GHz system. This is an adequate cooling rate to counteract Intra-Beam Scattering in RHIC. The key challenge of bunched beam cooling is to overcome the difficulties caused by the coherent components in the Schottky spectra. Figure 1 shows a spectrum with coherent

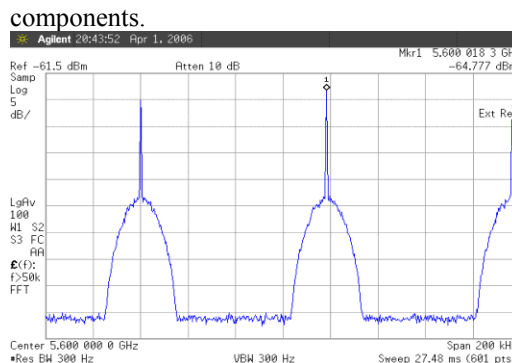

Figure 1 A Schottky spectrum showing coherent components.

Dealing with the Coherent Components

The true significance of the coherent components is not revealed in the frequency domain. However, their existence indicates that large instantaneous voltages are present in the time domain where they may easily overdrive active electronic components such as, low noise amplifiers, causing inter-modulation distortion which defeats the cooling loop. In order to reduce the peak voltages we employ the filter shown in figure 2, which is built from coaxial cables, cut in precise 5.000 ns intervals.

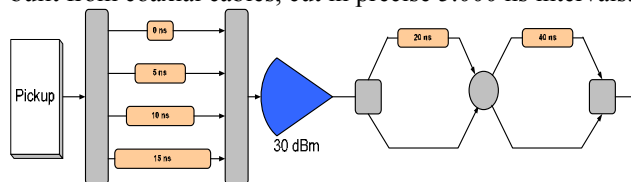

Figure 2 Coax filter used to reduce peak voltages from the pickup before the low noise amplifier and electrical to optical converter.

The filter repeats at reduced voltage the 5 ns beam pulse as shown in figure 3 and creates the frequency response shown in figure 4.

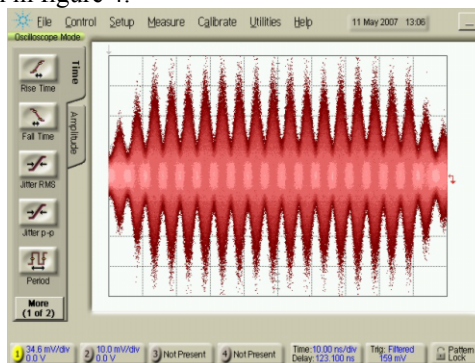

Figure 3, a time domain

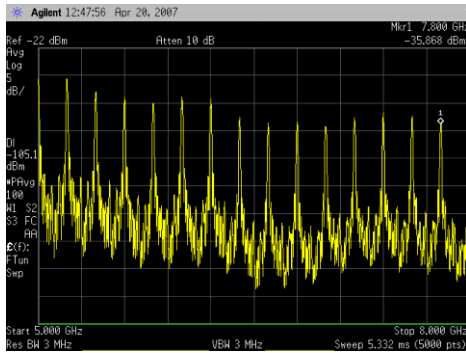

Figure 4 Frequency domain showing 16 lines between 5 to 8 GHz, spaced at 200 MHz.

The signal is sent from the pickup to the kicker via an AM modulated analogue fiber optic link of 6 microsecond length. We have found much better linearity in the link when the source DFB laser is modulated with an external electro-absorption modulator (PHOTONICSSystems, inc.) compared to direct modulation of the laser current. Direct modulation causes excessive chirp for large signal, which degrades the signal because of the dispersion in the fiber, SMF28.

The Cooling Filter

For momentum cooling a correlator notch filter is employed to create the correct phase of the kick so as to correct the measured energy fluctuations. The filter essentially differentiates the pickup signal to extract the sign of the energy error from the deviation of the beam signal from the synchronous revolution frequency. The concept is shown schematically in figure 5.

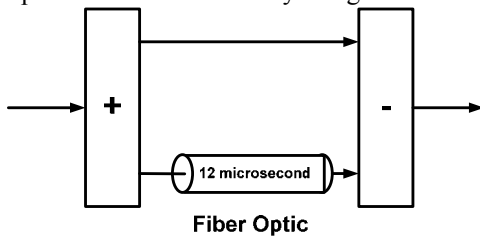

Figure 5. The concept of the notch cooling filter.

The notches it makes at revolution harmonics of the Schottky spectrum are seen in figure 6.

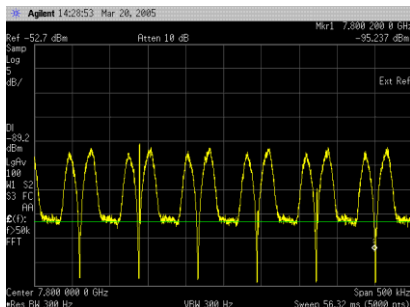

Figure 6. Notches made by the cooling filter.

From the system transfer function shown in figure 7 one sees that the real part (bottom display) changes sign at the revolution frequency (where the notch is). This causes the system to extract energy from the high energy particles and conversely.

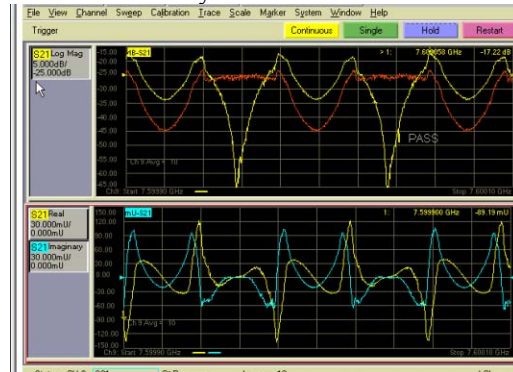

Figure 7. System open loop transfer function, including beam response. The real part is anti-symmetric about the revolution frequency.

Because the delay corresponding to one revolution period is 12.8 microseconds the filter must be realized with a fiber optic cable, in order to have constant frequency response across the 5 to 8 GHz band. The scheme for realizing the cooling filter is shown in figure 8. Matched pairs of photodiodes with >35 dB of CMR assure consistent notch depth across the band with no equalizer.

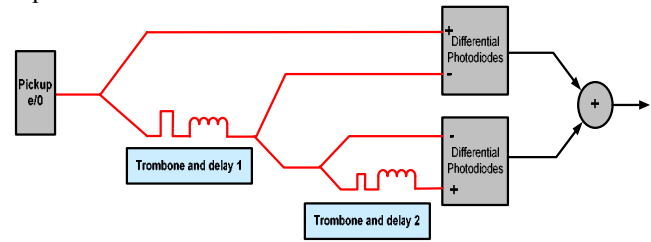

Figure 8 Realization of cooling filter. The four branches synthesize two filters in cascade.

Halo Cooling and the Two-turn Filter

The primary goal of the cooling system is to counteract IBS to prevent beam loss and debunching. This means that the most important particles to cool are those close to the separatrix. These particles have the greatest momentum offsets and are considered in the halo. A two-trun notch filter is used to concentrate the cooling power on the halo particles. The two-turn filter has a wider notch to exclude particles in core of the bunch and also to extend the momentum reach of the stable part of the cooling force. The cooling force from a one-trun filter (red) is compared to that from a two-turn filter in figure 9.

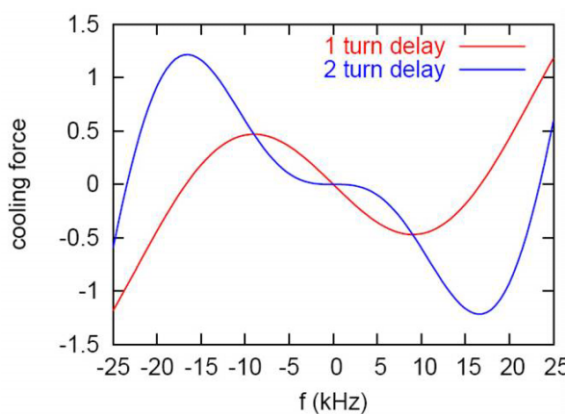

Figure 9 Cooling force for a one-turn(red) and two-turn filter

The two-turn filter is just two one-turn filters in cascade. One can see how the four branches of the filter in figure 8 constitute two filters cascaded filters by expanding the expression for the product of two one-turn filters.

$$S(\omega) = (1 - e^{i\omega T_{rev}})^2 = 1 - 2e^{i\omega T_{rev}} + e^{i\omega 2T_{rev}}$$

In figure 10 the response of the two-turn filter(red) is compared to that of the one-turn.

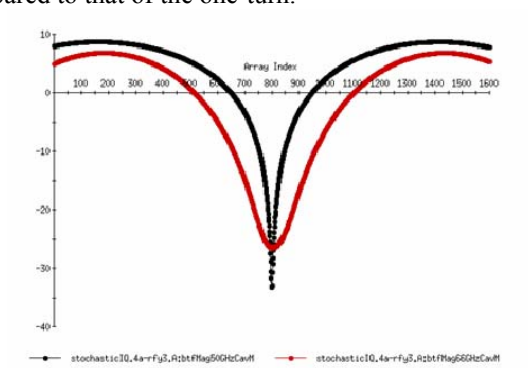

Figure 10 The response of the two-turn filter(red) compared to that of the one turn.

The Kicker Cavities

For optimal cooling of gold ions at 100 GeV/nucleon up to 250 keV must be supplied from the kicker each turn. Although the ion charge is 79 would require, nevertheless, 3 kV. One could consider a 50 Ohm kicker to cover the 3 GHz span of the system but the required power would then be 90 kW. We synthesize the kick with much less power by employing high-Q cavities to generate the kicks. The cavity frequencies are spaced at 200 MHz intervals in the 5 to 8 GHz band of the system. One can think of these frequencies as a Fourier synthesis of the kick, and because the bunch is 5 ns long the basic harmonic of the series is 200 MHz. The bandwidth of the cavities is chosen to allow filling and emptying the cavities between each bunch. This determines the Q of the

cavities and a high shunt impedance is achieved by using a four-cell TM₀₁₀ like structures with R/Q ~ 100 Ohm. A computer model of a typical cavity is shown in figure 11. They have equal two coaxial ports, one for incoupling and one for an external load (located outside the vacuum) which sets the desired loaded Q. They have a 20 mm beam bore hole, which is unacceptably small for the collider during filling and ramping. They are split on a vertical midplane and opened during filling and ramping and then closed for operation during the store.

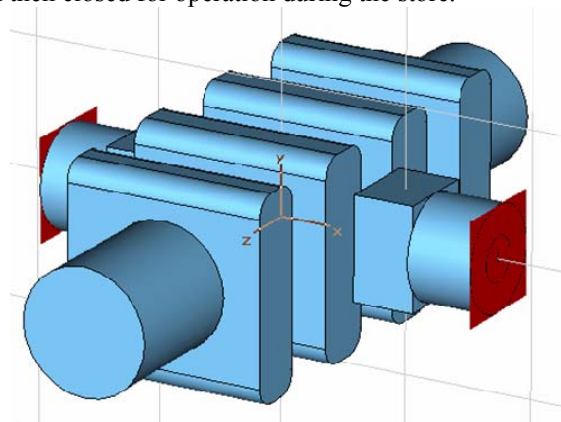

Figure 11 Computer model of a kicker cavity. It has a 20 mm bore and two matched coaxial coupling ports.

The Low-Level System

The low level system resembles a typical rf system with 16 cavities. Each cavity has an IQ modulator and rf power supply (40 Watts). The correct setting of IQs are obtained by measuring the system open loop response function including the beam(Beam Transfer Function). This is done automatically by the network analyzer. Software running in the embedded Window XP PC analyzes the BTF results and calculates settings for the IQs. This is done periodically (about every 15 minutes) during the store to adapt the system gain to cooling beam and to compensate drifts in phase. Phase drifts come about because of heating on the cavities and changes in the long fiber optic cables. The network analyzer also monitors the delays in the notch filters and sends commands to motorized optical trombones. Corrections are typically less than 1 ps in 15 minutes. The operation takes about one minute for a cavity and since the process takes one cavity out of 16 at a time off line, every 15 minutes, it amounts to a negligible degradation of the cooling. Figure 12 shows a typical system response function result.

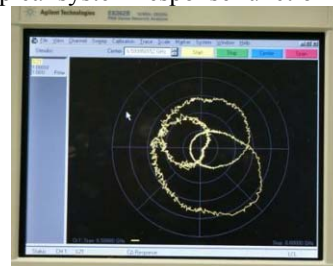

Figure 12 Cooling system response function including BTF and filters.

RESULTS

Tests with Protons

The first system tests were carried out with protons in the polarized proton run at RHIC of FY06. A special low intensity bunch was prepared as an analog to an ion bunch. This was the first successful test of bunched beam stochastic cooling and the results are published elsewhere.[3]

Operational Cooling of Gold Ions

The system was commissioned and made operational in the Yellow ring of RHIC in May FY07. Cooling showed the desired benefit of reducing losses and preventing debunching from the storage buckets. In fact, the losses in the Yellow ring when cooling became operational reached the level of “burn-off” losses. That is the situation when all the particles that are lost are consumed by collisions. Figure 13 shows the stored beam in RHIC for several stores of duration about 5 hours each. In the middle store stochastic cooling was used in the operation mode for the first time. It is clear that the loss rate in the Yellow ring was markedly reduced compared to previous stores and that of the Blue ring.

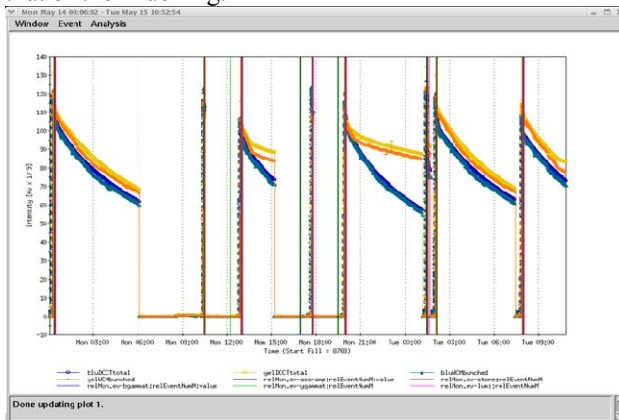

Figure 13 Five stores at RHIC, typically 5 hours. Stochastic cooling was operating for the middle two stores in the Yellow ring

It is apparent that the cooling not only stops losses but also cools the beam to a smaller emittance. In a preliminary test we cooled only half of the bunches in the ring by gating the system at the pickup. In this way we could compare the cooled and un-cooled under the same conditions. Figure 14 shows a scope trace of all the bunches after about 2 hours of cooling. It is clear that the cooled bunches attained higher peak current. Figure 15 compares a detailed view of the bunch profiles. Beam in the satellite 197 buckets is also cooled.

*Work performed under US DOE contract No DE-AC02-98CH1-886.
+ brennan@bnl.gov



Figure 14 Wall current monitor of all 100 bunches. The first 50 were cooled for two hours.

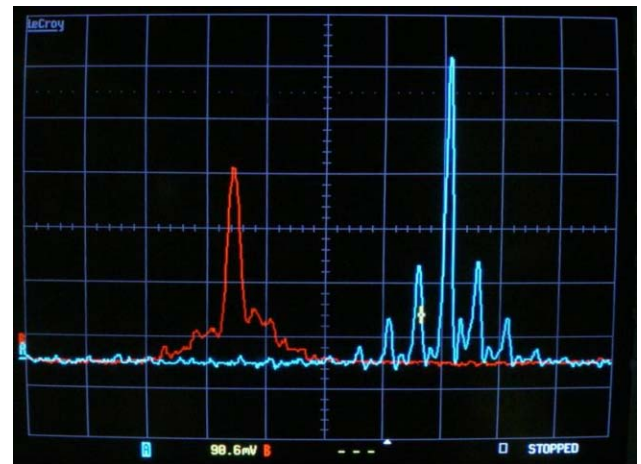

Figure 15 Expanded scale of bunch profiles comparing cooled (blue) and un-cooled bunches.

CONCLUSIONS

Bunched beam stochastic cooling at 100 GeV/nucleon has been achieved at RHIC. A cooling system is operational in the Yellow ring and cools Gold beam to reduce beam losses and reduce the longitudinal phase area of the bunches.

REFERENCES

1. G. Jackson et al, A Test of Bunched Beam Stochastic Cooling in the Tevatron Collider, PAC91, p1759
2. D. Boussard, Schottky Noise and Beam Transfer Function Diagnostics, The Queen's College, Oxford, England, 1985, CERN 87-03 Vol. II
3. M Blaskiewicz, J. M. Brennan and J. Wei, Stochastic Cooling in RHIC, II, EPAC06, Lucerne p2861