

## BUTTON BEAM POSITION MONITORS FOR FLASH

J. Lund-Nielsen\*, N. Baboi, DESY, Hamburg, Germany; W. Riesch, DESY, Zeuthen, Germany

### Abstract

FLASH accelerates electron bunches to up to 750 MeV for producing intense, coherent, very short pulses of radiation in special undulators. Various types of BPMs are installed in the linac: cavity and re-entrant-cavity BPMs in the accelerating cryo-modules and button and stripline BPMs in the room-temperature sections. The undulator section is one of the most critical areas of the linac in terms of beam position, therefore here the requirements on the BPMs are tightest. Due to the limited space, button BPMs were mounted here. The electronics is based on the AM/PM principle. In the past couple of years these BPMs were commissioned and intensively studied. A few modifications have been made in the electronics, in order to deal with the small signals and the very high frequencies of the ultra-short bunches. The studies and changes on the electronics are presented in this paper.

### INTRODUCTION

FLASH (Free Electron Laser in Hamburg) [1] is a user facility for an intense coherent ultra short radiation, as well as a test facility for the European XFEL (X-Ray Free Electron Laser) and the ILC (International Linear Collider). Electron bunches are compressed and accelerated to up to 750 MeV<sup>#</sup>, before passing about 30 m of undulators where the radiation is produced.

Since the intensity and stability of the radiation depends critically on the beam position, several tens of beam position monitors (BPM) of various kinds are installed in the linac. Cavity and re-entrant cavity monitors are mounted at the end of each of the 5 accelerator modules. Stripline BPMs are found in most of the room temperature sections. They provide large signals, allowing for a good resolution. In the undulator section, as well as in a few other locations, button monitors are installed due to space restrictions. The characterization studies made on the button BPMs in the diagnostics sections between individual undulators and some modifications that have been made on the electronics are presented in this paper.

### BUTTON BPMS

Four antennas mounted transversely and symmetrically in the beam pipe form a button BPM. There are two main types of button BPMs installed in FLASH. One has discs ("buttons") on the tip of the antennas and is used in areas with 34 mm cross-sections or larger. In the undulator section, the chamber has 9 mm diameter, so that solely thin antennas, 1.6 mm in diameter, are used (Fig. 1).

Inside the undulators similar antennas are mounted from the sides (up-left, up-right, down-left and down-right) and the signals from all four antennas have to be

combined in order to get the horizontal and vertical beam position. These BPMs are not discussed in this paper, but the electronics is the same as for the other button BPMs.

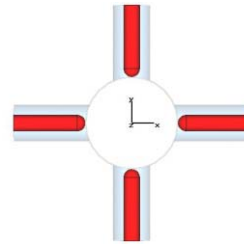

Figure 1: Button BPM in the undulator diagnostic station.

The undulator area is the most critical area from point of view of beam position and stability, therefore the monitors in this area have to be very precise.

### BPM Electronics

The electronics of the FLASH button BPMs works on the AM/PM (amplitude modulation / phase modulation) normalization principle [2]. Changes in the beam position determine a change – modulation – in the signals amplitude at the BPMs pickups. The electronics converts this amplitude modulation (AM) into a phase modulation (PM). The zero crossing of the two signals is compared and in this way the charge dependency is eliminated and the resulting pulse depends only on the beam position.

Fig. 2 shows the schematics of the electronic-boards in their present form. The signal from each pickup passes a pulse forming Gauss filter (cut-off 150 MHz) and then a 1 GHz low pass filter (SHF LP), which cuts the very high frequency components of the FLASH bunches. The signal is then pre-amplified by 40 dB by the dual low noise amplifier (LNA), which has a negligible drift between the two channels. The hybrid and the dual comparator transform the difference in amplitudes into a phase difference, which is then analyzed by the time comparator. The length of the resulting pulses is proportional to the beam offset. Four identical pulses are generated here, which are again LP filtered to obtain an averaging effect, before being amplified and DC-shifted by an operational amplifier. The peak of the pulse is then sampled using an external trigger, and then frozen for 1  $\mu$ s (the typical bunch spacing) by a Track&Hold amplifier. The delay of the external trigger as well as various internal parameters, such as the offset and hysteresis of the dual comparator, the offset of the operational amplifier, can be adjusted remotely by means of a I2C bus. This was important since many electronics boards are installed in the accelerator tunnel.

### MODIFICATION OF THE ELECTRONICS

After the initial commissioning of the undulator BPMs at FLASH, it was found that the position reading was very

\* jorgen.lund-nielsen@desy.de

# about 1 GeV will be reached after the shutdown in summer 2007.

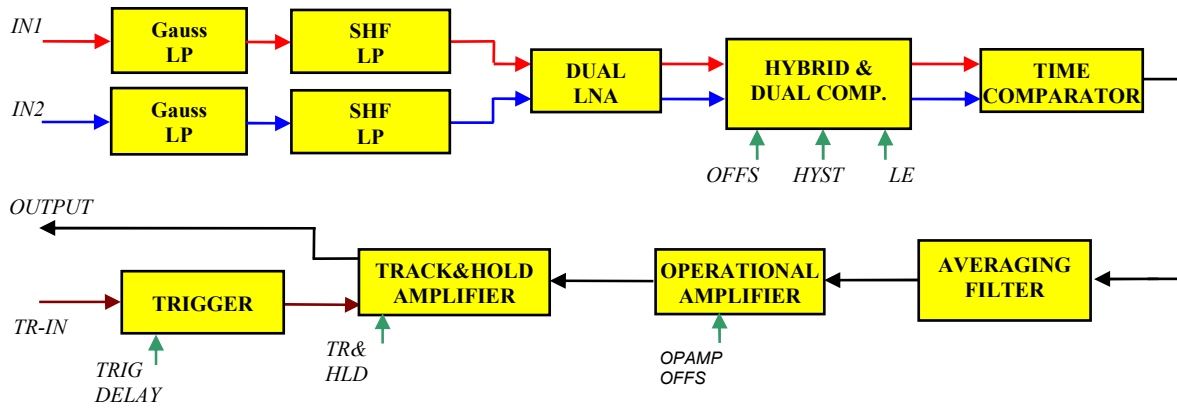

Figure 2: Principle of the FLASH button BPM electronics.

unstable, especially at low beam charge below 1 nC. Below 0.4 nC the electronics stopped responding. Also non-linearities were observed. These problems have been investigated and a few changes in the electronics proved to improve their performance.

**Signal Amplitude**

Investigations showed that the signal at the input of the AM/PM converter hybrid was too weak. On one hand the signal delivered by the pickups is much smaller than at TTF1, where similar BPMs were used, due to the lower charge. On the other hand, the upper cut-off frequency of the Gauss-LPF in conjunction with the lower cut-off frequency of the monitor, results in a very small signal amplitude. This is shown in Fig. 3. The dotted line represents the transfer function of the BPM pickup, normalized to 0 dB, as obtained from a simulation with Microwave Studio [3]. A wire has been used in the center of the beam pipe with a radius of 300 μm [4]. A measurement made on a similar BPM at TTF1, shows a resembling result [5]. The continuous curve in Fig. 3 is a measurement of the transfer function of a Gauss LP filter. At the frequency of the pickup signal, around 300 MHz, roughly 20 dB are lost in the filter. In order to compensate for this, an additional amplifier was installed.

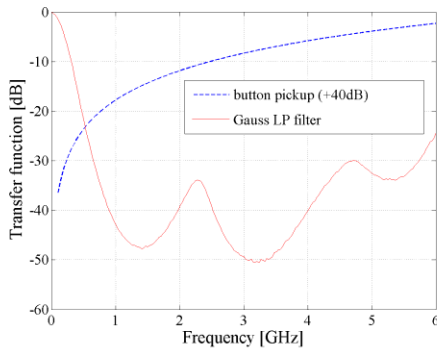

Figure 3: Transfer function of the BPM pickup (simulated) and of the Gauss LP filter (measured).

**Charge Dependent Non-Linearity**

The additional amplifier cured the susceptibility to the low bunch charge. However the reading was still somewhat unstable and showed some charge dependent non-linearity, which was not noticed on the bench. The electronic itself showed a certain non-linearity on the bench, but this was, repeatable from unit to unit and it was not bunch charge dependent. More on this topic is presented in the next sub-section.

We have found that strong very high frequency signals passed the Gaussian LPF. These frequencies are generated by the very short bunches. Fig. 4 shows the measured transfer function of a Gauss LPF up to 20 GHz. It can be seen that at about 8 to 10 GHz the signal is damped only by about 10 dB. These high frequencies were above the cut-off of the dual LNA and drove it into saturation. The amount of distorted - wanted signal - and the additional fraction of ultra high frequencies that pass the amplifier lead the fast comparators to misbehave, hence to unstable and non-linear response of the electronics.

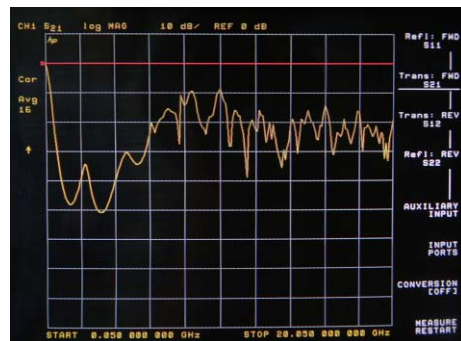

Figure 4: Measurement of the transfer function of the Gauss filter.

An additional LPF (SHF LP in Fig. 2), which has a specified 40 dB minimum attenuation from the cut-off at 1 GHz up to 20 GHz, cured the saturation effects and also the odd non-linearities. Fig. 5 shows a measurement of the Gauss LPF followed by a SHF LPF.

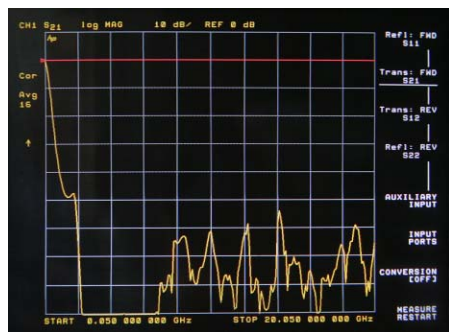

Figure 5: Measurement of the transfer function of the Gauss filter followed by a SHF LP filter.

Fig. 6 presents a measurement of the beam signal from a BPM pickup at FLASH after the Gauss filter. The bunch charge was about 1 nC. The distorted signal is cleaned by the addition of the SHF filter, as the measurement in Fig. 7 shows.

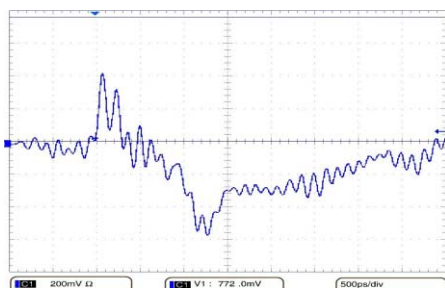

Figure 6: Measurement of the beam signal at FLASH after passing the Gauss LP filter and the (inverting) LNA.

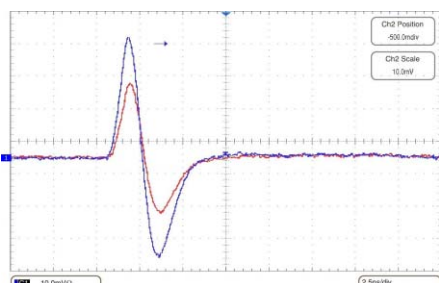

Figure 7: Measurement of the beam signal at FLASH after passing the Gauss and the SHF LP filters and the (inverting) LNA.

### Further Non-Linearity

One source of non-linearity of the electronics, proved to be a reflection at the LP-averaging filter, back to the prior electronic and then back to the filter again, all inside of the measurement time. This disturbs the pulse-width modulated signals, more or less dependent on the actual pulse width. The cure was a bit "brute force" by inserting a delay line, so that the reflections fall out of the measurement time slot. Other methods (additional back-termination and a matching network) are rejected due to the resulting loss in signal amplitude, which would require extra amplification again.

Another source of nonlinearity was found in the operational amplifier, which had slew rate limitations.

Here the cure was swapping some components and low pass filtering in front of the amplifier.

### Trigger Jitter

The remaining unstable reading of the electronic, which was not present at the bench, was investigated and some causes were found. The averaged signal of the PWM was frozen with a track-and-hold circuit due to the FWHM of the signal is about 3-4 ns long and has to be hold constant for the external, relatively slow ADC.

An external trigger is used. Unfortunately this trigger was found out to have too much jitter and was also drifting over time, so that the sampling point was uncertain, leading to an unstable measurement. Careful centering of the moment of freezing lowers the amount of noise. When the trigger is riding near the rising or falling edge, the BPM noise gets worse.

To cure the timing problem, an additional electronic is under investigation [6]. This electronic resynchronizes the timing with a very clean and stable 81 MHz signal, delivered from the master oscillator. Measurements with a prototype showed an improvement in the trigger jitter by up to a factor of ten. During the shutdown in summer 2007 all BPM crates will be equipped with this trigger conditioner. On the other hand a program has been written that automatically sets the trigger on the signal peak.

During the measurements of the resynchronization electronics, another jitter source was found: The trigger distribution boards, used in all crates, are inverting the trigger signal, which was not expected. So the electronics triggered on the wrong edge, which was found to be not as stable as the designated edge. A patch, correcting the distribution boards will be done during this shut down.

## SUMMARY AND CONCLUSIONS

Intensive studies with beam and on the test bench have lead to several changes in the electronics of the button BPMs at FLASH. The noise and the linearity have been improved. In this way the specifications of the BPMs have been largely met. The resolution determined with a correlation method [7] is around 10  $\mu\text{m}$  rms. Other characteristics of the BPMs are to be studied in the future, as for example the long-term drift.

## ACKNOWLEDGEMENTS

We thank our colleagues from MDI and other DESY groups for the contribution and the fruitful discussions.

## REFERENCES

- [1] V. Ayvazyan et al., Eur. Phys. J. D37, 297 (2006); W. Ackermann et al., Nat. Phot. 1, to be publ. (2007)
- [2] M. Wendt, DIPAC 2001, Grenoble, France.
- [3] <http://www.cst.com>
- [4] F. Marcellini et al., Nucl.Instr.Meth. A402 (1998) 27.
- [5] R. Lorenz et al., PAC97, Vancouver, B.C., Canada.
- [6] Axel Winter, Private Communication.
- [7] N. Baboi et al., BIW06, Batavia, IL, U.S.A.