

# EXCITATION STRIPLINE FOR SOLEIL FAST TRANSVERSE FEEDBACK

C. Mariette, J-C. Denard, R. Nagaoka  
 Synchrotron Soleil, Gif-sur-Yvette, France

## Abstract

SOLEIL, the new French third generation light source, is equipped with excitation striplines for a tune monitor and for the (bunch-by-bunch) Fast Transverse Feedback that has been recently implemented. A careful design of the striplines and their vacuum feedthroughs was aimed at maximizing the effectiveness of the excitation power via high shunt impedances, and minimizing the power taken from the beam via parasitic mode losses. Three stripline kickers have to be developed for these applications. We report on the design of the first two, using RADIA and GdfidL simulation codes.

## INTRODUCTION

The first transverse feedback implementation has been done with an existing stripline kicker initially meant for a spare tune monitor. The system includes a BPM, an RF Front-End, a processor, two power amplifiers and a stripline kicker. The tune stripline is not optimized for this application. The SMA feedthroughs cannot really feed a large amount of power to the stripline. Its length and the short circuited design will not be efficient enough to damp the beam instabilities next year when the second cryomodule will allow the beam current to raise from 300 to 500mA. But it is efficient up to 300mA.

The main instabilities being in the vertical plane, we only address that plane at the moment. This paper compares the simulations between the TFB and the tune striplines.

The magnetic field simulations have been done using Radia code. The signal reflection, shunt impedance and beam impedance have been calculated using the GdfidL code.

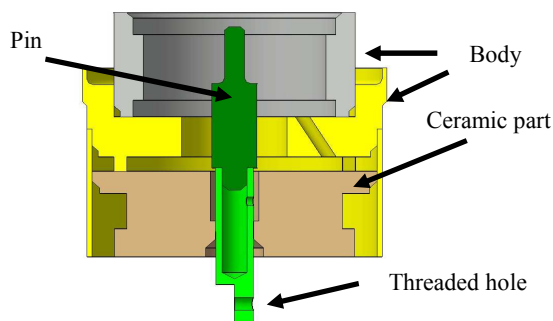

Figure 1: N-type feedthrough design

## TFB STRIPLINE SIMULATIONS

The vertical stripline is matched to a 50Ω characteristic impedance with feedthroughs at both ends. The 426mm long electrode corresponds to λ/2 of RF frequency (352MHz). The stripline transverse geometry is strongly constrained by its 50Ω characteristic impedance. The first

design guideline is to keep the electrode flush with the vacuum chamber wall, avoiding cross section changes from upstream and downstream.

## Feedthrough Design

A new N-type feedthrough has been developed in order to allow a greater excitation power. There is a threaded hole on the feedthrough for the connection to the electrode (fig. 1).

The feedthrough ceramic geometry has been optimized for minimizing the reflection in time domain (Fig.2).

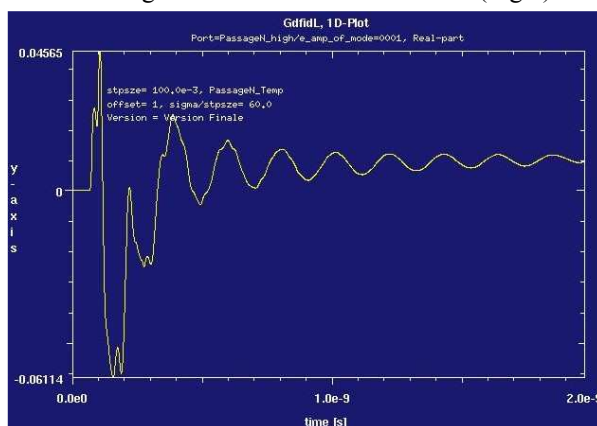

Figure 2 : N feedthrough reflection in time

The maximum reflection is about 5% during a very short time. The feedthrough is matched to 50Ω up to 10GHz.

## Stripline Design

The capacitive gap at the end of the electrodes is kept as small as possible in order to suppress the parasitic mode losses. The feedthroughs are connected to the electrodes by a 0.2mm thick stainless steel foil. Each electrode stands on three quartz columns. The figure 3 presents the stripline inner.

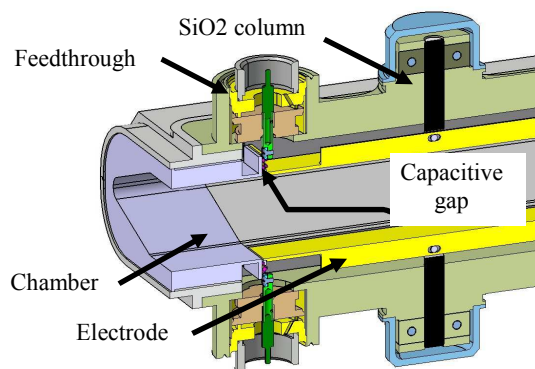

Figure 3 : TFB Stripline Geometry

### Stripline Electric Field Simulations

The electric field has been estimated in 2D static regime. The field in the vertical plane has a maximum value of 6.9kV/m, with a driving power of 2 x 75W rms.

The figure 4 presents the electric field distribution of a quarter stripline transverse plane.

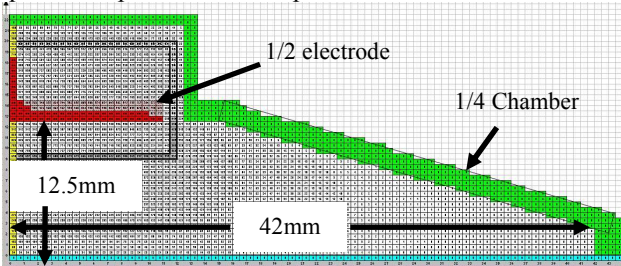

Figure 4: Electric field distribution in 1/4 of the stripline cross-section.

The electric field is computed with Microsoft Excel in one quarter of the vacuum chamber cross section, as shown in figure 4.

### Stripline Magnetic Field Simulations.

The magnetic simulation corresponds to a current of 1.41A, from 50W amplifiers. The magnetic field on the beam path is shown in figure 5. The field stays above 35μT in ±5 mm from the orbit center.

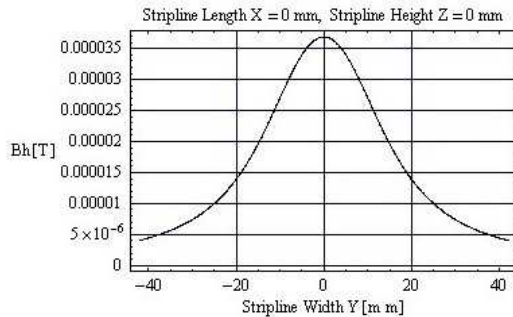

Figure 5: Magnetic field on the horizontal plane

Two 75W RF amplifiers will create a 45μT magnetic field on the beam path.

### Stripline Time Domain Analysis

The S11 reflection parameter on the feedthrough is shown in figure 6 [1].

The -0.7 reflection peak corresponds to a capacitive gap added at each electrode end for reducing the parasitic mode losses. The capacity is made of two lips facing each other, one on the electrode, the other on the vacuum chamber wall (Fig.3). In this way, only the lower part of the beam spectrum power is trapped into the stripline structure. There is a reflection before this peak. It is due to the feedthrough-to-electrode connection.

After the peak, the plot corresponds to the electrode 50Ω impedance of the stripline.

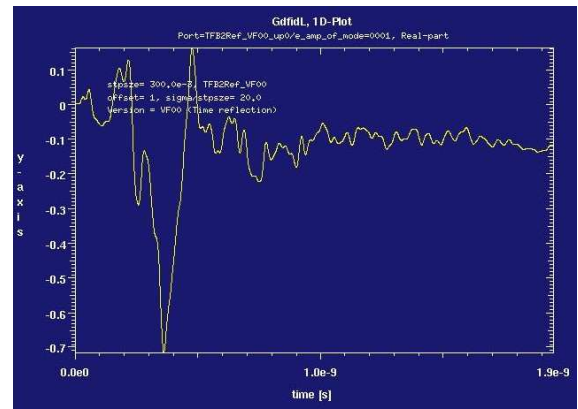

Figure 6: S11 parameter simulation with Gdfidl

### Stripline Coupling Impedance

The longitudinal and vertical beam impedance, respectively ZL and ZV, versus frequency are shown in figures 7 and 8. They are small.

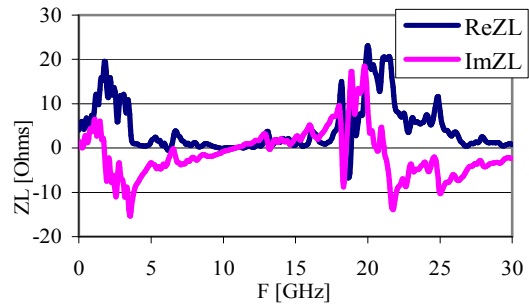

Figure 7: Calculated longitudinal impedance

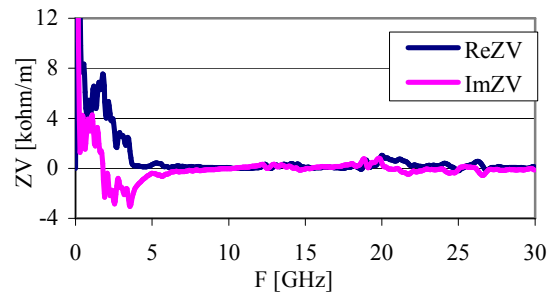

Figure 8: Calculated vertical impedance

The remainder is due to the beam proximity (12.5mm) and to the non negligible gap size. At the beginning of the study, the gap was 0.3mm wide. But, one expect significant lengthening expected during the baking to 180°C. The gap has been widened to 0.5 mm to avoid the risk of short circuit. Having the capacitive gaps at the end of the electrodes decreases the parasitic mode losses by a factor of two.

### Stripline Shunt Impedance

The shunt impedance (Zsh) is representative of the stripline efficiency: the higher the better. Zsh has been estimated versus frequency.

The 2D (Poisson's law [3]) and 3D (Gdfidl [2]) simulations are shown in figure 9.

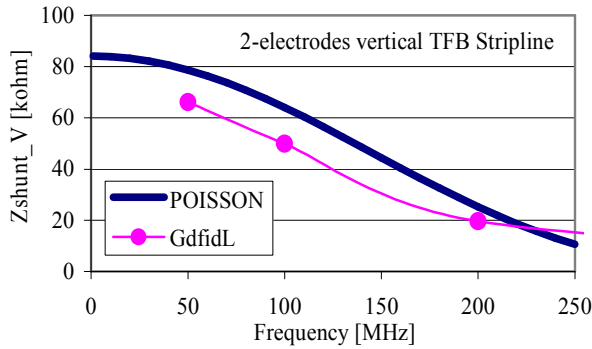

Figure 9: Calculated shunt impedance versus frequency

Both results predict a high shunt impedance value.

### SIMULATION COMPARISON

The TFB stripline simulations are compared to that of the tune stripline.

#### Efficiency Difference

The Excel simulation indicates the new vertical stripline design will produce an electric field 6 times greater than that of the tune stripline, meaning a much higher shunt impedance. This is confirmed by Gdfidl. At 50MHz the TFB stripline shunt impedance is 66.2kΩ while that of the tune stripline is 590Ω. The longitudinal and vertical beam impedances of the TFB stripline and other Soleil equipments are shown in table 1 and 2. Compared to other Soleil equipments like the BPMs or the vertical scraper, the TFB stripline contribution to the vacuum chamber impedance is small.

Table 1: Longitudinal impedance comparison

|                | Loss<br>V/pC | Re(ZL) <sub>eff</sub><br>Ω | Im(ZL/n) <sub>eff</sub><br>mΩ |
|----------------|--------------|----------------------------|-------------------------------|
| TFB stripline  | 0.075        | 5.30                       | 1.62                          |
| Tune stripline | 0.007        | 0.48                       | 0.27                          |
| 120 BPMs       | 0.360        | 28.80                      | 13.2                          |
| V scraper      | 0.453        | 32.13                      | 7.03                          |

Table 2: Vertical impedance comparison

|                | Re(ZV) <sub>eff</sub> at ξ = 0.3<br>kΩ/m | Im(ZV) <sub>eff</sub><br>kΩ/m |
|----------------|--|-------------------------------|
| TFB stripline  | 0.46                                     | 0.88                          |
| Tune stripline | 0.02                                     | 0.03                          |
| 120 BPMs       | 2.4                                      | 4.8                           |
| V scraper      | 2.8                                      | 4.88                          |

The main differences between TFB and tune striplines are due to the transverse geometry. In fact, the TFB stripline has its electrodes very close to the beam. It also has feedthroughs at both ends. The tune stripline has four electrodes at a further distance from the beam (two upper electrodes and two lower electrodes) and they are shorted.

### CONCLUSION

We reported on the design of the vertical stripline of the bunch-by-bunch transverse feedback. The challenge is mainly to produce strong kicks with low parasitic mode losses. The tune excitation stripline served as a starting point. The deflecting force has been increased via the shunt impedance. The latter has been evaluated in time domain using Gdfidl in a 3D study [3], as well as with a semi-analytical method in frequency domain [2]. Both approaches gave consistent results. Unlike the tune excitation stripline, a 2-electrode structure was adopted for a higher efficiency, despite losing the advantage of working in both transverse planes. The optimised solution in this configuration yields a 66 kΩ shunt impedance at 50 MHz, which is nearly two orders of magnitude larger than that of the tune stripline. It allowed relaxing the output power requirement of the RF amplifiers. However, compared to the tune stripline, its impedance seen by the beam is 10 times greater; this is not a real problem since it remains small compared to other vacuum component of the machine such as the BPMs and the vertical scraper.

### ACKNOWLEDGEMENT

The authors thank J-L. Marlats and D. Zerbib of the SOLEIL Designing and Engineering Service, as well as our diagnostics colleagues.

### REFERENCES

- [1] W. Bruns, "The Gdfidl Electromagnetic Field Simulator", <http://www.gdfidl.de>.
- [2] D.A. Goldberg and G.R. Lambertson, "Dynamic Devices: A Primer on Pickup and Kickers", Lawrence Berkeley Lab., California, Nov. 2001.
- [3] A. Gallo, A. Ghigo, F. Marcellini, M. Serio, B. Spataro and M. Zobov "The Transverse Feedback Kicker", DAFNE, INFN, Italy, Dec. 1995.
- [4] R. Nagaoka, L. Cassinari, J-C. Denard, J-M. Filhol, N. Hubert, M-P. Level, P. Marchand, C. Mariette, F. Ribeiro, R. Sreedharan (SOLEIL, Gif-sur-Yvette), T. Nakamura, K. Kobayashi (JASRI/SPring-8, Hyogo-ken), "Transverse Feedback Development at SOLEIL", DIPAC 07