

STATUS OF THE 100 MEV PREINJECTOR FOR THE ALBA SYNCHROTRON

M. Pont, D. Einfeld, A. Falone, CELLS, P.O. Box 68, 08193 Bellaterra, Spain
 A. Setty, D. Jousse, J-L. Pastre, F. Rodriguez, THALES, 92 704 Colombes, France
 A. Sacharidis, EuroMeV, Buc, France

Abstract

The ALBA pre-injector is a 100MeV Linac provided by THALES Communications as a turn key system. The mechanical installation started in February 2008 and finished in April 2008. Also the installation of the first part of the Linac to Booster Transfer Line and the Linac Diagnostic Line was done simultaneously. The status of the ALBA Linac and Transfer line, the characterization of the Sub-harmonic pre-buncher and the description of the timing system are reported.

LINAC SETUP

The ALBA Linac consists of a 90 kV DC thermoionic gun, followed by a bunching system designed to reduce the energy spread and the electron losses. This one comprises a Sub-harmonic pre-buncher (500 MHz), a pre-buncher (3 GHz) and 22-cells SW Buncher (3 GHz). Two travelling wave constant gradient accelerating sections increase the energy up to 100 MeV. Beam focusing is ensured by shielded solenoids up to the bunching system exit and a triplet of quadrupoles between the two accelerating structures [1].

The Linac will work in single bunch and multi bunch mode, top-up operation is foreseen from the beginning. In table 1 the nominal beam parameters at the Linac exit are summarized.

Table 1: Nominal Parameters at the Linac Exit

| Parameter | Single Bunch | Multi Bunch |
|---------------------------|-----------------------|-----------------------|
| Pulse length | 1 ns | 40 to 1000 ns |
| Charge | ≤ 2 nC | ≤ 4 nC |
| Norm.emitt. (1σ) | $\leq 30 \pi$ mm mrad | $\leq 30 \pi$ mm mrad |
| Energy Spread | ≤ 0.5 % (rms) | ≤ 0.5 % (rms) |
| Energy | ≥ 100 MeV | ≥ 100 MeV |



Figure 1: ALBA Linac.

TRANSFER LINE AND LINAC DIAGNOSTIC LINE SETUP

The first part of the transfer line consists of a straight line with 3 quadrupoles and a bending magnet. Two lines come out from the dipole: the Linac to Booster Transfer Line and a so called Linac Diagnostic branch, where diagnostic equipment allows the characterization of the beam at the Linac exit. A list of the diagnostic equipment is given in table 2. Figure 2 shows a layout of the first part of the transfer line and the Linac diagnostic line.

Table 2: Diagnostic Equipment Installed in the Transfer Line and in the Diagnostic Line

| Item | Number | Purpose |
|--------|--------|---------------|
| FS/OTR | 2 | Beam profile |
| FCT | 1 | Beam current |
| BPM | 1 | Beam position |
| BCM | 1 | Beam charge |
| FCup | 1 | Beam current |

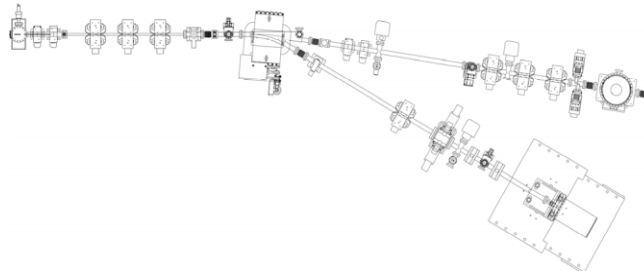

Figure 2: Layout of the transfer line and diagnostic line.

The Faraday Cup at the end of the Linac Diagnostic branch acts also as beam stopper, in addition two horizontal slits allow the characterization of the beam energy spread. Emittance measurement will be performed in the straight line downstream the Linac exit, by means of the triplet of quadrupoles and the FS/OTR monitor using the so called quadrupole scan technique.

A Graphical User Interface has been written in Pytango in order to control all the equipment involved in the measurement and to allow post-process of the data. Energy and energy spread measurements will be done in the Linac Diagnostic line where an additional quadrupole ensures that the beam is kept reasonably small.

PREBUNCHER CHARACTERIZATION

The Sub-harmonic pre-bunching cavity was characterized at EuroMeV using the beam coming out

from the electron gun. It is a pill box cavity derived from the ELETTRA pre-injector, working at 499.654 MHz.

The cavity is cylindrical, with a diameter of 460 mm and a length of 140 mm.

The theoretical quality factor, calculated with SUPERFISH is 22100. The measured one was found equal to 16120. One must consider that the theoretical values given for the quality factor must be reduced by at least 20%. In our case, we found a 27% reduction.

Figure 3 shows the output measured power versus the input frequency at 740 Watts.

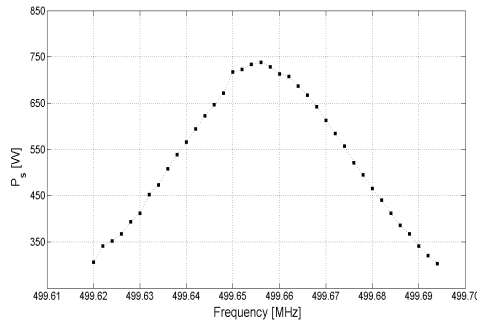

Figure 3: Output measured power vs. input frequency at 740W.

The beam dynamics simulations gave a beam modulation of about ± 25 kV. In order to characterize the cavity by finding the beam modulation versus the input power, the gun voltage was reduced in order to try to stop the beam pulse. To perform such a measurement, a very short pulse (100-150 ps) is needed otherwise it would not be possible to evaluate the modulation as the field in the cavity is changing (transit time factor).

Then the cavity was used in a de-bunching process in order to measure the flight time between a first FCT situated at 240 mm before the cavity and a Faraday cup at 330 mm upstream.

The flight time without RF power for different gun voltage was measured. Figure 4 shows the calculated and the measured flight time versus the gun voltage.

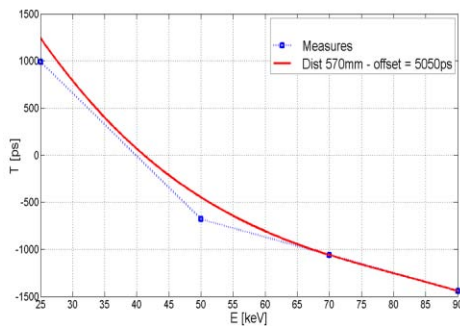

Figure 4: Flight time for different gun voltage without RF.

Measurements with an input power of 740 Watts were performed. For every gun voltage, the phase was adjusted in order to have the shortest flight time (de-bunching process). We are then sure that the beginning of the beam pulse has the maximum energy gain during the cavity crossing. Figure 5 shows the calculated and the measured

flight time versus the gun voltage for an input power of 740 Watts that produces a modulation of 35 kV.

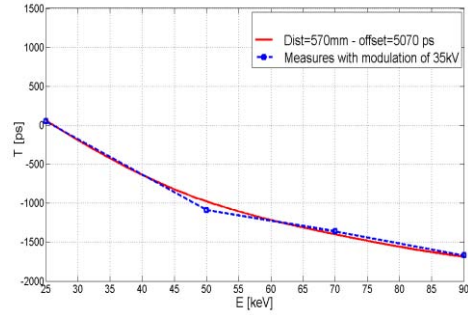

Figure 5: Calculated and measured time flight vs. Gun voltage with RF at 740W.

TIMING SYSTEM AND ELECTRON GUN MODULATOR

The Timing System of the ALBA Linac must deliver the trigger and gating signals to the electron gun, klystrons modulators, and RF pre-amplifiers. In the single bunch operation mode, the Linac will deliver a number of micro-bunches with a programmable time interval between them. The resolution of this time interval must be equal to the period of the Storage Ring, approximately 2 ns. Furthermore, it is necessary to precisely adjust the delay between the two RF signals of the accelerating structures in order to optimize the beam loading compensation.

Therefore a specific Timer Board based on fast ECL counters clocked by the master oscillator signal at 499.654 MHz was designed. The Trigger signal received from CELLS starts a set of counters that deliver:

- Two gating signals for the klystron RF pre-amplifiers,
- Two trigger signals for the klystrons modulators,
- The modulation signal for the electron gun.

Width and/or delay of these signals are remotely programmable with the suitable time resolution. The modulation signal for the electron gun is not a simple trigger signal, but a set of 1 ns wide pulses depending on the operation mode as represented hereafter:

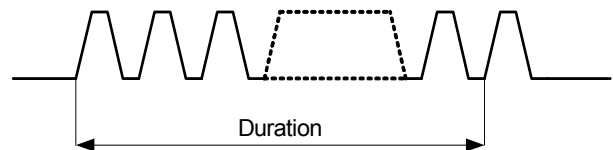

Figure 6: Multi bunch operation mode.

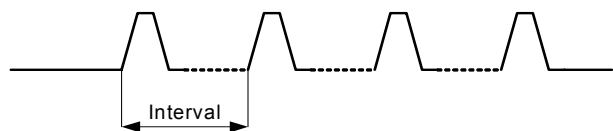

Figure 7: Single bunch operation mode.

In the multi-bunch operation mode, the total duration of the bunch is programmable from 40 to 1000 ns by steps of 8 ns. In the single bunch mode, the number of micro-bunches is programmable between 1 and 16 and the time interval is programmable from 6 to 256 ns by steps of 2 ns. This modulation signal is sent through a high bandwidth analogue optical link toward the electron gun modulator. There the optical receiver REC sends the modulation signal to a fast VMOS amplifier AMP that drives the cathode of an EIMAC Y845 assembly, according the following design. The cathode is polarized by the power supply PS1 and the filament is powered by PS2.

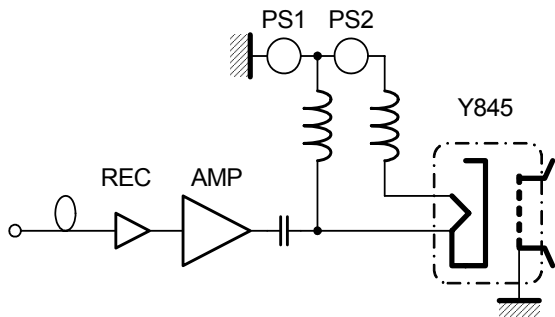

Figure 8: Polarization scheme of the Cathode EIMAC-Y845.

This design is more efficient and reliable than the classical solution using a RF generator for the multi-bunch mode and a pulse generator for the single bunch mode. The following figures show the beam current measured at the gun exit through Fast Current Transformers from Bergoz.

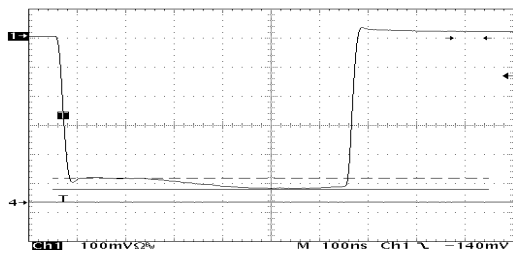

Figure 9: Envelope 600ns Multi Bunch mode.

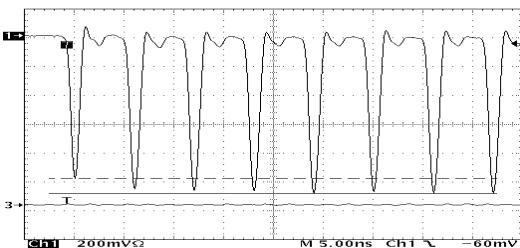

Figure 10: Single Bunch mode (8x6ns interval).

INSTALLATION

The Linac girders have been pre-assembled at THALES and shipped to CELLS in February 2008.

After that the mechanical installation and the cabling started. This task took 2 months. During the same period the first part of the Linac to Booster transfer line and the Linac Diagnostic line has been pre-assembled in house and installed by CELLS in the Linac bunker. Also services (water cooling, air compressed, electrical power, PSS) have been provided and successfully tested. Alignment of the Linac and Linac to Booster Transfer Line has been done by CELLS team. The transfer line and the diagnostic line are now fully equipped and cabled, the subsystems are tested.

COMMISSIONING PLAN

The conditioning of the two accelerating sections and the Buncher is now in progress. Both klystrons (TH2100, 35MW maximum peak power) are running at 1 Hz and the power delivered to the RF structures is gradually increased. The nominal values that have to be reached are summarized in table 3.

Table 3: Power delivered to the RF structures

| | Power | Buncher | AS1 | AS2 |
|-------|---------|---------|---------|--------|
| KLY 1 | 30.6 MW | 6 MW | 18.7 MW | - |
| KLY 2 | 24.5 MW | - | - | 20.5MW |

With this configuration 125 MeV at the Linac exit will be obtained. The 500 MHz Sub-harmonic pre-buncher has been already conditioned. After the conditioning of the RF structures, the commissioning of the Linac and the beam tuning will start.

First the multi bunch mode at low current and low energy (65 MeV) will be tested. Then tests at nominal current and nominal energy will be performed. In addition beam loading compensation will be implemented.

Finally the single bunch mode will be tuned. The site acceptance test is expected to be done in July 2008.

CONCLUSION

The 100MeV Linac pre injector for the ALBA synchrotron light source and the first part of the Linac to Booster Transfer Line has been successfully installed. The subsystems have been tested. The conditioning of the RF structures is now in progress.

The commissioning will start in the following weeks and the expected duration is about one month. The software for the measurements of the main parameters at the Linac exit (emittance, energy, energy spread) have been developed in Pytango and are ready to use.

REFERENCE

[1] A. Setty, "Beam dynamics of the 100 MeV preinjector for the Spanish synchrotron ALBA", PAC07, Albuquerque, USA, June 2007.