

# RAMPING POWER SUPPLIES FOR THE SSRF BOOSTER

R. Li, D.M. Li, H.G. Chen, T.J. Shen, S.L. Lu, D.X. Wang

Shanghai Institute of Applied Physics, P.O.Box 800-204, Shanghai 201800, P.R. China.

## Abstract

Shanghai Synchrotron Radiation Facility (SSRF) booster magnetic field ramped with a 250ms ramp, 2Hz repetition rate, and biased quasi-sinusoidal wave shape is successfully realized. Two Digital Switch-mode Power Supplies (DSPS) separately deliver currents to all dipoles, and other four DSPS deliver to the quadrupoles and sextupoles in families. Tracking precision and reducing line power fluctuation requirements are particularly challenging because of the fast ramp and high load inductance. In order to meet the requirements, the magnetic energy recycle, digital regulation and novel PID correction circuit are used. On Oct. 5th 2007, after a few days commissioning of the SSRF booster, the beam was boosted up to 3.5GeV firstly in SSRF, it proved that the design of ramping power supplies was correct and the manufacture was successful. The power supply system and its performance are described in this paper.

## INTRODUCTION

SSRF is a third generation accelerator which booster raises the energy of a 150MeV beam up to 3.5GeV in approximately 250msec. The booster is designed to work at 2Hz repetition rate and biased quasi-sinusoidal wave shape.

The dynamic magnetic field of booster must have a good consistency, so that the 6 power supplies should be stable enough and the control error less than 0.1%. SCR technology is one of the first topology used for booster power supplies, but which has a low power factor and have a big influence over line power. In the other way, switch mode power supply has character of high efficiency, high power factor and fast response. So, digital controller and switch mode power supply were selected for SSRF booster.

## SSRF BOOSTER POWER SUPPLIES SYSTEM DESCRIPTION

There are five types of ramp power supplies in SSRF booster, shown as in Table 1. Figure 1 shows the theory operating curve of dipole power supply. And the other four keep the track of dipole current by control error less than 0.1%.

The booster consist of 48 dipoles, 28 QF, 28 QD, 24 SF, 22 SD, 56 correctors. The two coils of each dipole are separate and alternately connected in series with each others and droved by two power supplies, Figure 2. The current direction is reverse to avoid globe magnetic field. The others are connected in series and powered by each power supply independently, Figure 3. The current

density of connection cable is about 1A/mm<sup>2</sup> (RMS value). The correctors are powered by 56 bipolar DC/DC converters, but which are not used because the beam orbit is good enough.

Table 1: SSRF booster power supplies parameter

Type	Number	L (mH)	R <sub>L</sub> (Ω)	Peak voltage (V)	Peak current (A)
B	2	121	0.232	1000	1150
QF	1	79	0.8	580	550
QD	1	57	0.64	475	585
SF	1	110	3.3	130	20
SD	1	101	3.1	170	30

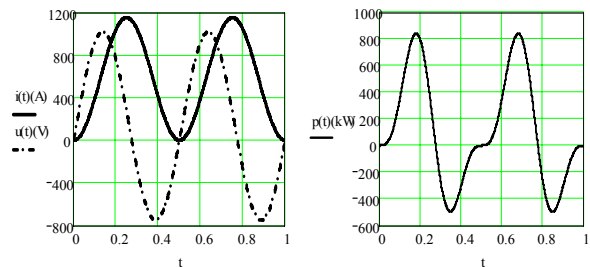

Figure 1: Theory operating curve of dipole power supply

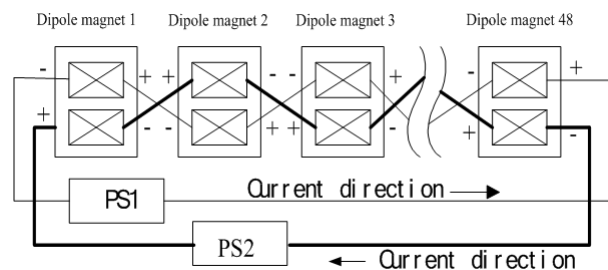

Figure 2: Two dipole power supplies connection

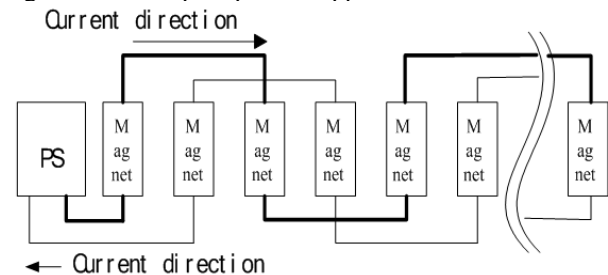

Figure 3: Booster power supply load connection

Much as 80kJ reactive energy flowing through the load should be stored in the capacitance for the next period used to avoid the energy to be flowed into power line. It is used 0.4F capacitance (separated 32 units) for a

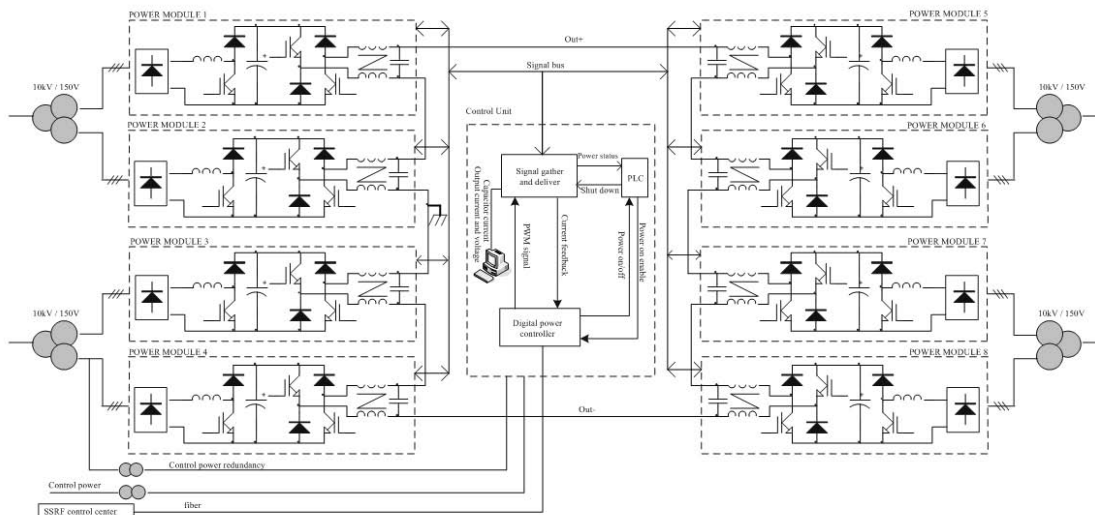

Figure 4: Dipole power supply structure [1]

single dipole power supply after optimized by simulation. The current of every unit is monitored by an industrial computer. An IGBT (FF450R12ME3) switch frequency is 10kHz drove by CONCEPT315 module. After phase shift, the output frequency can be 20kHz so that avoids noise and gets wider bandwidth. Four modules are in serial for 1000V as a branch and paralleled with other branch for 1150A, Figure 4. Two branches are burdened with current balance control, and a power supply is modularized into 9 cabinets. QD and QF are the same structure as that of dipole power supply.

**CONTROL STRATEGY**

The booster power supply has two independence control loops, input power control loop and two-quadrant converter control loop. The input power control loop is employed for avoiding fluctuation of power line, which is analog control loop, Figure 5. The two-quadrant converter control loop is a mixed digital and analog control loop, shown as in Fig6, which is two-quadrant converter with 2Hz biased quasi-sinusoidal current output.

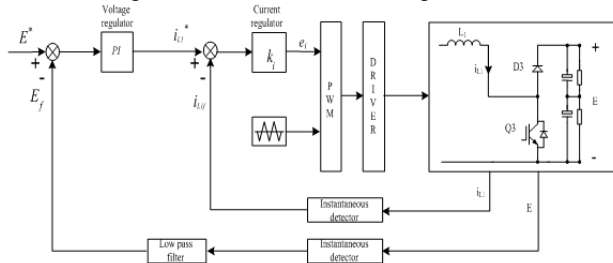

Figure 5: Input power control loop [2]

Figure 5 shows the booster power supply control loop for the input power control. There are two controlled variables. One is the current of input inductor,  $i_{L1}$  and another one is the voltage of booster output average,  $E$ . In fact, if  $i_{L1}$  is a constant current after feedback, the input power will be also constant. Because the load reactive

power will be stored into the capacitor during the load current reducing, the voltage over the capacitor will fluctuate at 2Hz rate. Only when the minimum value of  $E$  is bigger than the maximum value of input rectified voltage,  $i_{L1}$  will be controlled.

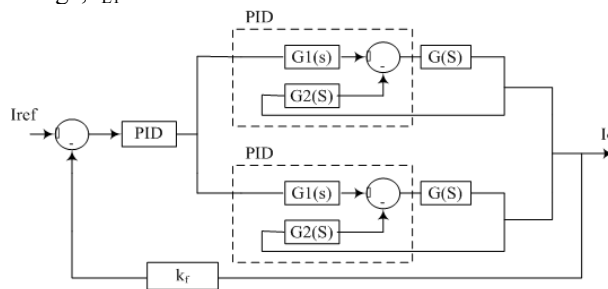

Figure 6: Two-quadrant converter control loop

The booster dipole power supply output peak current reaches 1150A. The two branches trace the same reference, Figure 6. The inner current is close feedback after compensated by PID, which works as an outer control object. We used a special PID for the outer current control loop [2].

**PRESENT**

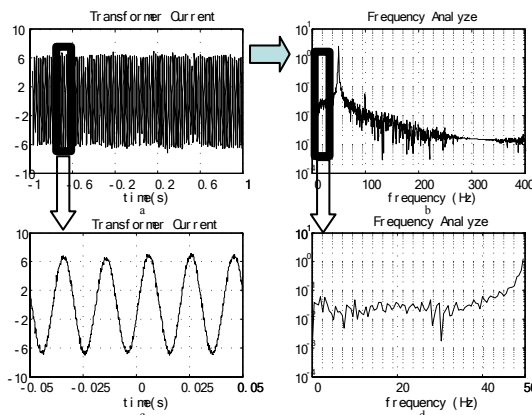

Figure 7: Dipole power supply input line current (output 1150A/1000V)

From Figure 7, there is no 2Hz harmonic in the input current. Figure 7\_a shows the primary current of the 10kV transformer captured by Tektronix 720P scope via a current sensor. Figure 7\_b is FFT of Figure 7\_a. Figure 7\_c and Fig7\_d is part of Figure 7\_a and Figure 7\_d in detail. So the inrush current caused by the 2Hz load inductance is reduced enough and got a high power factor 0.96 (acquired by FLUKE434), so the reactive power compensator is not needed.

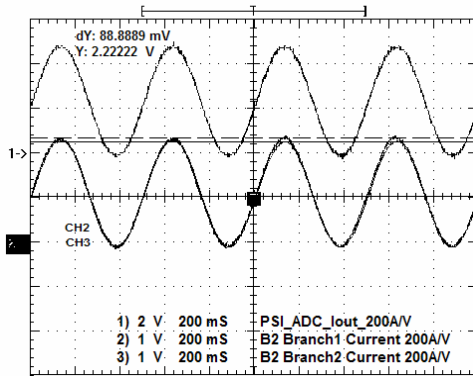

Figure 8: Parallel branch current

Figure 8 is the error between the parallel branches current which is less than 4%, the controller is simple and efficient.

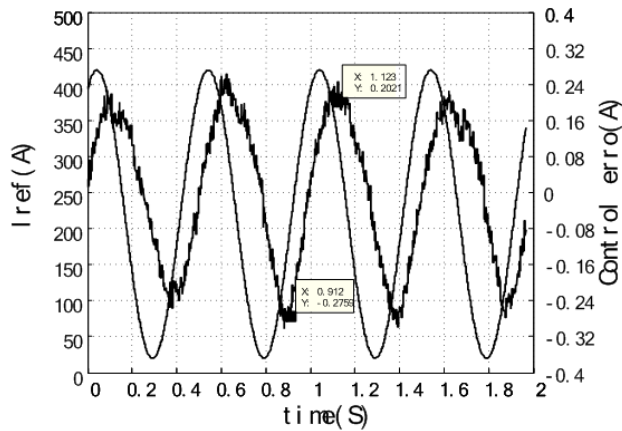

Figure 9: QD control error

Figure 9, due to the novel compensate method, the control error is less than 0.1% by just only current feedback [3] control.

### CONCLUSION

SSRF booster has been successfully running about 9 months, which proves that the booster power supply both in design and manufacture is sound, and proves the power supplies are stable and easy to be used.

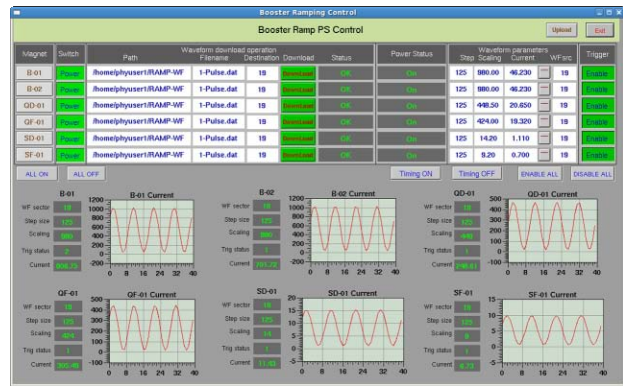

Figure 10: The interface of the booster power supply

### REFERENCES

- [1] DC-LINK CONTROL FOR A 1 MVA-3 HZ SINGLE PHASE POWER SUPPLY, F. Jenni, H.U. Boksberger, G. Irminger (PSI)
- [2] Lu Jialin, Luo Laiming, Shi Tao, Bai Xiaoqing, Li Rui, Shen Tianjian, and Li Deming, "A Novel Input Power Control Strategy for High-Power Booster Synchrotron Magnet Power Supply", CPSSC'2007, S9.9 , 289
- [3] Li, Rui; Lu Song-Lin; Chen Huan-Guang and Li De-Ming; "Novel PID technology used in 2 Hz dynamic switching power supply", Nuclear Electronics and Detection Technology, v 27, n 5, September, 2007, p 833-835