

## FIRST EXPERIENCE ON NEG COATED CHAMBERS AT THE AUSTRALIAN SYNCHROTRON LIGHT SOURCE

Brad Mountford, Australian Synchrotron, Melbourne, Australia

A. Conte, P. Manini, S. Raimondi, SAES Getters SpA, Lainate, Italy

### Abstract

The Australian Synchrotron is a 3 GeV third generation Light Source which has seen its first light in 2006. At full capacity it will house more than 30 beamlines providing state of the art facilities to support fundamental and applied research to the Australian scientific community. In the regional context, the Australian Synchrotron will also effectively complement the lower energy synchrotrons in Singapore (0,8 GeV) and Taiwan (1.5 GeV).

The vacuum system of the storage ring, 216m circumference, includes ion pumps and NEG cartridge pumps. Two NEG coated, ESRF style, aluminium insertion device vessels, each 2,5 m long, have been installed in the storage ring to increase machine parameters and broaden the spectrum and energy available for individual beamlines. A third aluminium chamber, 2 m long was also NEG coated and installed. Preliminary vacuum results obtained during conditioning and initial operation of the Insertion Devices are reported and compared to uncoated chambers.

### INTRODUCTION

Sputtered NEG films have been proposed by CERN [1] as a way to improve ultimate vacuum in high energy accelerating machines. 6 km of NEG coated chambers are installed at CERN in the straight warm sections of LHC [2] to mitigate e-clouds effects and about 500m of NEG coated straight sections at RHIC has already proved beneficial to reduce pressure instabilities and to remarkably increase machine luminosity [3,4]. NEG coated Insertion Devices (ID) are used by several 3<sup>rd</sup> generation synchrotron facilities [5], including Soleil, which has more than 50% of the total circumference coated [6]. NEG films reduce thermal out-gassing and provide large in-situ pumping speed, both features being ideal to improve vacuum conditions in conductance limited narrow-gap chambers, like insertion device vessels which are otherwise difficult to evacuate by ordinary means. Extensive use of NEG coated chambers has also the potential to reduce the conditioning time of synchrotron radiation facilities, as reported in this Conference [7]. NEG films can be fully activated at relatively low temperatures, like 250°Cx2 hrs. Even lower activation temperature for longer times (e.g. 180°Cx24

hrs) has been successfully applied in the case of aluminium chambers which cannot withstand high temperature bake-out.

The Australian Synchrotron, is a 3 GeV third generation Light Source, which complements the existing regional lower energy light sources in Singapore and Taiwan

The ESRF style NEG coated vessels were selected for use at the Australian Synchrotron due to their simplicity in design and demonstrated performance at other facilities. They provided a significant advantage due to the low profile of the extrusion which reduced the potential of interference issues with magnet keepers on the insertion devices. This allowed the vessels to be finalised and installed far in advance of the actual insertion device. Documented evidence on the performance of the vessels at other facilities in terms of vacuum conditioning due to the NEG coating and the subsequent reduction in related bremsstrahlung issues also made the chamber an appropriate design.

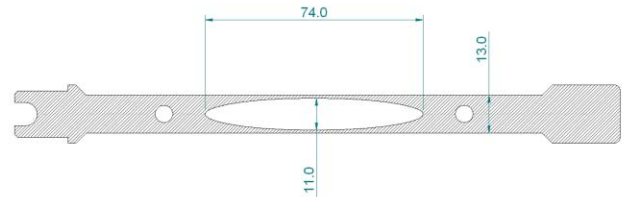

### CHAMBER PREPARATION

NEG coating of the aluminium vessels (grade T6060) was carried out in a vertical sputtering facility which can mount chambers as long as 6,5m [8]. Before mounting, chambers were cleaned with a suitable cleaning treatment developed at CERN [16]. Pre-cleaning of the chamber surface before coating is in fact essential to ensure adequate adhesion of the film to the substrate. Each chamber was fitted with three cathodes (made by twisting together Ti, Zr and V metal wires) mounted along the chamber axis. Cathodes spacing and relative positioning was adjusted by the view factor method [9] to achieve the most uniform thickness distribution profile along the perimeter. With the internal section being elliptical some thickness non uniformity is unavoidable, in spite of the use of multiple sputtering sources. In the best cathode configurations adopted, film thickness was comprised between 0,40 to 1,6 micron, as showed in Fig.1.

NEG film nominal composition was  $Ti_{30}V_{40}Zr_{30}$ .

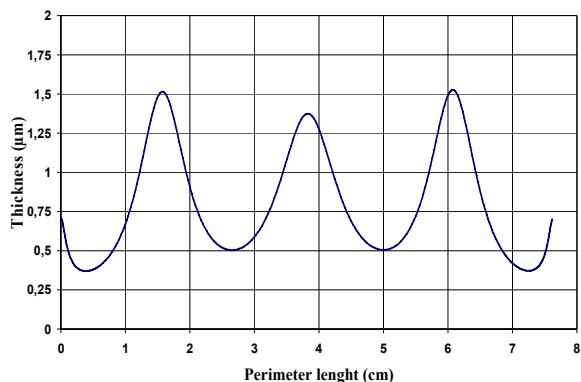

Figure 1: thickness distribution along the elliptical profile of the ASP chamber.

After preparation, chambers were mounted vertically to the manifold, evacuated and baked overnight at 120°C. An RGA was run to measure the gas background and ensure leak testing ( $<10^{-10}$  mbar/s).  $H_2$  and  $H_2O$  were always the main gases and no residue of the cleaning process nor traces of hydrocarbons were detected, this being a good indication of a properly cleaned surface.

Sputtering process was carried out at constant Kr pressure ( $\sim 0.015$  mbar). To get uniform coating up to the very end of the chambers, extension nipples having the same chamber cross section were flanged to the chamber extremities. A silicon test coupon was also mounted inside the extension chambers and analyzed to determine film composition and thickness.

Process parameters (cathodes currents and voltages, magnetic fields, plasma pressure, substrate temperature) were monitored during the deposition process. Special care was applied to optimize the process and avoid plasma instability problems which, especially for long, narrow gap devices, can occur and lead to less predictable film characteristics [10]. The 2m long magnetic coil (up to 700 gauss) was moved sequentially upward/downward to coat by steps all the chamber length

After coating, the chamber was inspected, aged for one day and then evacuated, filled with nitrogen and closed for shipment.

### CHAMBERS INSTALLATION AND VACUUM CONDITIONING

All mechanical assembly and fabrication of the vessels were carried out by FMB Berlin then delivered to site. Before installation in the storage ring the spool pieces and transitions which make up the remaining length of the straight section were baked to reduce the chance of cross contamination of the NEG vessel during activation. The basic components of a completed insertion device straight (Fig. 2) are a spool piece with ion pump followed by an RF transition to reduce impedance losses in the election beam, the NEG vessel is in the centre followed by another transition and spool piece.

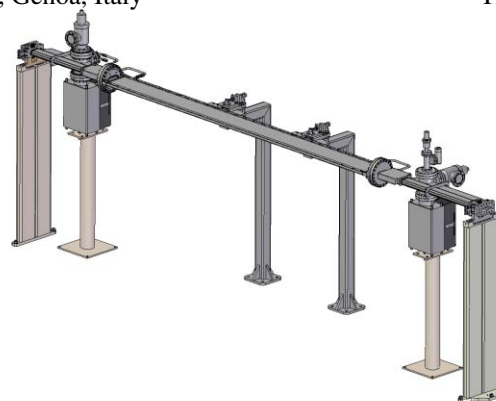

Figure 2: straight section assembly.

The entire straight section was brought to 100°C where the ion pumps were started for 1 hr. This is an effort to allow them to ‘burp’ any residual gases with the intention to remove them by the roughing carts before the NEG material is fully activated. The entire straight was then taken to 200°C for 12 hrs after which it was brought back to room temperature. Due to the thin chamber wall thickness in the centre of the vessel great care was taken to not over constrain the vessel and allow free expansion to reduce any unnecessary stress. The maximum ramp up and down temperature was 25°C/hr. After which a static base pressure below  $10^{-9}$  mbar was easily achieved within 24 hrs. The RGA plots showing the spectrum before activation followed by the spectrum after cool down is shown in fig. 3 and 4.

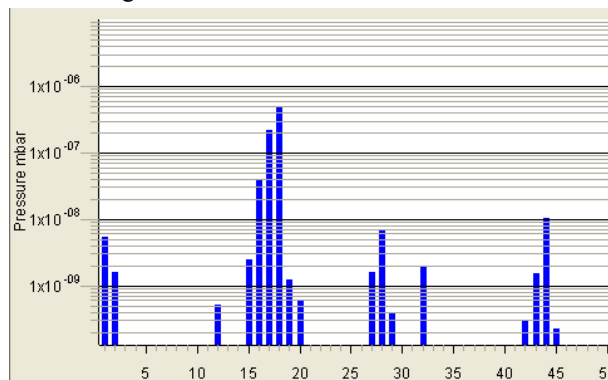

Figure 3: RGA up to mass 50 before activation.

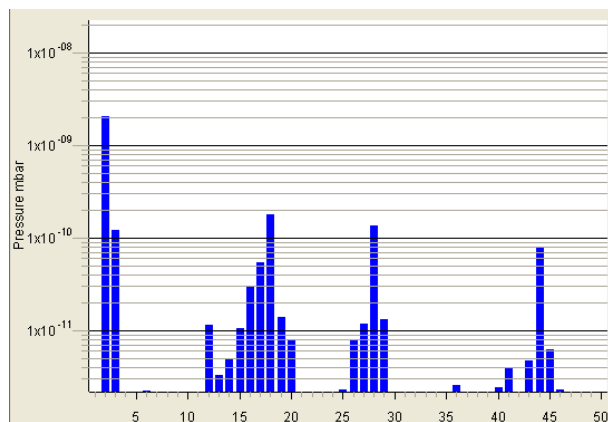

Figure 4: RGA up to mass 50 after activation.

All masses greater than 44 in the RGA plot were negligible which is an indication the chamber remained contaminant free during the installation.

## PRELIMINARY RESULTS

The ID vessels have been in service a cumulative total of 600, 630 and 683 Ahrs respectively without intervention. The following chart shows the conditioning of each vessel since installation in the storage ring.

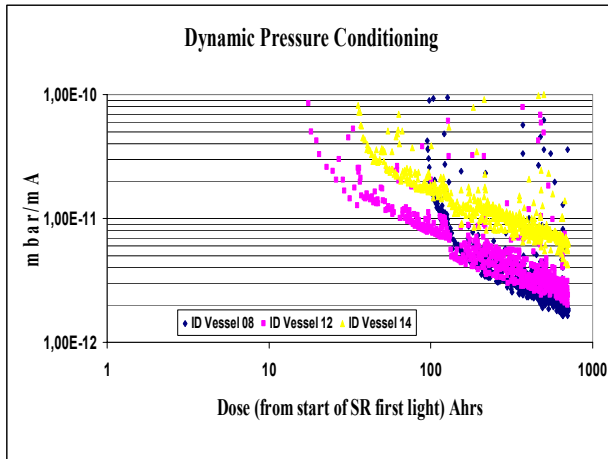

Figure 5: NEG coated vessels conditioning

Each new ID vacuum vessel replaces a standard straight section vacuum vessel. The following chart shows the average dynamic conditioning trend for two standard straight section vessels within the storage ring as a comparison.

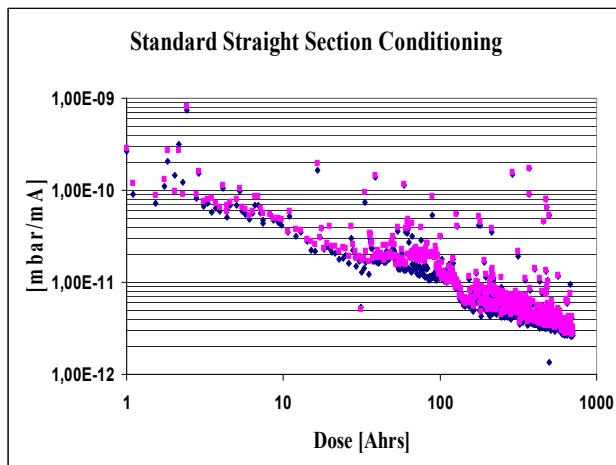

Figure 6: uncoated straight section vacuum vessel conditioning

It can be seen that the ID vacuum vessels conditioned rapidly to be of comparable dynamic base pressure at 700 Ahrs (total machine time).

Due to the fact that a vacuum gauge is not able to be located along the length of the ID vacuum vessel, the best

way to determine the conditioning of the vacuum vessel is indirectly by bremsstrahlung measurements the beam lifetime current product. The following chart plots the beam lifetime product since first light in the storage ring.

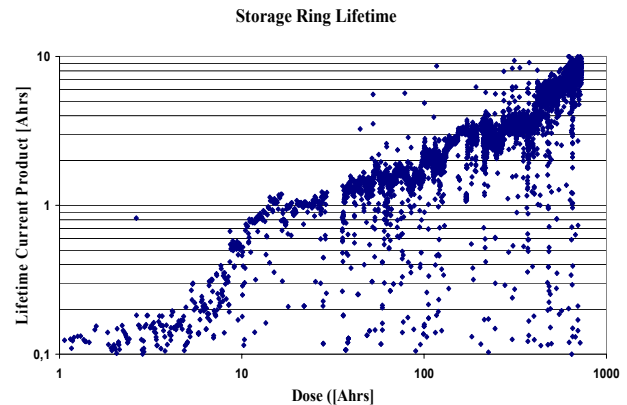

Figure 7: beam lifetime product since first light in the storage ring.

The first ID vacuum vessel was installed at 17Ahrs. It can be seen it had an immediate effect on the lifetime product of the electron beam. The installation of the subsequent 2 vessels at 35 and 100 Ahrs did not compound this effect. The initial conclusion is the ID vessels had an immediate effect on beam lifetime due to the restricted physical aperture in the storage ring. It is also assumed at this point that the vacuum quality within the NEG vessel is not detracting from beam performance. This is supported by the lack of an increase in measurable bremsstrahlung radiation. It is therefore concluded the vessels are performing as expected and are conditioning at a rate comparable to a standard straight section with the assistance of the NEG coating.

## REFERENCES

- [1] C. Benvenuti et al., *Vacuum* 53(1999), pp. 219-225.
- [2] P. Chiggiato, 41<sup>st</sup> IUVSTA Workshop, Brdo pri Kranju, Slovenia, 2004.
- [3] S.Y. Zhang. *ibidem*.
- [4] H.C.Hseuh et al, PAC 05 Conference Proceedings, Knoxville USA.
- [5] P. Manini et al., SRI 2006 Conference Proceedings, Daegu, Korea
- [6] C. Herbeaux, Workshop on "NEG Coatings and NEG Coated Vacuum Chambers for Synchrotron Radiation Sources", 2002 Daresbury, UK.
- [7] C. Herbeaux et al., EPAC 2008 Conference Proceedings, Genova, Italy
- [8] P. Manini et al, EPAC 2006 Conference Proceedings, Edinburgh, UK.
- [9] A. Bonucci et al., XVII Italian Vacuum Association Conference Proceedings, Ed. Compositori, 2005, pp. 93-98
- [10] A. Bonucci et al., PAC 07 Conference Proceedings, Albuquerque, USA.