

## A COUNTING MODULE FOR AN ADVANCED IONIZATION PROFILE MONITOR

D. Liakin, S. Barabin, A. Orlov, ITEP, Moscow, Russia  
P. Forck, T. Giacomini, GSI, Darmstadt, Germany

### Abstract

A new multi-channel counting module for advanced Ionization Profile Monitor applications has been developed. The module maximal performance concerning time resolution is about 10 beam profile measurements per microsecond at the cost of a slightly reduced spatial resolution with 80% accuracy (or better). Module architecture, basic modes of operation and the user interface are discussed. The results of first laboratory tests are also presented.

### IPM AND BIF BEAM PROFILE REGISTRATION METHODS

There is a class of methods which use very few residual gas molecules as a probe matter for non destructive beam profile detection. Fig. 1 shows schematically the operation of residual gas ionisation profile monitor (IPM)[1] on top and beam induced fluorescence (BIF) on the bottom.

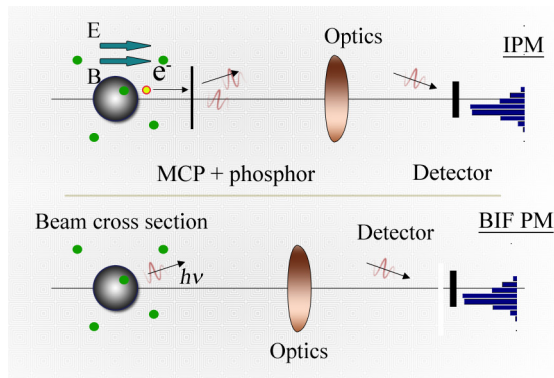

Figure 1: Principles of residual gas beam profile measurements. The IPM principle of operation is on top and BIF monitor on bottom.

Electrons or photons are casually emitted in collisions between accelerated beam particles and residual gas molecules. Properly guided they can be detected by position sensitive elements. Traditionally high resolution CCD devices are used as detectors. However these high spatial resolution devices can not be used for investigation of fast processes which are for instance a subject of interest during beam extraction or injection. To put new features into residual gas profile monitors, fast detectors like SiPMs or tube photomultipliers can be used in parallel with CCD cameras. In [2] one can find a consideration of using avalanche photodiodes in connection with fast photocurrent amplifiers for IPM systems. The factor which gives the preference to the photomultipliers and discriminators is an expected rate of

collision events which is more suited for a counting mode. Some features of fast operation modes also have been discussed in [2]. When using a CCD camera as a detector a signal amplification is required to get enough photons on the light sensitive matrix. In the case of IPM such amplification is provided by a MCP-phosphor assembly placed close to the beam, while the BIF monitors use an image intensifier in the near of a CCD matrix. For a fast profile detector which is operating in parallel to the classical CCD this means different operation modes: true single photon registration in the case of BIF and photon cluster detection in the case of IPM. No hardware modification is required to switch between these modes.

### STRUCTURE OF THE MODULE

The module layout is shown on Fig. 2. The small dimensions, enforced case and minimal connection requirements allow to install the counting module outside of electronics room close to the light detector itself.

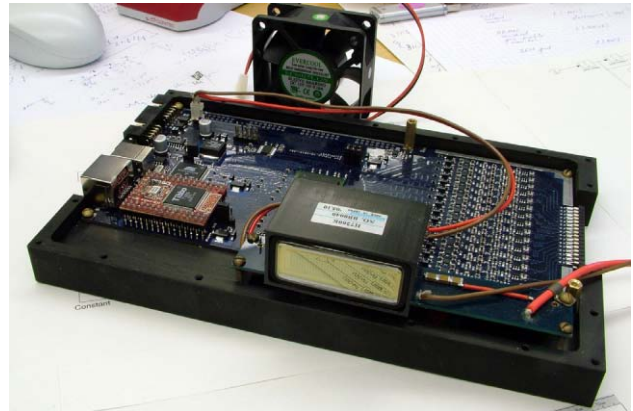

Figure 2: Picture of the multichannel counting module.

Initially it was assumed that this module will operate in combination with multichannel photomultiplier tubes (PMT) or silicon photomultiplier (SiPM) array – detectors which are producing output pulses with similar timing and amplitude parameters. Both types of detectors can be connected either over moderate length 50 Ohm transmission line bundles or directly onto amplifiers input. In most cases the detectors output pulse timing parameters are sufficient for 5ns double pulse recognition (see Fig. 5).

More detailed the module structure is shown on Fig. 3. It includes 32 discriminator lines, an FPGA for fast on-line data processing and buffering, a powerful 32 bit ARM-based microcontroller and Ethernet controller as a basic communication standard for a host computer connection. The counting module also includes a high

voltage power supply required for PMT operation. An optional digital processor module can be connected over the high performance 32-bit bus or by using several channels of a fast serial interface.

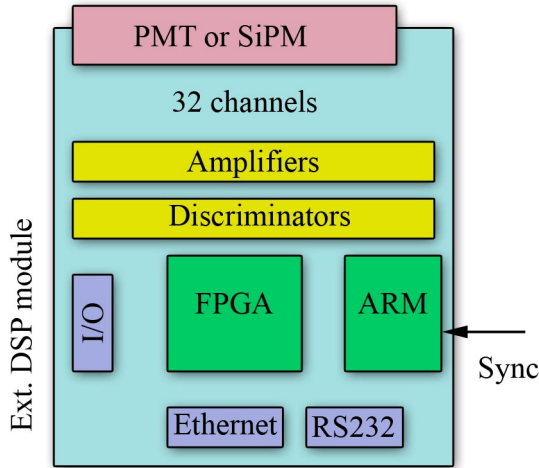

Figure 3: The internal structure of the counting module.

Each of the analog paths includes an amplifier (AD8009), a low-pass filter for noise reduction and a fast comparator with differential output (ADCM604). The signal amplification allows to use a lower relative threshold level. Due to the high sensitivity of the electronics a long cable bundle can be used to move the counting module out of the radiation hard conditions.

### MODES OF OPERATION

Presently the fast readout mode of the IPM is under development. In these conditions the onboard FPGA gives flexibility in the data processing algorithm selection which can be changed without hardware modification. Nevertheless Fig. 4 shows three basic foreseen operation modes for the counting operation.

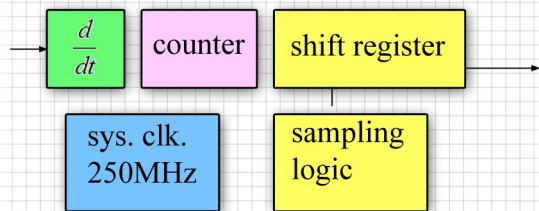

Figure 4a: Simple counter/slicer operation mode. The burst mode provides up to 10M slices per channel per second.

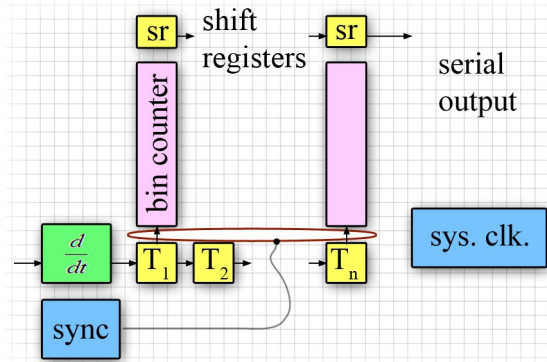

Figure 4b: A histogram mode is dedicated to periodic or recurring processes.

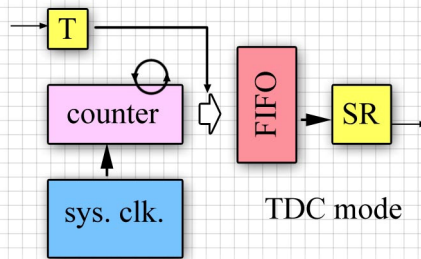

Figure 4c: A most comprehensive time to digital converter (TDC) mode in connection to the DSP gives highest possibilities in on-line data processing.

In the counter mode shown in Fig. 4a the module is operating as a traditional profile readout device. The profile data is accumulated in the dedicated counters. The integration time is variable and can be established as short as 0.1  $\mu$ s. This integration/sampling time in combination with a high input pulse rate allows draft estimate beam profile on bunch by bunch basis. For periodic or repetitive processes one can use a histogram building with  $\sim$ 10ns or longer bin size. This mode allows an investigation of a fine time structure especially in BIF applications where is no intermediate converter like a relatively slow phosphor. For the IPMs with a 100ns decay time phosphor and up to  $10^8$  photons per event the counter module can operate as a macropulse counter, when 10..100 photons from single event produce a single pulse of current on the PMT output. Nevertheless the performance of the counter also allows detection of these photons separately. In this case the data should be clustered in 'macropulses' by data processing algorithms. For such and similar situations, when an extensive preliminary calculation can improve the module performance, a direct data flow to an external DSP module is foreseen as an optional mode of operation. For the applications with high data memory consuming algorithms this option is also used.

### INPUT DATA STRUCTURE

The output of a photomultiplier is shown in Fig. 5. One can see a broad spectrum of amplitudes placed along the left axis.

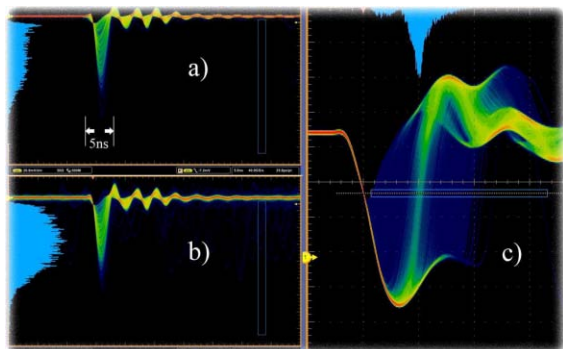

Figure 5: Amplitude spectra of dark count pulses (a) and pulses, produced by incident photons (b). (The integration time is not equal). The right part (c) shows the pulse width distribution on the control FPGA output.

As it can be seen a remarkable number of pulses have low amplitude. Therefore usage of any discrimination by level will lead to certain efficiency degradation due to the missing of pulses having amplitudes below the threshold level. The chosen value for the threshold guarantees a registration of 90% of the PMT or SiPM pulses. Another side effect of pulse discrimination is an output pulse width modulation as it is seen in Fig. 5.

## MODULE COOLING

The counting module has been designed as a small form-factor device to gain the possibility to place it close to light detector. At the same time a high throughput rate requires the usage of power consuming RF amplifiers and comparators. A dense assembly of 32 discriminator channels produces significant self-heating effect with local temperatures exceeding the upper operating temperature limit of used semiconductor devices. A simplified 2D-simulation of forced convectional cooling of the printed board shows acceptable results (20° C over the ambient temperature) for 3m/s air flow velocity which is provided by cheap commercial cooling fans.

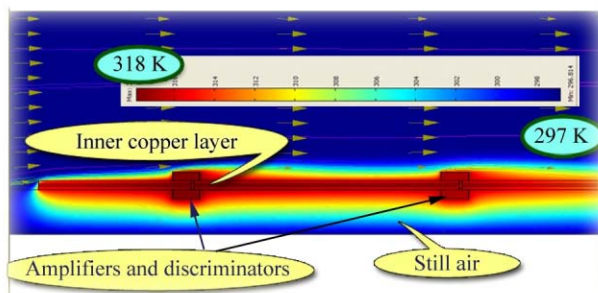

Figure 6: Simulation of the thermal map in the case of forced convectional cooling.

## FIRST TESTING RESULTS

The counter module has been tested with a multichannel photomultiplier to check the dynamic range and the electrical and optical performance of the system. Fig. 7 presents some results of DC tests of the PMT-counting module assembly. As expected, it shows an

excellent linearity in the wide range of light intensity, sufficient uniformity of the gain coefficient and low crosstalk between adjusted channels. The dark counts of the PMT were measured in the range of a single pulse per second. In contrast the SiPM shows much higher background at room temperature conditions, which moves SiPMs out of IPM applications.

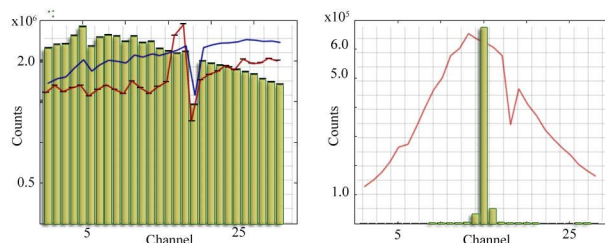

Figure 7: The pulse distribution histogram for uniform PMT surface illumination (left). The image of the focused pin light source (right).

## AVAILABLE EXTENSION MODULES

As it was mentioned above an additional DSP module is available. This two-core 600MHz DSP is equipped with 128MB SDRAM for continuous time operation.

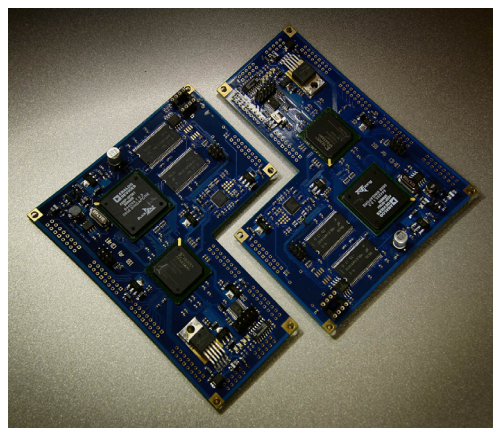

Figure 8: DSP extension modules.

## REFERENCES

- [1] P. Forck et al. "Advanced residual gas profile monitor for high current synchrotrons and cooler rings", DIPAC03, Mainz, Germany, PM17, p134
- [2] D. Liakin et al. "Development of a permanent magnet residual gas profile monitor with fast readout" in proc. EPAC04, Lucerne, Switzerland, 2004, THPLT100, 2724