

GROUNDING AND INDUCED VOLTAGE ISSUES OF THE INJECTION BUMP MAGNET SYSTEM OF THE 3-GEV RCS IN J-PARC

T.Takayanagi[#], T.Ueno, M.Kinsho, M.Yoshimoto, J.Kamiya, M.Watanabe, JAEA/J-PARC[#], Tokai-mura, Naka-gun, Ibaraki-ken, Japan
Y.Irie, KEK, Tsukuba-shi, Ibaraki-ken, Japan

Abstract

The power supply of the shift bump magnet (BUHS) [1] [2] is composed of the assemblies that are multiple-connection with IGBT (Insulated Gate Bipolar Transistor) choppers. The switching frequency of them is controlled over 48 kHz. The high-frequency noise due to the switching of the IGBT choppers has caused the damages to the control system. Furthermore, the capacitors for the RF shield of the ceramics chamber inside the BUHS have been burned by the induced voltage due to the fast falling time of the current pattern and the current ripple of the high frequency.

The ground wires that connect to each power supply panel and each magnet has been changed to copper sheets and the neutral ground (ME) resistor of the IGBT assemblies have been installed. So that the voltage due to the switching noise has been decreased from 900 V to 24 V. The Low-pass filter of 72 kHz has been installed to output circuit and the falling time of the current pattern was changed to be slow. The burning of the capacitor was controlled.

STATUS OF THE 3-GEV RCS

The Japan Proton Accelerator Research Complex (J-PARC) accelerator [3] [4] consists of 181 MeV Linac, 3-GeV rapid cycling synchrotron (RCS), and 50-GeV synchrotron (MR). The RCS accelerates the proton beam from the Linac up to 3 GeV and extracts to the MR and the materials and life science experiment facility (MLF).

The 181 MeV proton beam from the Linac has been successfully injected into the RCS and circulated on October 26th in 2008. Furthermore, the acceleration up to the design energy of 3 GeV and the extraction to the beam dump has been achieved after 5 days on October 31st.

INTRODUCTION

Four shift bump magnets (BUHS01-04) produce a fixed main bump orbit to merge the injection beam from the Linac into the circulating beam of the RCS [5] [6]. The four magnets are connected in series and the excitation timing error of each magnet is negligible.

The power supply of the shift bump magnet excites the large pulse current of 20 kA with a repetition rate of 25 Hz. The tracking error less than 1 % and the fast falling time less than 200 μ s are required [2] [6]. The component of the power supply has adopted the IGBT choppers with a multiple-connection. A rated operation for 24 hours was confirmed that there was no problem in the factory (20 kA, 25 Hz). However, the operation was not completed

on the RCS building. The improvement of the ground system has been done, and the noise due to the switching of the IGBT choppers was decreased. Furthermore, a Low-pass filter and the changes in the current pattern were needed to control the burning of the capacitors for the RF shield of ceramics chamber.

THE SHIFT BUMP POWER SUPPLY

The shift bump power supply is composed by multiple-connection of the IGBT choppers. The circuit is shown in Fig.1. The composition of the main circuit is rectifier panels (REC) of 4 steps and IGBT chopper panels (CHP) of 7 parallels. One chopper panel of them is composed of 4 multiple assemblies. The chopper panels that stood in a line are connected in series, and 8 multiple assemblies are adopted. Each assembly has 3 parallel IGBT choppers with two-quadrant. So the total number of the assembly is 56 and the parallel number of the IGBT choppers is 21. Each chopper panel is called CHP2A to 2G and CHP3A to 3G, respectively.

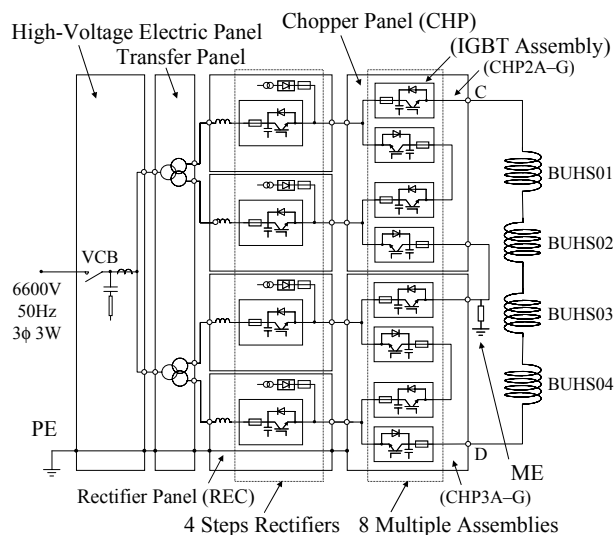

Figure 1: Circuit of the shift bump power supply.

The elementary frequency of the IGBT choppers is 6 kHz and the controlled switching frequency of the 8 multiple assemblies is 48 kHz. The neutral point of the IGBT choppers between the positive side (C) and the negative side (D) is grounded (ME). The IGBT chopper is a type of 3300V-1200A and the total output voltage is controlled by 6400 V or less than. The specifications of the power supply are shown in Table 1.

The power supply panel is composed three rows, and the chopper panel would be increased 1.6 times in the case of the 400 MeV upgrade. One panel of them is

[#]takayanagi.tomohiro@jaea.go.jp

composed of a high voltage electric panel, four rectifier panels (REC21-22, REC31-32) and ten chopper panels (CHP2A-2E and CHP3A-3E). And two other panels are a control panel (CTL) and only four chopper panels (CHP2F to 2G and CHP3F to 3G), respectively.

Table 1: Specifications of the power supply

Items	Parameter
Maximum Current	20 kA
Repetition Rate	25 Hz
Element of the IGBT module	3300V-1200A
Rectifier and Assembly	4 steps and 8 multiplex
Composition of the choppers	21 parallels
Switching Frequency	48 kHz
Power Cable Type	6.6 kV EM-CEQ 38 mm ²

IMPROVEMENT OF THE GROUND

The potential difference due to the switching noise was investigated. The voltage between the frame ground (PE) and the ground was over 900 V, and the voltage between each power panel was over 150 V. The power supply became unstable, and repeated faulty operation.

Changes in the Ground Wire

The frame of each three panel was connected with a short ground wire, which the length is less than 2 m and the diameter is 100 mm². Moreover, the total length of the ground wire is 120 m between the power supply of the underground in the RCS building and the ground pole outside of the building. Then, it is 80 m more between the power supply and the magnet in the main tunnel. All ground wires were changed to the copper sheets (W300 mm × T1 mm), and furthermore the layout of the wiring route was changed to be the shortest distance that is 125 m, too. Consequently, the voltage between each power panel was less than 24V and the high-frequency noise of the control device and the monitor was decreased.

Processing of the Power Cable Shield

The power cable of the power supply is used a twisted-pair cable of four a couple (see Fig.2). The opposite lines are connected with same polarity, and the radiation noise and the cable inductance are decreased.

When the shield line is connected with the ME, the exciting current was unstable. So the connection of the shield line has been changed to the frame ground, the noise was decreased.

Dependence on the Neutral Ground Resistance

The relation of the current of the ME and the resistance of the ME were investigated by insulating a resistor of various parameters between the ME and the ground. The measurement result is shown in Fig.3. When the resistance is 200 Ω, the potential difference and the ME

current have been become small. The exciting current has been steady, and the noise has decreased.

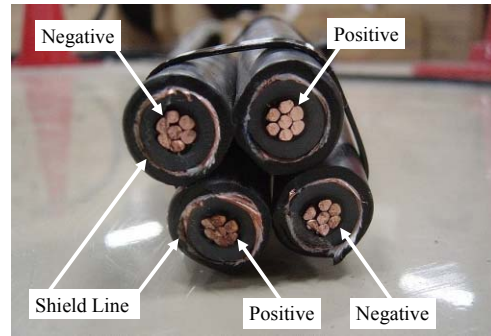

Figure 2: Power cable of the shift bump power supply. (6.6 kV EM-CEQ 38 mm²)

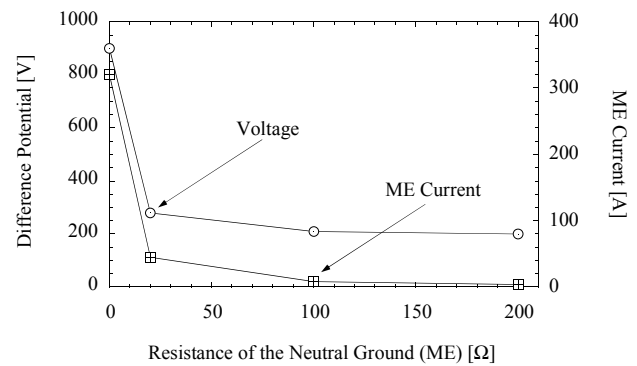

Figure 3: Measurement result of the voltage and the current when changing the neutral resistance.

BURNING OF THE CAPACITORS AT THE CERAMICS CHAMBER

There are the chip capacitors of the RF shield at the ceramics chamber inside the shift bump magnet [7]. The capacitors were burned by the induced voltage due to the falling time of the current pattern and the current ripple of the switching at the IGBT choppers. Especially, the capacitors with the side where the area of the shield loop was large were often discharged. The ceramics chamber with the capacitors and the equivalent circuit of the RF shield loop are shown in Fig.4 and Fig.5, respectively.

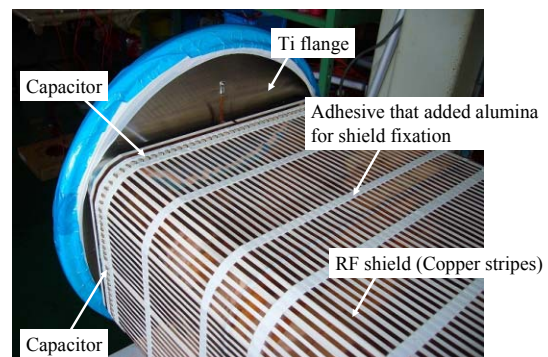

Figure 4: Ceramics chamber of the shift bump magnet.

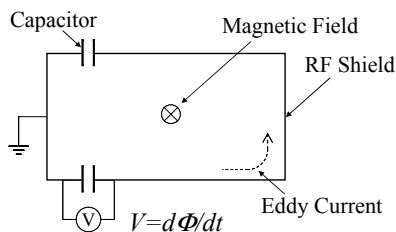

Figure 5: Equivalent circuit of the RF shield.

Measurement of the Voltage at the Capacitor of the RF Shield

Some kinds of the current pattern, which the falling time was different, were supplied. The induced voltage was measured at the gap where the capacitors were removed. The measured waveforms of the voltage and the exciting current are shown in Fig.6. And so the measurement result is shown in Fig.7, where the voltage is the peak-to-peak and time (185 μs, 400 μs and 500 μs) is a falling time of the current pattern. There occurred flashovers at the gaps when the voltage was about 400 V. The voltage rating of the capacitor is 250 V ± 20 %.

The dotted lines show the results that calculated using the current pattern (refer to next chapter). The experiment result hasn't agreed with the calculations. The control of the exciting current that is quite small is difficult and the current that can't be controlled is excited without becoming a zero. Furthermore, the current ripple due to the switching of the IGBT choppers generated the induced voltage. Therefore, the extrapolation value of the voltage at a zero current hasn't become a zero.

However, the coefficient of the linear function has been good agreement. It has been shown that it depends on the induced voltage of the shift bump magnetic field.

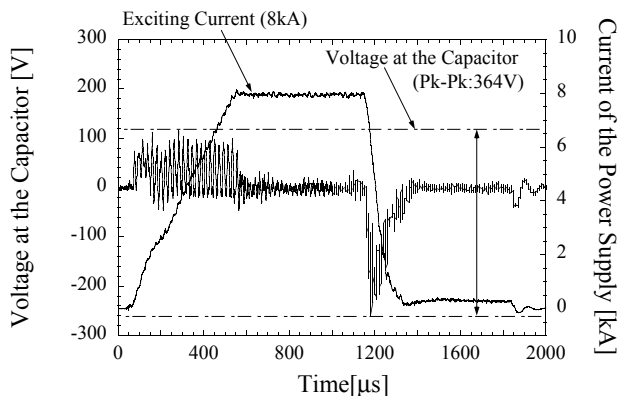

Figure 6: Voltage at the capacitor and exciting current.

Calculation of the Induced Voltage

It is assumed that the induced voltage by the magnetic field generated in the loop of the RF shield is equal to the voltage across the coil of one turn. The induced voltage in each magnetic field that depends on the current pattern is calculated from the following parameters. Table 3 shows the result of the typical numerical value.

- $V=d\Phi/dt$: Voltage is in inverse proportion at the amount of time change.
- Rating current and voltage: 20 kA at 6400 V
- Time when a voltage becomes the maximum: 185 μs
- Maximum voltage per 1 turn coil: 800 V

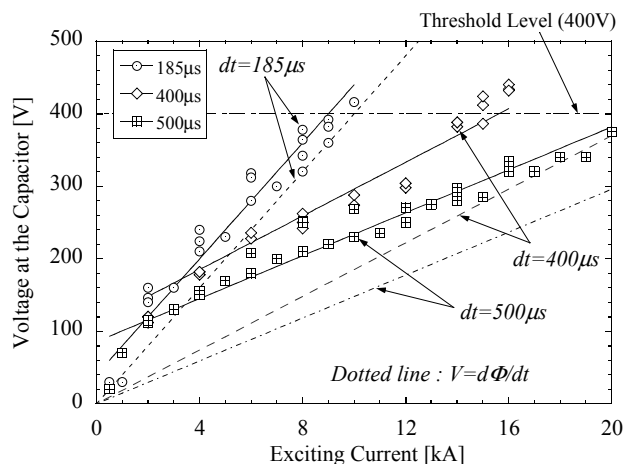

Figure 7: Measurement Results of the Voltage at the RF shield terminal of the capacitor.

Table 3: Relation of the induced voltage and the change time of the current pattern.

Current	185 μs	400 μs	500 μs
1 kA	40 V	18.5 V	14.8 V
20 kA	800 V	370 V	296 V

SUMMARY

IGBT choppers with multiple-connection are applied as the switching power supply for large current and high precision pulse current. However, when the number of switching device increases, the damage with noise of the high frequency is given to the system. In that case, the problem is improved by reinforcing the ground-line system.

Furthermore, the induced voltage of the RF shield that is dependent on the magnetic field and the current pattern has been confirmed.

REFERENCES

- [1] T.Takayanagi, et al., Proceeding of EPAC 2006, TUPLS111, p.1762-1764.
- [2] T.Takayanagi, et al., IEEE Trans. Appl. Supercond., vol. 16, no.2, p.1366-1369, Jun. 2006.
- [3] High-intensity Proton Accelerator Project team, JAERI-Tech, 2003-044, March, 2003.
- [4] <http://j-parc.jp/index-e.html>
- [5] T.Takayanagi, et al., Proceeding of PAC 2005, Knoxville, Tennessee, p.1048-1050.
- [6] T.Takayanagi, et al., IEEE Trans. Appl. Supercond., vol. 16, no.2, p.1358-1361, Jun. 2006.
- [7] M.Kinsho, et al., Vacuum, 73, 2004, pp.187-193.