

# DESIGN CONSIDERATION OF THE RF DEFLECTOR TO OPTIMIZE THE PHOTO INJECTOR AT PITZ\*

S. Korepanov<sup>#</sup>, S. Khodyachykh, M. Krasilnikov, A. Oppelt, F. Stephan, DESY-Zeuthen, Germany  
 V. Paramonov, INR, Moscow, Russia.

## Abstract

In order to optimize photo injector for Free Electron Laser (FEL) applications, a detailed characterization of the longitudinal and transverse phase space of the electron beam provided by the Photo Injector Test Facility at DESY in Zeuthen (PITZ) is required. In the paper we present design considerations of the RF deflecting cavity for transverse slice emittance and longitudinal phase space measurements.

## INTRODUCTION

The main research goal of PITZ is the development of electron sources with minimized transverse emittance [1]. The current setup at PITZ permits us to measure transverse emittance averaged along a bunch using the Emittance Measurement System (EMSY) [2]. With the use of an RF deflector it is possible to analyse the slice transverse emittance. Adding a dispersive arm the longitudinal beam phase space can be completely reconstructed.

At PITZ2 the application of an RF deflector is planned. The deflector position is about 9 m from the gun. The next 3.5 m space is taken by a tomography module, which will be used for transverse phase space measurements. At about 15.5 m a spectrometer based on dipole magnet is positioned.

In Fig. 1 the effect of the RF deflector is illustrated: the RF deflector voltage is null in the longitudinal centre of the bunch and gives a linear transverse deflection to the bunch itself. The maximum displacement of the edge slice  $Y_B$  can be estimated by the expression

$$Y_b = \frac{\pi \cdot f_{RF} \cdot L \cdot L_B \cdot V_{\perp}}{c \cdot E / e}, \quad (1)$$

where  $f_{RF}$  is the frequency of the deflecting voltage,  $V_{\perp}$  is the peak transverse voltage,  $L$  – drift space after the deflector, and  $E$  is the beam energy in eV units [3].

The resolution length  $L_{res}$  can be estimated as the bunch length  $L_B$  divided by the number of slices  $N_{slices}$  which can be resolved at the screen. And the number of the slices is  $Y_B$  divided to transverse beam size  $\sigma_B$ .

$$L_{res} = \frac{L_B}{N_{slices}} = \frac{L_B \cdot \sigma_B}{Y_B} = \frac{\sigma_B \cdot c \cdot E / e}{\pi \cdot f_{RF} \cdot L \cdot V_{\perp}} \quad (2)$$

\* This work has been partly supported by the European Community, contracts RII3-CT-2004-506008 and 011935, and by the ‘Impuls- und Vernetzungsfonds’ of the Helmholtz Association, contract VH-FZ-005

<sup>#</sup> sergey.korepanov@desy.de

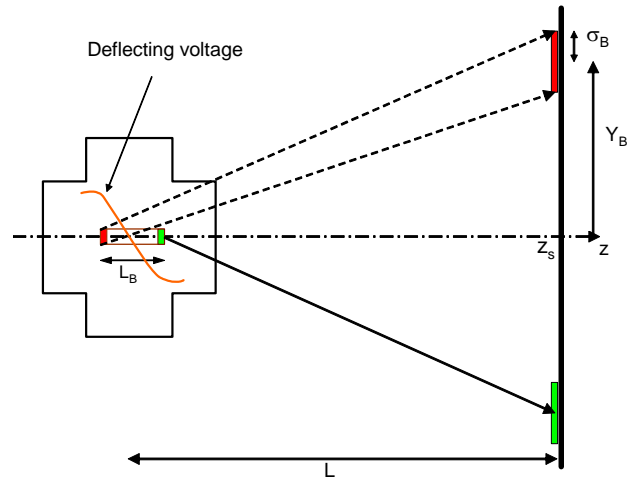

Figure 1. The principle of the RF deflector work.

For the prospect beam parameters at PITZ2 (Table 1) the possible resolution length is limited by the transverse size of the screen ( $< 36$  mm) and minimum transverse beam size ( $\sigma_B \sim 1.6$  mm). That gives the maximum number of the slices about 20 and the longitudinal resolution length about 0.4 mm (1.3 ps).

Table 1. PITZ2 beam parameters.

bunch charge	1 nC
max. long. momentum	32 MeV/c
min. norm. emittance (rms)	$< 1 \pi$ mm mrad
transverse beam size on screen in tomography module, rms (full)	$< 0.4$ (1.6) mm
full longitudinal beam size	8 mm (27 ps)
pulse frequency	1-9 MHz
repetition rate	10 Hz

## RF DEFLECTORS

For PITZ2 diagnostics we have reviewed three kinds of RF deflectors. Two of them are steady wave resonators and one is a travelling wave cavity. We analyzed electron beam parameters after passing the cavity and compared the results for the different deflectors.

### Steady wave cavities

We have chosen the well known cavity which is a disk loaded waveguide [3]. It has five cylindrical cells. We scaled it to the frequency 1.3 GHz, Fig.2a. This cavity

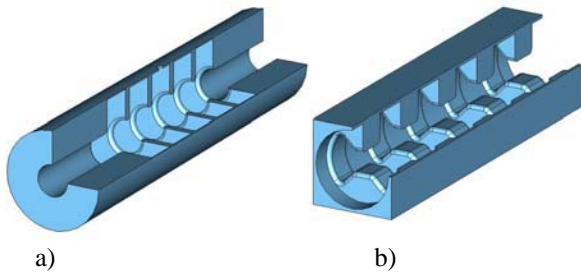

Figure 2. General view of “classical” cavity (a) and “Paramonov” cavity (b).

operates with TM11 mode. Another steady wave cavity is a new one designed by V. Paramonov. The shape of the structure is shown in Fig.2b. It operates in TE11 mode. More details about this cavity are given in [4].

*Travelling wave cavity*

The third cavity is based on LOLA-IV - transverse deflecting cavity [5], Fig.3. We have adapted it for our beam: scaled it from 2.856 GHz to 1.3 GHz and changed length from 3.6 m to 0.7 m. It has 9 cells and two additional cells for coupler and load.

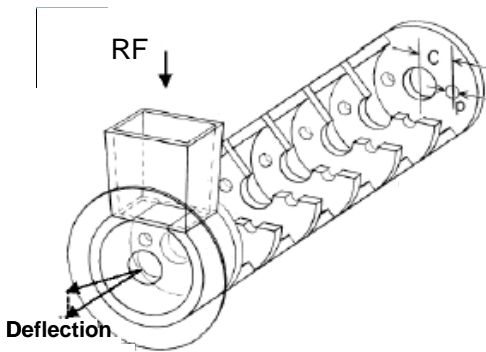

Figure 3. Travelling wave cavity based on LOLA-IV.

In the Table 2 we compare the deflector parameters for two operations regimes - to analyse the longitudinal phase space at a distance of about 6 m from the deflector in the dispersive arm and – to observe the beam at the first screen in tomography module at a distance of ~ 2 m

Table 2. Deflector parameters.

	Classic cavity		“Paramonov” cavity		Travelling wave cavity	
Frequency GHz	1.3	1.3	1.3	1.3	1.3	1.3
Distance, m	2	6	2	6	2	6
$V_{\perp}$ , MV	1.8	0.6	1.8	0.6	1.8	0.6
Q	21000	21000	15000	15000	19000	19000
$P_{RF}$ , MW	2	0.12	0.17	0.02	9.1	1.01
Field						
build up, $\mu$ s	~20	~20	~20	~20	~0.2	~0.2

from the deflector. In the table Q is unloaded quality factor, “Field build up” is the time which field needs to reaches about 99% of there maximum value [5].

**BEAM DYNAMICS**

Beam dynamics simulations have been performed for comparing the cavities presented above. For our simulations we use a beam with the parameters: average energy 32 MeV, energy dispersion 140 keV, transverse beam size about 0.7 mm, transverse emittance -  $0.9 \pi$  mm mrad. The beam is passing through the deflector and is observed at the points of screens positions in the tomography module and in the dispersive section after the dipole.

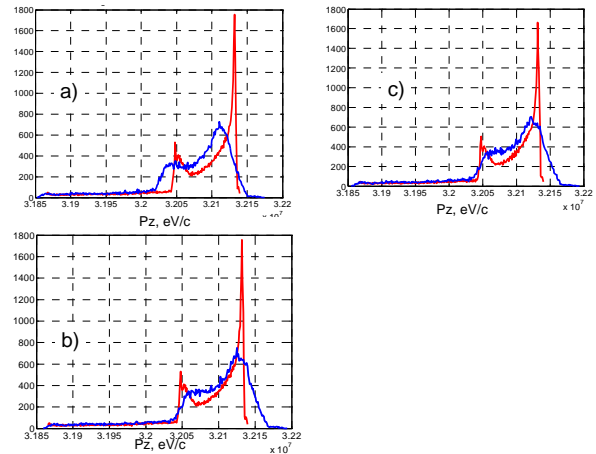

Figure 4. Longitudinal momentum distribution.

Red line corresponds to the initial distribution (before deflector).Blue line is the distribution for the beam passed through a)“classic” cavity, b) “Paramonov” cavity, c) traveling wave cavity.

For correct longitudinal phase space measurements in the dispersive arm we have to minimize distortion of the longitudinal momentum distribution during passing the deflector. We compared the longitudinal momentum distribution on the dispersive arm screen for the different deflectors. In Fig.4 momentum distributions for the three variants of the deflectors are compared with the initial momentum distribution (before deflector). One can not see large difference between these three cases. The estimated resolution of the method is about 25keV/c. This value we can roughly resolve from the presented distributions. The rise or fall edge in the initial momentum distribution is about a few keV. They are transformed to the edges with the width of about 25 keV.

The transverse slice emittance measurements require high similarity of the initial longitudinal charge distribution to the transverse charge distribution (along deflecting direction) after deflector. This requires a lineal dependence of the deflecting voltage to the position inside the bunch. The requirement is provided by a quite large RF wave length (230 mm) in the cavities in comparison with the bunch length (8 mm). Beside that the cavity has to generate a minimum distortion in the transverse

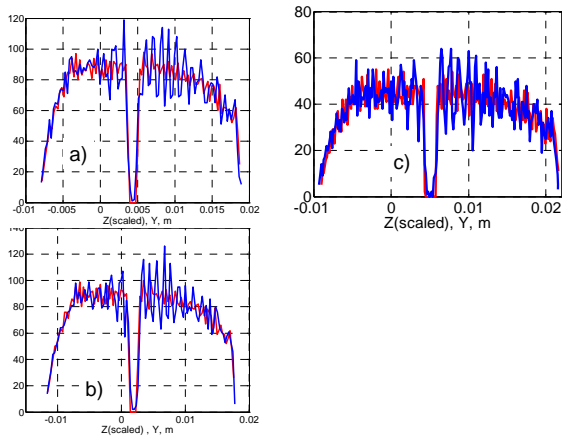

Figure 5. Charge distributions.

Red line corresponds to the initial longitudinal distribution (before deflector). Blue line is the transverse distribution in the deflected direction for the beam passed through a) “classic” cavity, b) “Paramonov” cavity, c) traveling wave cavity.

direction (perpendicular to deflected direction). This is necessary for correct emittance measurements. In Fig.5 we compare the longitudinal charge distribution of the initial beam and transverse charge distribution for the beam passed through deflecting cavity. We add a special gap (0.4mm) in the initial distribution in our simulations. That helps us to estimate the resolution length by observing the gap in the transverse distribution of the

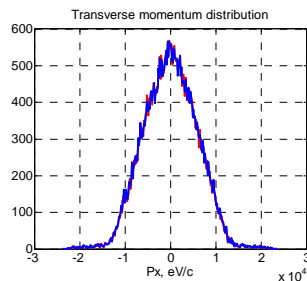

Figure 6. Transverse momentum distribution (perpendicular to deflect direction). Red line – initial distribution (before deflector), blue line – distribution for the beam passed through traveling wave cavity

deflected bunch. One can see that all cavities provide transverse bunch charge profile (corresponds to deflected direction) similar to the initial longitudinal charge profile. Because of the 100 % degree of the modulation in the final distribution we can estimate that the resolution length for these measurements is about the gap width (0.4 mm). The transverse momentum distributions (perpendicular to deflection direction) practically are not changed in the deflector. An example of the transverse momentum distribution before and after the deflector is shown on Fig.6 for the travelling wave cavity. The simulations show minimal influence from the deflectors to transverse beam parameters (perpendicular to deflection direction).

## DISSCUSION OF THE RESULTS

All presented cavities can be used for the beam phase space analysis. We have considered their advantages and disadvantages. The main differences are between steady wave and travelling wave cavities. The first one request less RF power (see Table 2) and is easy in control. But the travelling wave cavity gives us a possibility to analyse a single bunch in a bunch train. We plan to work with the beam bunch repetition frequency up to 9 MHz (period ~0.11 μs). Because of short filling time in travelling wave cavity (0.2 μs) we can “take” a single bunch and direct it to a screen and distort 1-2 other pulses in the train only. This possibility is important for the analysis of the beam parameters fluctuation in the train from bunch to bunch. Also we can make the beam monitoring during tuning the beam. We decided to use the travelling wave cavity in combination with the tomography module for the possibility to analyse single bunches.

## DIAGNOSTIC COMPLEX FOR LONGITUDINAL SLICE TRANSVERSE EMITTANCE MEASUREMENTS

The layout of the prospect system for slice emittance measurements is shown in Fig.7. It contains a deflecting cavity, a tomography module and four kickers. The beam is matched by quadrupoles on the entrance of the tomography section so that  $\alpha$  and  $\beta$  functions are periodically repeated from screen to screen [6]. That permits us to analyse the beam more easily. The bunch deflected in the RF cavity in vertical direction is deflected by the kicker in horizontal direction to the screens. The screens are located off axis. The kicker pulse duration is less 100 ns with rise(fall) time about 10 ns. That permits to observe deflected bunches only. The few bunches which are distorted in deflecting cavity by the rising or falling RF field don't hit the screens and are lost in the beam line. All other bunches are passing through the tomography module and accepted at the beam dump.

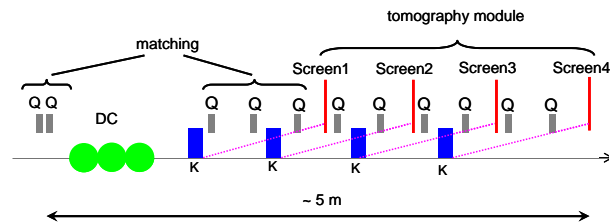

Figure 7. Prospect diagnostic for longitudinal slice emittance measurements. Q – quadruple; K – kicker; DC – deflecting cavity

The layout of diagnostics for longitudinal beam phase space measurements is shown in Fig.8. After tomography module downstream we plan to set dispersive section. The distance between the deflector and the screen in the dispersive arm is about 6 m. Bunches are deflected by a dipole magnet and are analysed on the screen. During the

dispersive arm operation the magnets in the tomography module will be off.

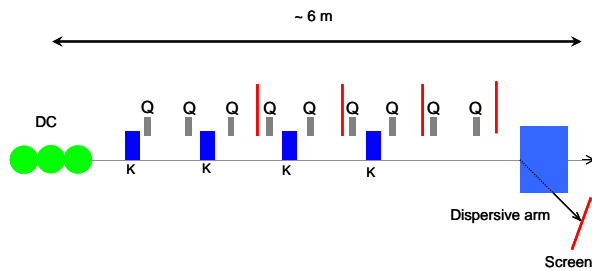

Figure 8. Prospect diagnostics for longitudinal beam phase space measurements.

## CONCLUSION

The deflectors reviewed in this paper satisfy the requirements for the beam diagnostic at PITZ2. We consider to use the travelling deflecting cavity due to its additional possibility to analyse single bunches in a bunch train. We expect the possibility to measure transverse slice emittance with  $\sim 20$  slices in the tomography module. For longitudinal phase space measurements in the dispersive arm we estimate the resolution as  $\sim 25$  keV/c.

The authors would like to thank D.J. Holder and B.D. Muratori for their work under the tomography module analysing.

## REFERENCES

- [1] F.Stephan, D.Kraemer, I.Will and A.Novokhatski, Proc. FEL2k, Durham, USA, August 2000
- [2] V.Miltchev et al., "Transverse Emittance Measurements at the Photo Injector Test Facility at DESY Zeuthen (PITZ)", DIPAC, 2003
- [3] D.Alesini, C.Vaccarezza, "Longitudinal and transverse phase space characterization", SPARC-RF-03/003, INFN/LNF, Frascati, 2003
- [4] V.Paramonov, et. al. "Effrctive standing-wave RF structure for charged-particle deflector", LINAC, 2006, (to be published)
- [5] O.H.Altenueller, et.al., "Investigations of traveling - wave separator s for the Stanford two-mile linear accelerator", The rev. of Sci. instr., Vol.35(4), 1964
- [6] D.J.Holder, et. al., "A phase space tomography diagnostic for PITZ", EPAC2006, Edinburgh, UK