

## COMMISSIONING OF C-ADS INJECTOR I\*

Jianshe Cao<sup>†</sup>, FangYan, Cai Meng, Huiping Geng, Rong Liu, Yanfeng Sui, Qiang Ye  
Institute of High Energy Physics, Beijing, China

### Abstract

As a test facility, the design goal of C-ADS Injector I is a 10mA, 10MeV CW proton linac, which uses a 3.2MeV normal conducting RFQ and superconducting single-spoke cavities for accelerating. The RF frequency of C-ADS Injector I accelerator is 325 MHz. In accordance to the progress of construction and considering the technical difficulties, the beam commissioning of C-ADS Injector I is carried out in several phases. This paper will summarize the beam commissioning in every phases and focusing on the final phase.

### INTRODUCTION

“The China Accelerator Driven Sub-critical System (C-ADS)” is one of the “Strategic Priority Research Program” of CAS. Its main task is to cope with nuclear waste material and produce clean nuclear power. It have two injectors, C-ADS injector I is a 10MeV proton linac with 10mA continuous current made by IHEP. It consists of an ECR (Electron Cyclotron Resonance) ion source, a LEBT (Low Energy Beam Transport), a 3MeV RFQ (Radio-frequency Quadrupole) with 325MHz frequency and a superconductivity linac accelerator with 3~10MeV [1]. The schematic diagram of C-ADS injector I is shown in Fig.1, and the specifications of the injector I are also listed in table 1.

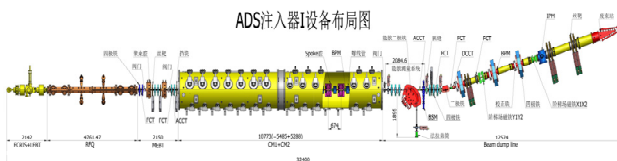

Figure 1: The Schematic diagram of C-ADS injector I.

Table 1: ADS Injector-I Test Facility Specifications

ADS Injector-I test facility specifications	
Particle	Proton
Output Energy (MeV)	10
Average Current (mA)	10
Beam power (kW)	100
Duty factor (%)	100
RF frequency (MHz)	325

### COMMISSIONING PHASE AND RESULTS

As shown in Figure 1, the Injector-I testing facility is composed of an ECR ion source, a LEBT, a RFQ, a MEFT, a superconducting (SC) section, an energy Analy-

sis Magnet (AM) and a beam dump line. The designed output energy of the RFQ is 3.2MeV. The SC section includes two cryomodules (CM1&CM2) with 14  $\beta=0.12$  SC spoke cavities, 14 solenoids and 14 cold BPMs, which is used to boost the proton beam energy up to 10 MeV [2]. At present, the commissioning of CM1 & CM2 with narrow pulse beam (duty cycle: 0.04 %, 2Hz/20us) is completed.

### LEBT, RFQ, MEFT Commissioning

The LEBT connect the ECR source to the RFQ and provides the matching between the ECR and RFQ. The ion source provides 35keV CW or pulsed proton beam with average current over 10mA [2]. The Figure 2 shows the LEBT layout. The total length of the LEBT is 1.67m. It includes 2 solenoid, 1 DCCT, 1 ACCT and a chopping system. The chopper can provide short or long pulsed beam. Beam width can be adjusted start from 40 ns with repetition frequency of 1Hz up to 50Hz. The rise and down time is smaller than 20ns.

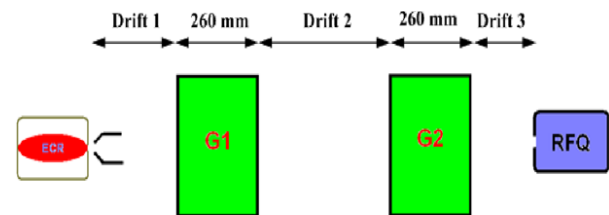

Figure 2: The layout of LEBT.

The emittance at the exit of the LEBT are measured by using Alison detector. The measurement result and the simulation result are shown in the Figure 3. The left on the Figure 3 is the simulated phase space 8.8cm downstream of the LEBT, and the right figure is the measured results. The both shape of the beam phase space looks very similar. Table 2 shows the designed twiss parameters and the measured results at the RFQ entrance. The twiss parameters are sensitive to the LEBT solenoid settings and we chose the one closet to the simulated parameters of the RFQ entrance in order to get matched beam [3].

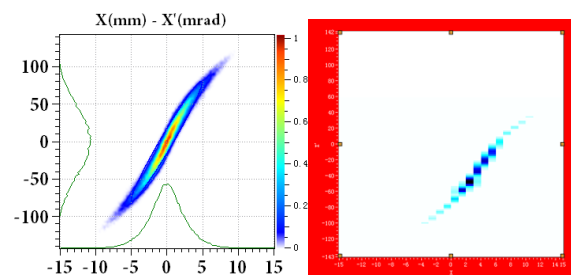

Figure 3: The simulation result (left) and the measurement result (right) of emittance at LEBT exit.

\*Work supported by CAS Strategic Priority Research Program-Future Advanced Nuclear Fission Energy (Accelerator-Driven Sub-critical System).

<sup>†</sup> caojs@ihep.ac.cn

Table 2: Beam Parameters at the LEBT Exit

Parameters	I (mA)	$\alpha$	$\beta$	E ( $\pi$ mm.mrad)
Design goal	10	2.41	0.0771	<0.20
Measurement	11.5	2.18	0.0774	0.14

The RFQ is composed of two resonantly coupled physical segments and each segment includes two technical modules connected together with flanges. Totally four couplers are mounted on the RFQ and two couplers on one physical segment. The output energy is 3.2MeV with the inter vane voltage of 55kV. The total accelerator length is 4.7m. The longitudinal normalized rms emittance is designed to be smaller than transverse emittance for better cavity efficiency [3].

The RFQ conditioning began on May 15th 2014. 71% duty factor was achieved in less than one month conditioning with short pulse, but stopped by vacuum leakage of the RFQ entrance plate, and the reason was the cooling water valve of the plate was closed by mistake. To prompt the conditioning process, an aluminum plate was installed instead of the original temporarily. Then 80% duty factor was achieved with short pulse after one week conditioning, but was interrupted again by the vacuum leakage of the RFQ coupling plate due to the welding it is not tight enough. On Aug. 21<sup>st</sup> 2014, the commissioning of 99.97% RF duty factor has reached. In the meanwhile CW conditioning was processed alternately. But on Sep. 27th, CW conditioning has to stopped for the MEBT&TCM installation according to the project schedule.

Though the beam duty factor is very close to CW, but it is really that the CW have not been reached. The reasons are as follows:

Early problems is lack of experience, such as the master oscillator can't be switched from pulse mode to CW mode directly, conditioning mode is inefficient (with pulse generator and switch gradually from pulsed to "CW"), as well as the coupler is damaged.

Later, the problems is that we have to catch up the project schedule. Once the CM2 commissioning with narrow pulse beam is completed, we will plan to restart the RFQ conditioning by CW mode and 3 mA beam commissioning.

The RFQ performance was checked by the beam with different duty factors. Over 95% transmission efficiency were achieved with the duty cycle greater than 90%, and the beam lasted over one hour stably, and then was stopped artificially for protecting the beam dump target [4]. The highest average beam power is greater than 31kW with output beam current of 11mA and 3.2MeV beam energy. The RFQ energy was measured with the time of flight method by using two FCTs downstream of the RFQ.

MEBT is composed of 6 Quadruples, 6 Steering magnets and 2 bunchers [5]. The beam based alignments were carried out for the MEBT BPMs, all the offsets of the BPM were less than 0.5mm. The beam center drift meas-

ured on all the BPMS are under the range of  $\pm 0.15$ mm with input cavity power of 280kW. Direct Root Mean Square formula was used in our case for the RMS beam size calculation to eliminate the calculate method error causing by the fitting formula [6].

The Table 3 shows the beam performance of twiss parameters and emittance comparison between the measurement and the simulations at the MEBT entrance.

Table 3: Beam Parameters at the MEBT Entrance

Parameters		$\alpha_x/\alpha_y$	$\beta_x/\beta_y$ (mm/mrad)	$E_{x/y}$ ( $\pi$ mm.mrad)
Simulation		-1.3/1.46	0.12/0.13	0.21/0.20
RFQ exit	Quad. scan	-1.8/0.72	0.17/0.09	0.16/0.21
	Double slits	-	0.46/1.85	0.14/0.14

Beam diagnostic devices located in the MEBT include 6 Beam Position Monitors, 2 Fast Current Transformers (FCT), one AC current transformer (ACCT) and 3 Wire Scanners. The two FCT are used for the energy measurement. The space between the two FCTs is 1.67m. Two downstream BPMs were used for the phase scanning to determine the buncher settings. Figure 4 shows the phase scanning results of two bunchers.

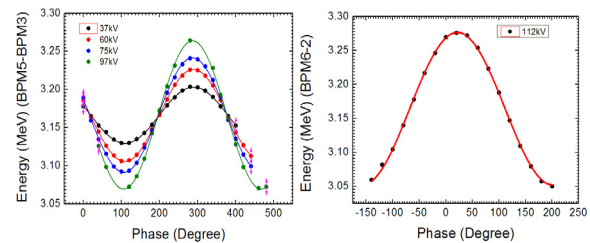

Figure 4: The phase scanning results of two bunchers, buncher 1 phase scan results V.S. different cavity voltage (left), buncher 2 (right).

### TCM Commissioning

The testing cryomodule (TCM) includes two  $\beta=0.12$  spoke cavities, two solenoids and two cold BPMs. The TCM is used to verify the performance of superconducting cavity, the cryogenic system, beam dynamic design, beam diagnostic system, superconducting solenoid and so on. The commissioning results of TCM is shown below:

- Beam duty factor: 1.5 %
- TCM transmission: 98%
- Output current: 10.1mA
- Gradient achieved:  $E_{acc}=3.1$ MV/m

The maximum cavity gradient can only achieve 3.1MV/m (the specification is 7MV/m), that is because of field emission caused by cavity contamination which preventing the accelerating gradient from increasing. The improved technologies and methods have been adopted for the succeeding cryomodules of CM1 and CM2.

### CM1 & CM2 Commissioning

The Figure 5 shows the schematic layout (on the top) of the injector I SC section and one period of accelerating (on the lower), respectively. Totally 14 periods are assembled in two cryomodules. The spacing between two cryomodules is 570mm. One standard period includes one  $\beta=0.12$  spoke cavity, one SC solenoid and one cold BPM. The designed accelerating gradient was 6.08MV/m on basis of the first prototype testing results.

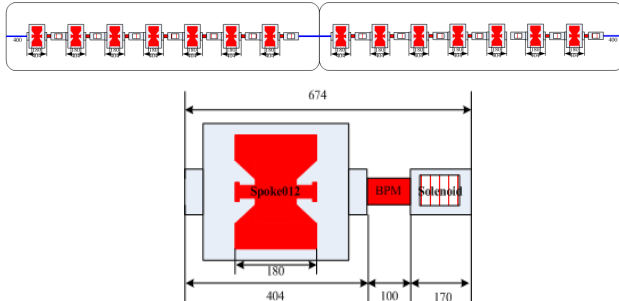

Figure 5: The SC section layout and periodical structure.

The CM1 was installed in the tunnel after the TCM commissioning and dismantled. The cavity phases are scanned 360 degree around to determine the designed sync and amplitude of all the cavities with two BPMs. The stably operating cavity gradient achieved was around 5.5MV/m during the CM1 commissioning. The output energy at the exit of CM1 reached 6.05MeV with 7 SC cavities, one cavity among them achieved accelerating gradient of 7.75MV/m, and the beam transmission for RFQ + CM1 and CM1 are 88.4% and 100%, respectively. The beam current of CM1 exit is 10.6mA. Figure 6 shows the emittance measurement results by two slits located at the exit of CM1.

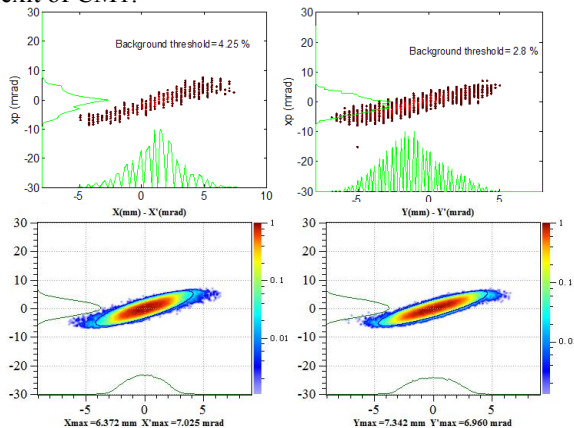

Figure 6: emittance measurement results (upper) by two slits at the exit of CM1 comparing with the simulation results (lower).

For the commissioning of CM2, it is similar with CM1. On June 17th, 2016, the injector I was successfully commissioned up to 10.1MeV at pulse beam current of 10.03mA with thirteen low-beta superconducting (SC) spoke cavities (#1 cavity is turn off). The energy was measured by using energy Analysis Magnet and two

BPMs with time of flight method, respectively. After two days later, the beam energy reached 10.25 MeV with fourteen cavities. Figure 7 shows the 10.03 mA peak current at the exit of the SC (CM1&CM2) section.

The issues during the commissioning of CM1&CM2 is that we have to warmup the SC two times for adjusting the SC frequency, and it is hard to keep running stably for a long time with multiple SC and cavities with high ACC simultaneously.

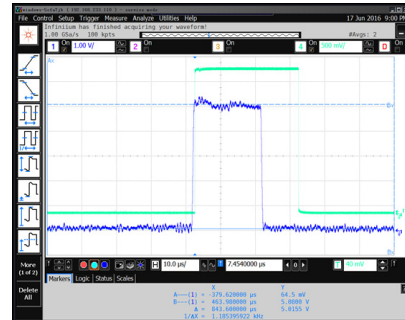

Figure 7: The peak current at the exit of the SC (CM1 & CM2) section is 10.03 mA.

### SUMMARY AND ACKNOWLEDGEMENT

The ion source+LEBT+RFQ+MEBT+CM1+CM2 were successfully commissioned with pulsed beam. Next we plan to do long pulsed beam or CW commissioning for injector I with low beam current. Also, the RFQ is still on the way to CW operation, new conditioning method will be tried later. More experiments is needed to be done to further understanding the beam performance. Investigation of the machine reliability and stability will be done in the future.

Sincere acknowledgement to the commissioning group of C-ADS Injector-I for the great efforts during the commissioning.

### REFERENCES

- [1] J.H. Yue, J. Hu et al., "Phase and energy measurement system for C-ADS injector I", Proceedings of IBIC2015, Melbourne, Australia.
- [2] Y. Yang, H. P. Geng et al., "Commissioning of the China-ADS injector-I testing facility", Proceedings of IPAC2016, Busan, Korea.
- [3] F. Yan, S. L. Pei et al., "Physics design of a 10MeV injector test stand for an accelerator-driven subcritical system, Phys. Rev. ST Accel. Beams 18, 054201 (2015).
- [4] Cai Meng et al., "Beam commissioning of C-ADS injector-I RFQ accelerator", proceedings of IPAC2015, USA, 2015.
- [5] H. Geng et al., "The MEBT Design for the China Accelerator Driven system", proceedings of IPAC2011, San Sebastian, Spain, 2011.
- [6] Y. Zhao, H. Geng et al., "Beam twiss measurement with WS including space charge effect", Proceedings of IPAC2016, Busan, Korea.