

HOW TO USE A SCADA FOR HIGH-LEVEL APPLICATION DEVELOPMENT ON A LARGE-SCALE BASIS IN A SCIENTIFIC ENVIRONMENT

Katy Saintin, Vincent Hardion, Majid Ounsy, Synchrotron SOLEIL, Saint-Aubin, France

Abstract

For high-level applications development, SOLEIL adopted GlobalSCREEN, a professional Java SCADA, developed by the ORDINAL Company [1]. This environment enables end-users to quickly build user-friendly GUIs without writing any java code and drag-dropping reusable graphical components developed for them by the software control team.

These components derive from the ATK [2] (Application Tango Toolkit) library, which provides a rich set of graphical widgets, including scientific data visualization tools, and already encapsulating communication with the Tango software bus.

SOLEIL thereby allows users to lay out their supervisory applications with a homogenous look and feel, and to benefit (since they are natively provided by GlobalSCREEN) from such functionalities as access right management, web access, and remote administration at minimal development cost. An original organization has been set up to deal with this collaborative work between “pure software developers” and “occasional” supervision applications developers.

The work organization, software architecture, and design of the whole system will be presented, as well as the current status of deployment at SOLEIL for accelerators and beamlines.

CONTEXT

The mission of the computer team in charge of Control and Data Acquisition at SOLEIL is to specify, design, and develop the data acquisition and control systems for the synchrotron and beamlines. Through the use of generic tools, software, and materials, they ensure the coherence of the system as a whole. Thus, they define and implement the standards which today constitute the backbone of the control system.

The TANGO control system framework [3] was selected for this huge undertaking. Conceptually, it may be considered a software bus enabling heterogeneous applications in terms of platform and languages to communicate in a shared environment. The object technologies on which it is based allow TANGO to fulfil quality requirements, in terms of robustness, evolutivity, and maintenance.

This framework is provided with various ready-to-use tools. One of our tasks is to develop the supervision applications.

User Requirements

Source and beam line users need a great number of supervision applications for communicating with the

TANGO control system at SOLEIL. These users must be sufficiently autonomous to act when there is a problem, and to themselves figure out how its applications work.

Constraints

Several constraints justify our approach:

- Our computer team has limited resources. There are only five persons (partially) assigned to GUI development.
- Users have a large number of applications: fourteen applications for the source and 24 for the beam lines (each beam line has one application).
- Applications continually evolve.
- Our users are not computer programmers.

Our Vision

For reasons stated above, we sought a solution that permits the following features:

- Users must be able to bring their own applications.
- A shared library of reusable components must be available.
- Applications must be homogeneous in their look and feel, as well as in their utilization.

OUR SOLUTION

GlobalSCREEN

GlobalSCREEN is a SCADA supporting the JavaBeans technology. Java beans are reusable graphical unitary components often used in java GUI software projects (Swing components). GlobalSCREEN provides a user-friendly GUI to carry out Java applications by drag-dropping. It also proposes to integrate the entire developed reusable components in a shared library.

This approach therefore provides the anticipated user autonomy and satisfies the constraints specified. Furthermore, it allows integration of all Java developments (complex applications and beans) already provided in the Tango framework.

The homogeneity and coherence of applications are ensured by the ATK and Tango Framework.

ATK and Tango Framework

Our control system, Tango, is provided with ATK, a Java library of beans communicating with this control system (e.g., a button executing a Tango command, or a numerical field reading a Tango value). These beans manage their own logic and the Tango specifications (color code, look and feel of the widget). Several complex

Java applications use this library. We therefore benefit from all the developments, thus reducing additional development effort.

Therefore, the main goal for us was to adapt all the ATK widgets in a specified GlobalSCREEN library that we called the SoleilLibrary (see Fig. 1).

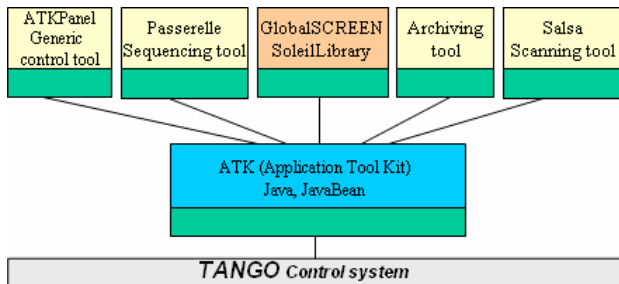

Figure 1: Our GlobalSCREEN solution was derived from ATK provided by Tango framework.

Our Organization (see Fig. 2)

- Our computer team adapts ATK components in a GlobalSCREEN library called the SoleilLibrary. We provide and maintain documentation on the SoleilLibrary.
- Advanced users, who are familiar with GlobalSCREEN, build a library of specific components and carry out their applications starting from the SoleilLibrary. They provide documentation for and maintain their own applications.
- Final users write specifications for high-level applications, then test and use the applications.

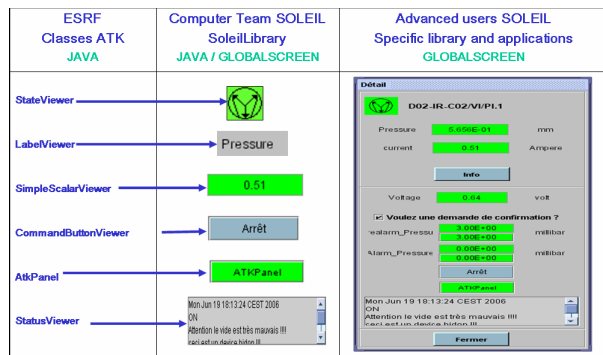

Figure 2: Our organization.

STATUS @ SOLEIL

The supervision applications of the first 11 beam lines are now ready for commissioning. The 3 advanced users of the source have already implemented 14 different applications.

These applications are derived from their specific library, which contains about 140 reusable components. Their library also provides a unique layer, which is displayed in each application, so all of them have the same look and feel.

Table 1: Status @ SOLEIL.

Team	No. persons	No. components	No. applications
ESRF: Computer team	2	ATK 103 classes	0
SOLEIL: Computer team	2	SOLEIL Library 97 components	0
SOLEIL: Beam line team	8	Beam line Library 33 components	11
SOLEIL: Synchrotron team	3	170 components	14

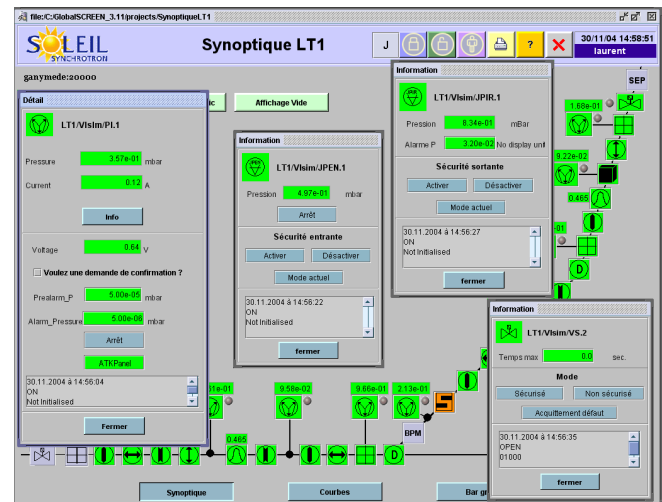

Figure 3: Vacuum synoptic of TL1 transfer line GlobalSCREEN application.

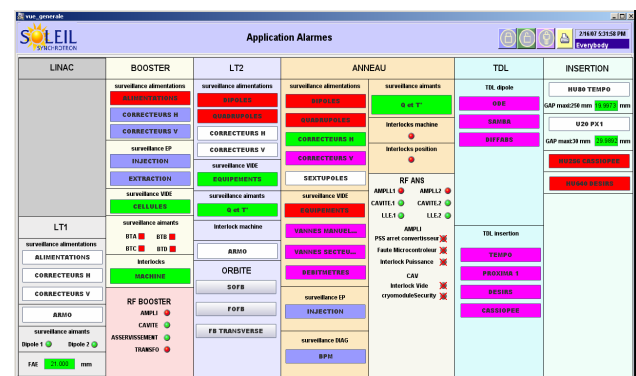

Figure 4: GlobalSCREEN Application for the alarms supervision.

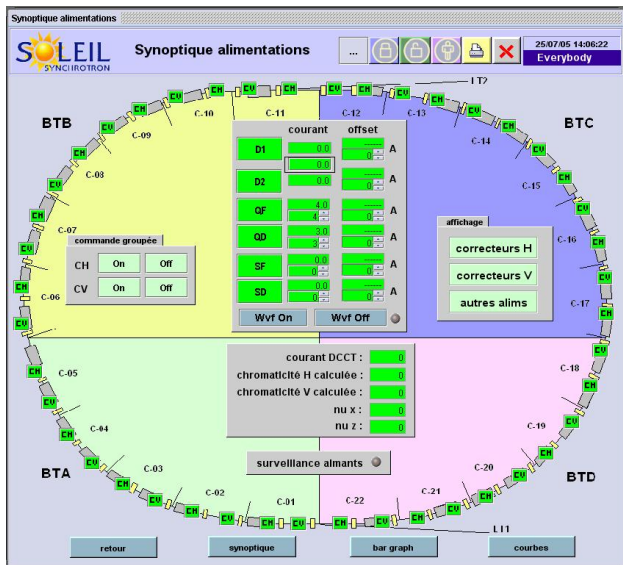

Figure 5: Power supply synoptic of BOOSTER GlobalSCREEN application.

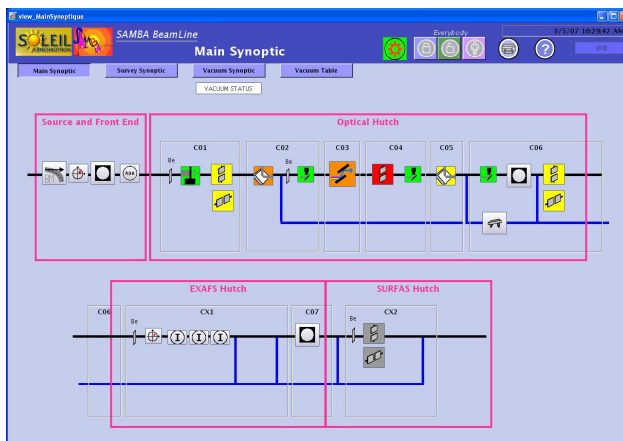

Figure 6: Main synoptic of Samba beam line.

FUTURE

JDraw Integration

A Java vectorial tool developed by ESRF [4] allows creating a synoptic by dragging and dropping components that communicate with Tango. This tool uses also the ATK library (see Fig. 7).

This tool will be added to GlobalSCREEN.

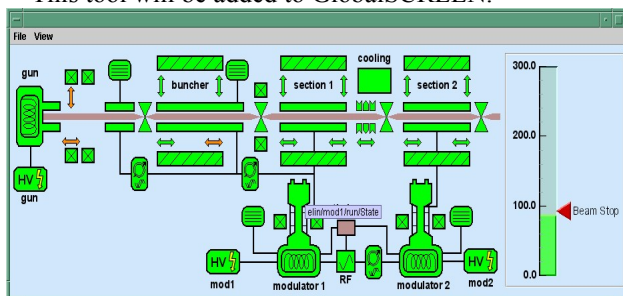

Figure 7: JDraw a synoptic editor.

Services Integration

Certain services have been developed in SOLEIL, such as an archiving system [5]. It is also developed in Java, and uses the ATK library. GlobalSCREEN will provide a service that articulates with this existing archiving service.

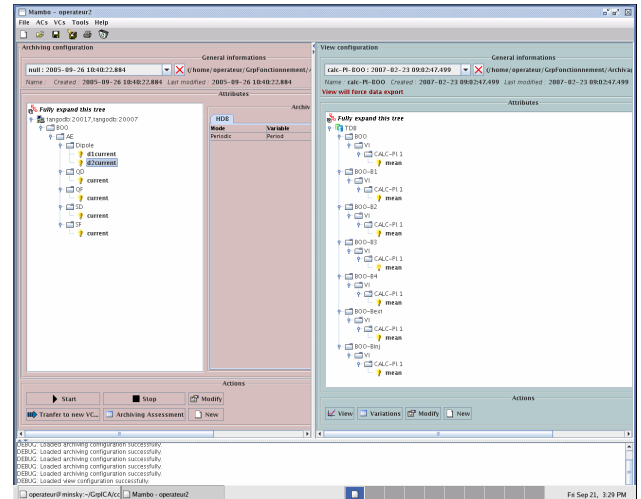

Figure 8: Archiving tool.

Java Tool Integration

The main long-term goal is to integrate each new Java tool, as it is done with ATK, ATKPanel (generic control tool see Fig. 1), and Salsa (Scanning tool, see Fig. 1) in GlobalSCREEN.

REFERENCES

- [1] <http://www.ordinal.fr/>
- [2] ATK: Application Tool Kit
- [3] This proceeding “Status of the SOLEIL control system” by Nicolas Leclercq.
- [4] European Synchrotron Radiation Facility <http://www.esrf.eu/>
- [5] This proceeding “Status of the Tango archiving system” by Sandra Pierre-Joseph Zéphir.