

MEASURING OF BETATRON COLLIMATED BREMSSTRAHLUNG PROFILE*

A.V. Vukolov, A.I. Novokshonov, A.P. Potylitsyn, E.N. Shuvalov, V.I. Bepalov, D.A. Shkitov
Tomsk Polytechnic University, Tomsk, Russia

Abstract

Bremsstrahlung beams of a betatron with energy lower than 10 MeV are successfully used in X-ray and γ -ray introspection for recognition of groups of materials according to their atomic number [1], for a digital diagnostics in medicine [2] and etc. In this case it is necessary to collimate the beam to obtain required size of a field on an object. Divergence of bremsstrahlung beam is determined by the electrons energy and the thickness of target. It can reach values about $\langle \theta_\gamma \rangle \sim 30^\circ$ for the electrons energy ~ 5 MeV. On the distance $L \sim 500$ mm between a radiator and an irradiated object the size of a beam must not exceed $S \sim 0.1L$. This requirement is in order to prevent any distortions of defect image because of the beam divergence. In this article dependence of a "pattern" size on the distance L at a fixed size of a collimator located right on the betatron is investigated.

EXPERIMENTAL SETUP

In our work the betatron with fixed energy of electron beam $E_e = 3.5$ MeV, 200 Hz frequency and $50 \mu\text{s}$ duration of pulses was used. Thickness of a tungsten target was chosen as 0.6 mm. An intensity of its bremsstrahlung on 1 m distance was $I = 1.2$ mGr/min.

The spectral distributions of bremsstrahlung intensity for our conditions are presented in Fig. 1 (these distributions were calculated in PCLab [3]). Upper curve shows simulation results for angular acceptance $\theta_{max} = 25^\circ$, lower curve - for $\theta_{max} = 6^\circ$. One can see significant contribution of photons with energy 0.511 MeV from annihilation of secondary positrons, which were produced in the target. In order to reject contribution from "soft" bremsstrahlung photons including annihilation quanta we used a Cherenkov detector to investigate a shape of collimated γ -beam.

As the detector a Cherenkov radiator made from acrylic plastic ($n = 1.49$) was used which is non-sensitive to low energy bremsstrahlung component of a betatron beam. Minimal energy of electrons generating Cherenkov radiation in our radiator is $E_{e \min} \approx 690$ keV. The size of the radiator was $1 \times 20 \times 150$ mm and it was connected to the silicon PMT Sensl B [4]. Its main parameters presented in Table 1:

There were made separate measurements for determination of the betatron bremsstrahlung field distribution. In Fig. 2 the schematic of the betatron bremsstrahlung angular distribution measurement is shown. The detector was mounted on a rod on the distances $L_i = 500 \div 800$ mm. The mechanism of the rod rotation was mounted right above

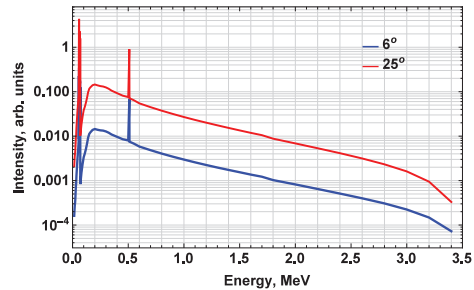

Figure 1: Spectral distributions of the bremsstrahlung: blue curve - in cone with angle 6° ; red curve - in cone with angle 25°

Table 1: Silicon PMT parameters

Parameters	Value
Active area	$6 \times 6 \text{ mm}^2$
Spectral range	from 300 nm to 800 nm
Photon registration efficiency	up to 47 % with 420 nm wavelength
Gain coefficient	10^6

the point generating bremsstrahlung (injector), it allows to measure angular distribution of the bremsstrahlung.

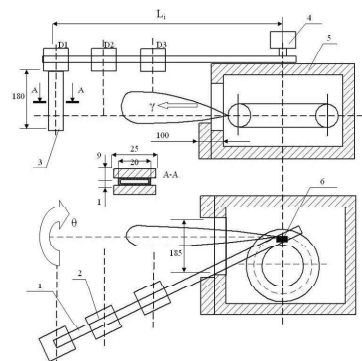

Figure 2: Schematic of the betatron bremsstrahlung angular distribution measurement. 1 - rod; 2 - silicon PMT; 3 - plates of acrylic plastic and lead; 4 - rod rotation mechanism; 5 - lead protection; 6 - injector.

In Fig. 3 a typical angular distribution measured on the distance 800 mm using the Cherenkov detector is shown. The average angle of multiple scattering of electrons with 3.5 MeV energy in the betatron target is 68.5° but the characteristic bremsstrahlung radiation angle is $\gamma^{-1} = 8.4^\circ$.

* This work was supported by the Russian Federation Ministry of Science and Education within the program "Nauka" Grant # 3.709.2014/K.

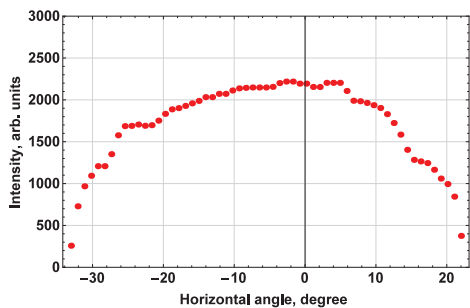

Figure 3: Angular distribution of the bremsstrahlung beam measured using the Cherenkov detector

The angular distribution of the bremsstrahlung field measured on different distances from the target is shown in Fig. 4

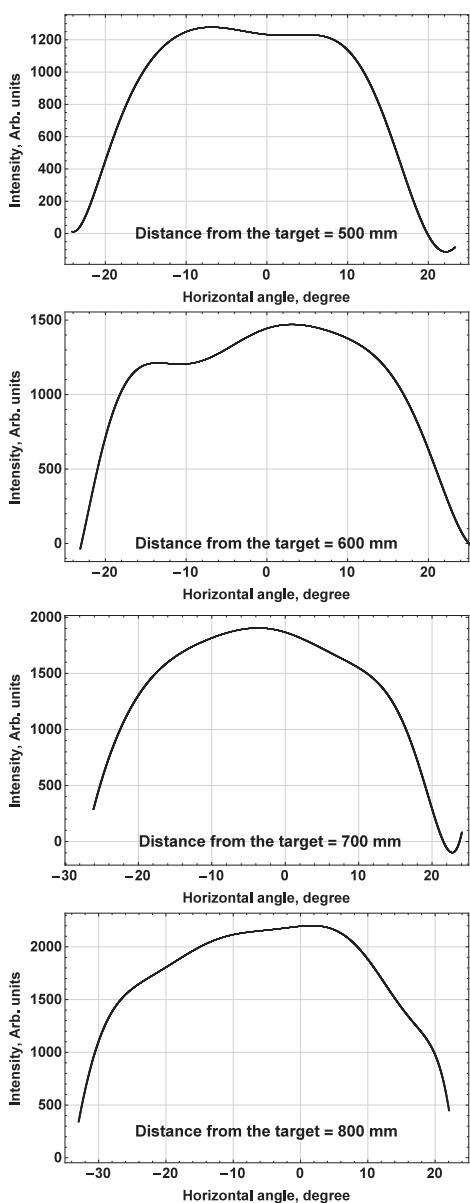

Figure 4: Angular distribution of the radiation field measured on different distances from the target

For measurement of collimated beam profile a similar mechanism was used (see Fig. 5). The detector was inclined at the angle 35° to its movement plane, this angle corresponds to the maximal yield of Cherenkov radiation. The lead collimator was located at the distance 300 mm from the target. Its thickness and width were 100 mm and 20 mm respectively.

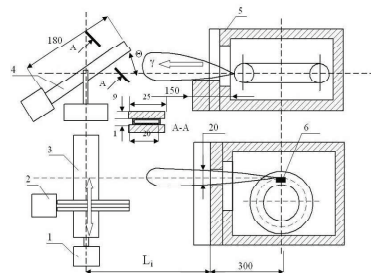

Figure 5: Schematic of collimated beam profile measurements. 1 - motor; 2 - silicon PMT; 3 - movement mechanism; 4 - plates of acrylic plastic and lead; 5 - lead protection; 6 - injector.

In Fig. 6 a profile of collimated beam measured on the distance $L = 200$ mm from the collimator is shown.

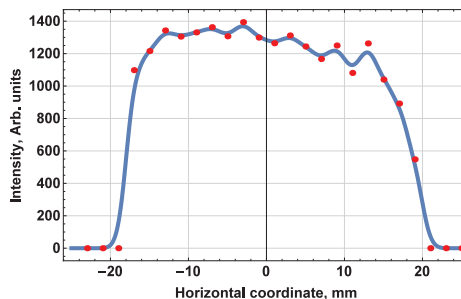

Figure 6: Profile of collimated beam on the distance 200 mm

The measurements carried out on different distances L_i allowed to get the dependence $H = 70 - 47 \exp(-L_i/L_0)$, where $L_0 = 300$ mm is a distance between the injector and the external side of collimator. The dependence is shown in Fig. 7.

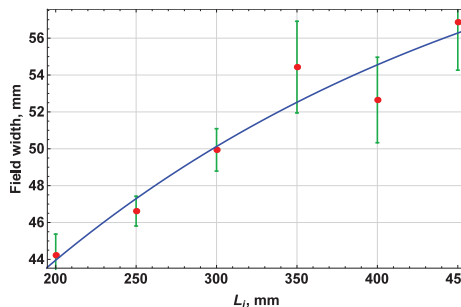

Figure 7: Field width on a distance dependence

For comparing of the results a cylindrical BGO scintillator was used. Its radius and height were equal to 10 mm. The

schematic of the BGO scintillator movement was the same as shown in Fig. 5. In Fig. 8 the comparison of collimated bremsstrahlung field width on a distance dependencies is shown.

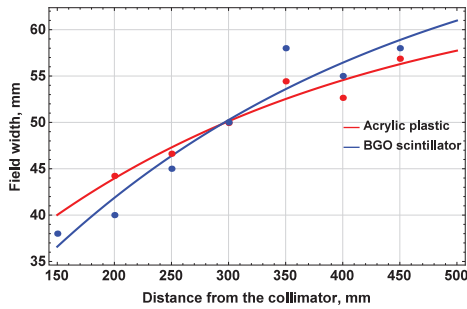

Figure 8: Comparison of a field width on a distance dependencies

In conclusion it should be mentioned that the proposed technique allows to register high energy component of beta-

tron bremsstrahlung, which could be used for γ -introspect of thick products, and it is non-sensitive to low energy component of bremsstrahlung which leads to high background level in case of using of standard technique based on ionization chambers.

REFERENCES

- [1] S. A. Ogorodnikov, V. I. Petrunin, M. F. Vorogushin, in *Proc. EPAC 2000*, pp. 2583–2585.
- [2] A. R. Wagner, A. P. Potylitsyn, V. V. Kashkovskiy, Y. N. Adishev in *Proc. RuPAC'06*, pp. 369–371.
- [3] *PCLab manual*, http://portal.tpu.ru:7777/SHARED/b/BVI/pclab/Tab/PCLAB_instr.pdf
- [4] *Silicon PMT manual*, <http://sens1.com/downloads/ds/DS-MicroJseries.pdf>