

PAL-XFEL DIPOLE MAGNET POWER SUPPLIES*

Seong Hun Jeong[#], Ki-Hyeon Park, Hyung Suck Suh, Sang-Bong Lee, Bongi Oh, Young-Gyu Jung, Hong-Gi Lee, Dong Eon Kim, Heung-Sik Kang and In Soo Ko
 PAL, Pohang, Republic of Korea

Abstract

Total 632 magnet power supplies (MPSs) are under operating in PAL-XFEL. These magnet power supplies can be categorized as three types - corrector, quadrupole and dipole. The dipole MPSs are ranging from 110A/80V bipolar PS to 310A/200V unipolar PS. The long term stability of bipolar power supply is 10 ppm with 250 A 40V output for gun solenoid. The three types of dipole MPSs are developed for PAL-XFEL. Precise measurement results show that all power supplies meet the required specifications. The long term operation stability of the MPSs are appeared to be sufficient for a stable operation of the PAL-XFEL.

INTRODUCTION

The PAL-XFEL requires low beam-emittance (< 1 μm·rad), ultrashort bunch length (~ 50 fs), high peak current (~ 4 kA), high stability of beam energy (< 0.01%), and measurement and steering of beam trajectory within micrometers (< 2 μm) [1]. Therefore, PAL-XFEL needs high stable and high precision magnet power supplies (MPSs) for beam orbit control. The PAL-XFEL have five kinds of power supplies for seven kinds dipole and eleven kinds quadrupole magnets. Table 1 shows the specifications of the power supplies needed for the PAL-XFEL dipole and quadrupole magnet. The total number of MPS for those magnets is 276.

The MPSs for the dipole were categorized into two types, unipolar and bipolar. And it was grouped to three types according to its current and voltage ratings. All MPS testing started in December 2015 and will be finished by end of May 2016.

Table 1: Dipole & Quadrupole MPS Specifications

MPS Type	I [A]	V[V]	Qty[ea]	Stability[ppm]
A-1	20	20	180	50 & 100
A-4	±20	20	38	50 & 100
B-1	190	110	31	10 & 50 & 100
B-2	310	85	5	10 & 50
B-3	310	200	2	50

BASIC STRUCTURE

Fig. 1 shows the general hardware configuration of the MPS. The topology of the power convertor was either buck for unipolar and H-bridge for bipolar. The input stage consisted of 12-phase transformer, full rectifier and a damped low pass filter. The transformers have two secondary windings, one delta-connected and the other wye-connected to produce the necessary phase shift for the 12 pulse or 720 Hz ripple in the output. At least two 6-pulse

bridge rectifier assemblies are used. The bandwidth of the input filter should be less than 30 Hz to have a good output performance. The output stage was composed of a low pass filter to reduce the switching noise. The output filter composed of two stage LC filters where the pole of the first stage was about ~KHz and second one was between higher than one-half and full of the switching frequency [2].

The DSP TMS320F28335 from TI Co was used to control the duty of the PWM and to interface surrounding peripherals. The normal PWM is about ~13.5 bit, But it has six enhanced PWM modules with 180 ps micro edge positioning (MEP) technology [3]. Thus effective PWM resolutions can be increased up to about 19-bit in case of switching frequency of 12.5 KHz. It can offer the sufficient resolution for the high stability.

The power supply performs the Ethernet communication by the uc5282. And it has RS232C on the front panel to monitor the MPS status at the site.

All MPS are equipped with latched interlocks to detect both MPS and magnet abnormal conditions, such as: input voltage out of the range, transformer input current unbalance, internal over-temperature, ground fault, and magnet over-temperature or cooling-water flow loss [4].

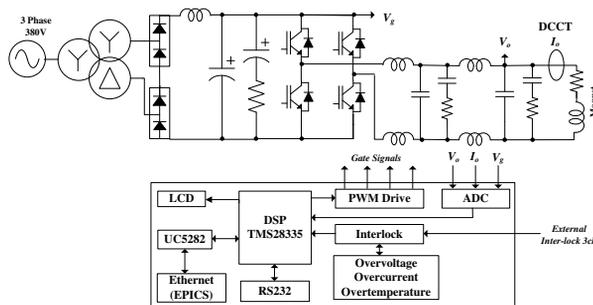

Figure 1: Block diagram of the Dipole and Quadrupole magnet power supply.

CONTROL STRATEGY

The control loop for the developed MPS is given in Fig. 2. It contained a feed-forward loop for the input link voltage, Vg. These compensators were applied a proportional-integral (PI) type which was very common in feedback systems. The current loop control bandwidth has a 6 KHz which is sufficient to correct the slow magnet resistance variations due to temperature changes [5].

For the diagram in Fig. 2, the output current is given by

$$I_{out}(s) = I_{ref} \frac{G_c(s)G_p(s)}{1+T(s)} + v_g \frac{G_{vg}(s)G_p(s)}{1+T(s)} \tag{1}$$

where loop gain $T(s) \equiv G_c(s)G_p(s)H(s)$ and $H(s)$ is the gain of the DC current transducer (DCCT). v_g is the link voltage.

*Work supported by Ministry of Science, ICT & Future Planning
[#]jsh@postech.ac.kr

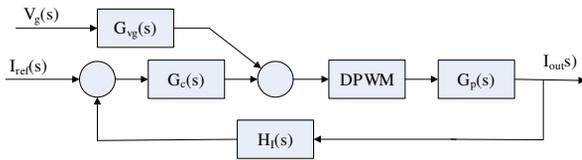

Figure 2: Block diagram of complete current loop system.

PERFORMANCE OF POWER SUPPLY

A local company manufactured 276 MPSs of quadrupole and dipole. Total 73-unit racks had installed and started commissioning. Figure 3 shows the installed power supplies at the gallery. Each rack has volt meters for input AC line voltage and temperature. The rack has isolation transformer for control power that applied for all MPS.

These MPSs have a character LCD for display the basic information of MPS like set current, load current and output voltage, etc. LEDs also showed the operation status, communication status, interlock status, etc.



Figure 3: Dipole and quadrupole power supply at site.

During the commissioning, the stability is kept testing based on HP3458A digital voltmeter from Agilent Co. with an external DCCT STH 600 from Danfysik. The major specifications of MPS were examined for short term stability, long term stability, zero cross response, reproducibility and line regulation.

We found that each MPSs were not fully isolated in the coupling issues between trim coil and dipole magnet main coil because two coils wound into a same magnetic core.

Figure 4 shows the Control System Studio(CSS) window for MPS. Each MPS has the independent window for control. The left window is a operation window and right one is a window for MPS parameters setting. The MPSs were controlled easily by the CSS window.

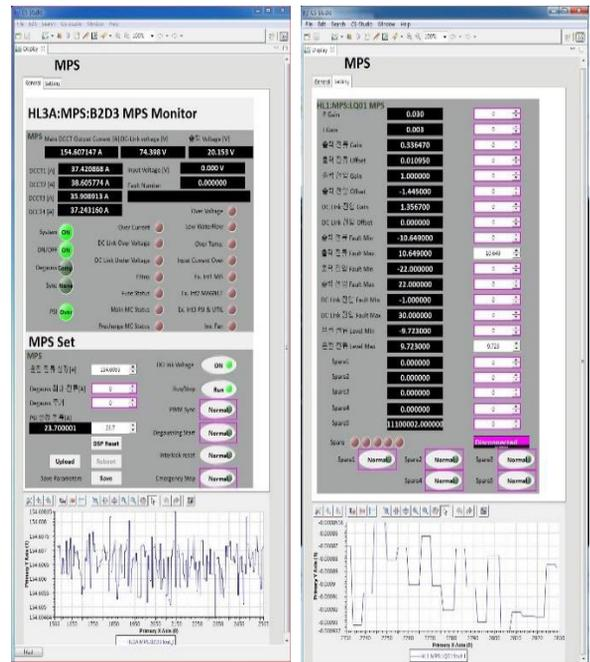

Figure 4: CSS window for Dipole MPS local control.

Figure 5 shows the short term current stability of the B-1 type MPS. The current stability with the load was about less than 10 ppm of 250 A output current.

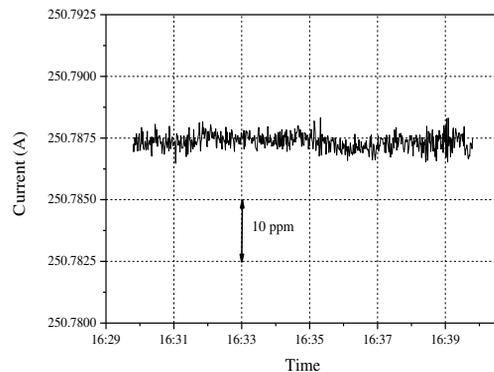

Figure 5: short term stability of B-1 type MPS.

Figure 6 shows the zero cross response of the B-1 type MPS.

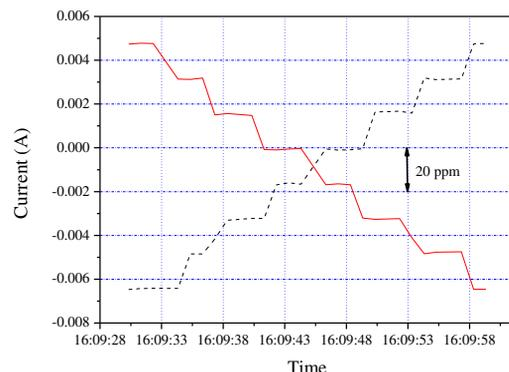

Figure 6: Zero cross response of the B-1 type MPS.

When 20 ppm step of the input current was increased from -0.006 A to 0.005 A, the MPS showed good output responses.

Figure 7 shows the reproducibility response of the B-1 type MPS. The output current is changed from 25 A to 250 A for 1-minute interval. It shows the less than 5 ppm accuracy response.

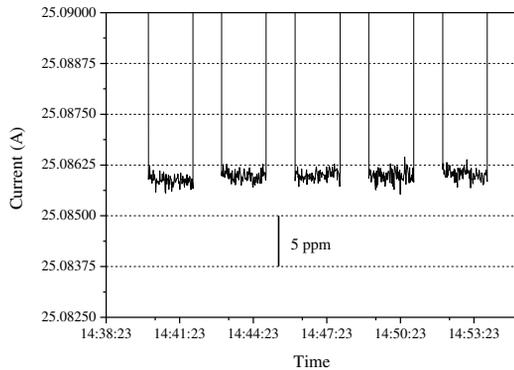

Figure 7: Reproducibility response at 25 A.

Figure 8 shows the AC line regulation. The AC line was changed intentionally the $\pm 10\%$, but output current stability was not effected so much.

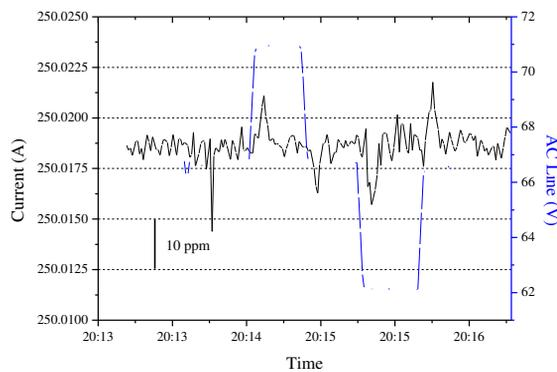

Figure 8: Line Regulation.

Figure 9 shows the output ripple voltage at 250 A output current. It is about less than 200 mV. Figure 10 demonstrates stability test results of 52 hours when the output current is 180 A of the B-1 type MPS. It is about less than 30 ppm at 180 A output which result satisfies the required specification.

Total 171 MPSs were installed for dipole and quadrupole and proceeding the commissioning for PAL-XFEL hard x-ray line. In early stage, there were some minor faults occurred like communication or personal safety interlock.

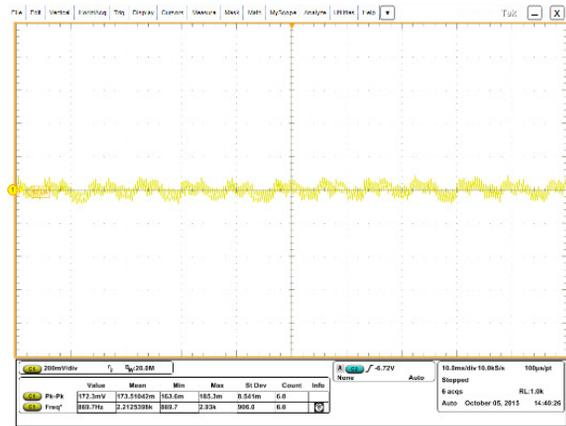

Figure 9: Output ripple voltage.

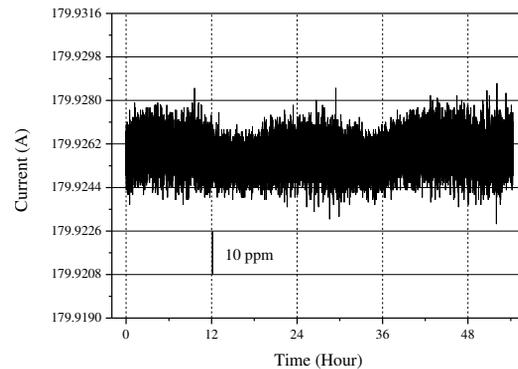

Figure 10: Long term stability for 52 hours of the B-1 Type MPS.

CONCLUSION

This paper described the Quadrupole and Dipole MPS requirements, control scheme, MPS site test results for PAL-XFEL. The experimental results with the installed MPSs showed the high stability. The short term stability is about 10 ppm and long term stability for 6 hours is about 20 ppm, respectively. These MPSs included the small web server to make easy maintenance. Total 632 MPSs were in commissioning mode now.

REFERENCES

- [1] Changbum Kim, et al, "Beam diagnostic system for PAL-XFEL", THPD28, FEL2012, Japan, August 2012.
- [2] K. H. Park, et al., "The magnet power supply for PAL-XFEL", MOPME058, IPAC2014, Germany, June 2014.
- [3] Texas Instruments Co., www.ti.com
- [4] P. Bellomo, M. Berndt, A. de Lira, G. Leyh, J.J. Lipari, "Spears 3 DC magnet power supplies – An Overview" APAC 2004, Korea, March 2004.
- [5] K. H. Park, et al., "Implementation of high precision magnet power supply using the DSP", THPMA024, APAC2007, India, January 2007.