

SOLID TARGETRY FOR THE ISOTOPE PRODUCTION FACILITY AT THE KOMAC 100 MeV LINAC

Sang-Pil Yun[†], Hyeok-Jung Kwon, Han-sung Kim, Yong-sub Cho, Kyung-Tae Seol,
Young-Gi Song, Dae-Il Kim
KOMAC / KAERI, Gyeongju, Korea

Abstract

The construction of the isotope production facility was recently completed on the 100 MeV proton linac at the KOMAC (Korea Multi-purpose Accelerator Complex). To produce the Sr-82 and Cu-67, we have prepared the solid targetry which consist of target transportation system, target cooling system and a hot-cell for remote handling. The Isotope production targets are made of RbCl pellet, Zn metal disc and stainless steel cladding. For the proton beam irradiation, the targets are transported by target drive system which consist of drive chain and guide rail by remotely. In this paper, we will report the detailed design, fabrication and operation status of the solid targetry at the KOMAC isotope production facility.

TARGET PREPARATION

To design RI target, we have derived the optimum thickness of target materials considering the beam energy loss by the beam window, cooling water and target claddings through SRIM calculation [2]. Figure 1 describes the typical target configuration for Sr-82 production, which is consisted of 1 RbCl target and aluminum dummy target.

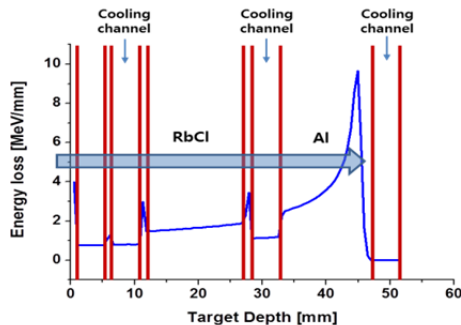
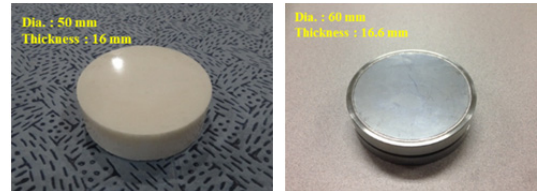
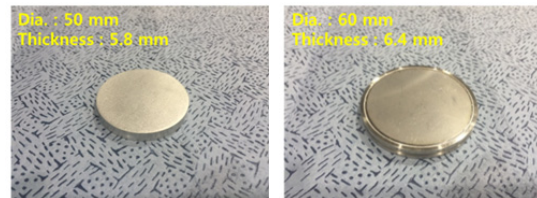

Figure 1: Target configuration for Sr-82 production.

For the Sr-82 and Cu-67, the pressed RbCl pellet and Zn metal disc was prepared. These target materials have the natural abundance of isotopes and they are encapsulated in stainless steel cladding with o.d. of 60 mm and i.d. of 50 mm with 0.3 mm window for the proton irradiation. To prevent the leakage of the radioactive species inside target claddings, the cladding is fabricated by laser welding. After the target cladding fabrication, the leakage tests have been conducted by using the penetration test. Figure 2 shows the fabricated proto-type target claddings after welding process.



(a) RbCl pellet and its target cladding



(b) Zn disc and its target cladding

Figure 2: The proto-type target for Sr-82 / Cu-67 production.

SOLID TARGETRY

Target Holder Design and Fabrication

The RI targets are mounted inside the target holder for their supporting and cooling. The cooling water is incoming from the bottom side of target holder and flow out through the upper side. Inside of target holder, there are the three cooling channels between two targets for the efficient target cooling. For the cooling water coupling, 3 nozzles of target holder plug into the cooling manifold at the target irradiation position. These coupling nozzles are 26.5 degree slanted for simple coupling. This target holder can be inserted into the target transport system and withdrawn by remote handling inside the hot-cell. Figure 3 describes the prepared target holder.

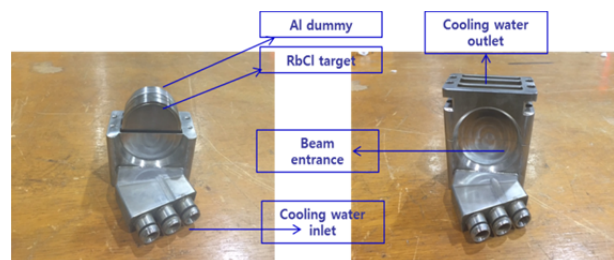

Figure 3: The fabrication of target holder.

Target Transport System

For the transportation of target carrier from the hot-cell to the target irradiation chamber, target carrier is driven by the electric AC servo motor with chain and sprocket system thorough the target transport pipe. The oscillations of target carrier during its motion are controlled by con-

straining by two guide rail which attached inside of transport pipe which is filled by deionized water for the prompt neutron shielding during the beam irradiation. Therefore, All parts and structural materials are made of the stainless steel to prevent the corrosion of the target transport equipment. Figure 4 describes these target transport mechanism and the cooling water coupling in the target transport system.

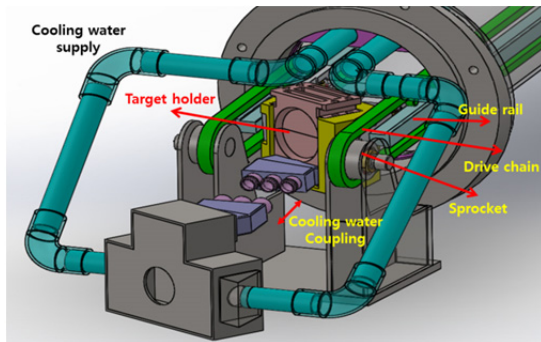

Figure 4: Scheme of target transport.

To minimize the occurrence of the faulty condition in the high radiation environment, the rubber or elastomer seals are totally excluded from the piping joint by using the metal seal and flange. For the easy maintenance, the target driving components which are AC servo motor, position sensor, level sensor and so on, can be replaced by remote handling in the hot-cell. These target transport system was installed after 18,000 times of mock-up test. Figures 5 and 6 show inside of the target irradiation chamber and the target transport system in the hot cell facility.

A hot-cell consist of the two designated cells, the one cell provides personnel shielding during the target inserting or withdrawing process. Another cell was constructed for target handling and transport process to the chemical processing hot-cell. A hot-cell is containing 15 cm of lead wall with 376 mm thick lead glass windows and two sets of master slave manipulators.

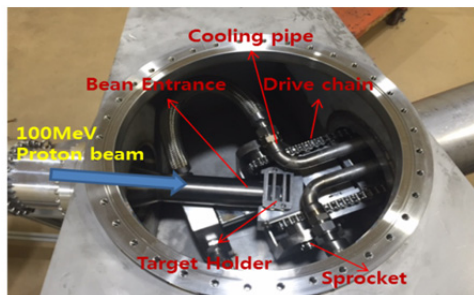

Figure 5: Inside of target irradiation chamber.

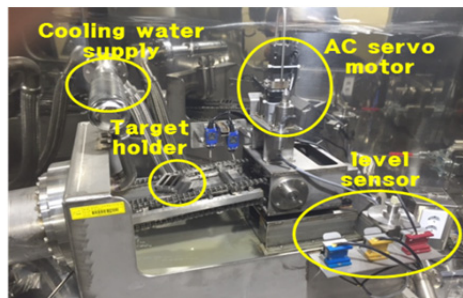

Figure 6: Target transport system.

Target Cooling System

The 100-MeV proton have the maximum 30 kW power, For the removal of 30 kW heat load, we have prepared independent cooling system. The typical flow rates of coolant are 180 L/min, the cooling water flows past the target paces in the 3 cooling channels between targets (typical flow rate: 60 L/min per the each cooling channel). The coolant was selected the de-ionized water to prevent the corrosion inside target transport system. The cooling system consists of air-cooled chiller, water purification filter and de-ionized water product apparatus and all components are integrated at a SKID (Fig. 7). The radioactivity monitor and the conductivity meter were attached at the cooling system for radioactivity monitoring. To shield the gamma from the radio-activated cooling water, 5 cm-thick lead shielding was prepared. (Fig. 8) The target cooling systems can be remotely monitored and controlled by EPICS IOC.

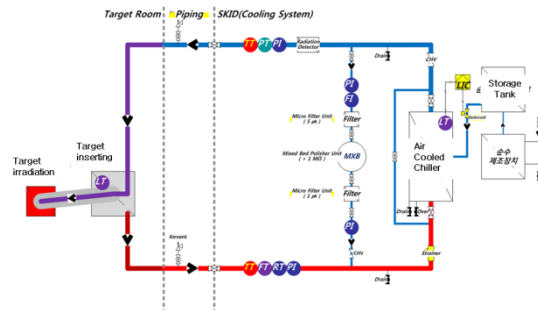

Figure 7: Schematics of the target cooling system.

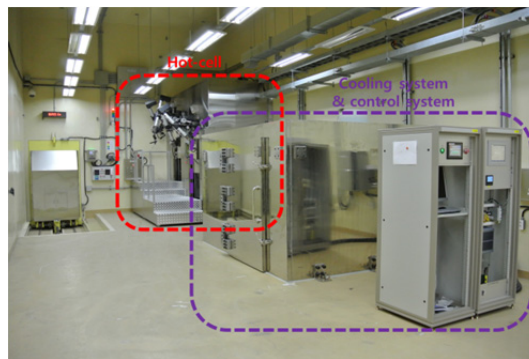

Figure 8: Installation of the target cooling system.

PRELIMINARY IRRADIATION TEST

For the beam commissioning of the new RI production targetry system and the preliminary irradiation of proto-type target, the low flux of proton beam irradiation test was conducted. Table 1 describes the irradiation test conditions.

Table 1: Irradiation Test Conditions

Peak current	0.2 mA
Pulse width	100 usec
repetition	1 Hz
Flux density	7.4E+6 #/cm ² -pulse
Irradiation dose	2.5E+10 protons

For the identification of Sr-82 and Cu-67 production, we have measured the characterized gamma emission spectrum from the irradiated RbCl and Zn target by using the HPGe(High Purity Germanium) gamma spectroscopy system after proton beam irradiation. For the detection, the target claddings didn't separate from target material due to the absence of isotope separation and purification facility. The experimental set-up and the decay characteristics of Sr-82 and Rb-82 were described by Figure 9 and Table 2.

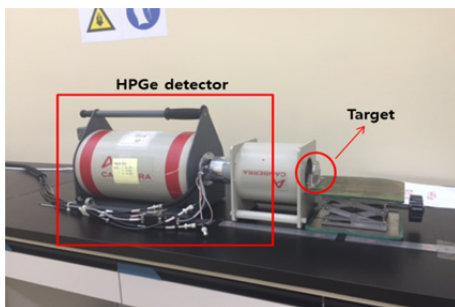

Figure 9: Experimental set-up for gamma spectroscopy.

Table 2: Decay Data of Sr-82 and Cu-67

	Sr-82	Cu-67
Decay mode	Electron capture	Beta (-)
Half life	25.5 day	2.58 day
Daughter	Rb-82	Zn-67 (stable)
Main gamma	From Rb-82 - 511 keV (192%) (positron annihil.) - 776.5 keV (13%)	- 91 keV (7%) - 93.3 keV (16%) - 184.6 keV (48.7%)

Figures 10 and 11 show the measured gamma spectrum from the irradiated RbCl and Zn targets. Through the HPGe gamma spectroscopy, because we didn't separate the target from the claddings, the unwanted gamma peaks emitted from the cladding material were measured. Among them, we could obtain 511 keV and 776.5 keV gamma emissions, which is the typical gamma spectrum from Sr-82/Rb-82.

And also, we could obtain 91 keV, 93.3 keV, 184.6 keV gamma emissions, which is the typical gamma spectrum from Cu-67. These measured gamma spectrum shows the production of Sr-82 and Cu-67 by 100 MeV proton beam irradiation.

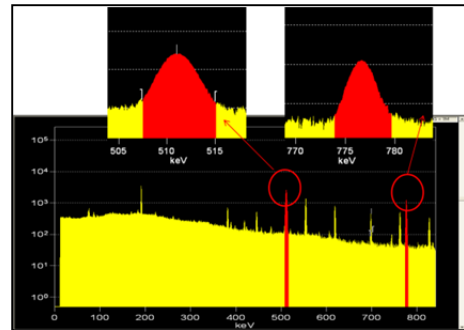

Figure 10: The gamma spectrum from RbCl target.

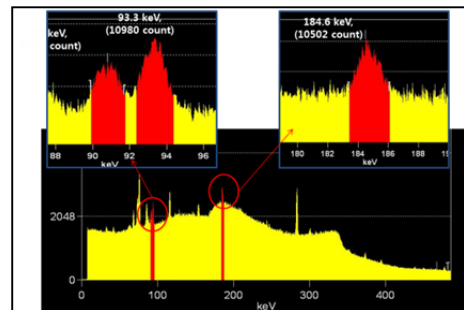

Figure 11: The gamma spectrum from Zn target.

CONCLUSION

We have completed to the construction of the RI production targetry system for the Sr-82 and Cu-67 production. And then, the low-flux beam irradiation tests for proto-type RI target have been conducted. As a result of the beam irradiation tests, we could obtain the evidence of Sr-82 and Cu-67 production, have confirmed the feasibility of Sr-82 and Cu-67 production at KOMAC RI production facility.

ACKNOWLEDGEMENT

This work was supported by the Ministry of Science, ICT & Future Planning of the Korean Government

REFERENCES

- [1] F.M. Nortier *et al.*, "Transactions of the American Nuclear Society and European Nuclear Society," TANSO 89 1-920 p.77, 2003.
- [2] J. F. Ziegler, J. P. Biersack, "SRIM-2000, 40: The Stopping and Range of Ions in Matter," IBM-Research, Yorktown, NY, USA, 2000.