

# DEVELOPMENT AND APPLICATION OF ROGOWSKI COILS AS BEAM POSITION MONITORS

F. Trinkel\*, Institute of Nuclear Physics (IKP), Forschungszentrum Jülich, 52425 Jülich, Germany, and RWTH Aachen, 52062 Aachen, Germany  
 H. Soltner, Central Institute of Engineering, Electronics and Analytics (ZEA-1), Forschungszentrum Jülich, 52425 Jülich, Germany, for the JEDI collaboration<sup>†</sup>

## Abstract

We have developed segmented Rogowski coils as a beam position monitors at the storage ring COSY Jülich as an alternative to the conventional monitors installed there. These coils feature a torus with two or four segments, each densely covered with an insulating copper wire of 150  $\mu\text{m}$  in diameter. The bunched particle beam induces voltages in these segments, which are combined and analysed to yield information about beam displacements in the horizontal and the vertical plane. The integration of such a beam position monitor with COSY and first results with it for a bunched deuteron beam are described.

## INTRODUCTION

The goal of the JEDI collaboration (Jülich Electric Dipole moment Investigations) is to measure EDMs of charged elementary particles (p and d) in the storage ring COSY (COoler SYnchrotron) at Forschungszentrum Jülich [1, 2] by observing a polarization build-up, which is perpendicular to the EDM. To create an EDM signal, a recently developed RF Wien filter introduces a vertical polarisation build-up of the circulating polarized particle beam, which is proportional to the particles' EDM and systematic effects [3, 4]. It is important to control the orbit with high precision because systematic effects may contribute to an undesired polarization build up, which may erroneously be interpreted as an EDM signal [5]. The existing orbit control system at COSY is being improved for this purpose [6]. A first step in this direction is the development of a room temperature Rogowski coil [7], which is used as a beam position monitor (BPM). It consists of a torus divided into two or four equal segments. Each segment is wound with a thin copper wire, yielding a pick up coil which detects the voltage induced by the bunched beam. With this configuration we have already shown first beam position measurements at COSY [8]. An advantage of the Rogowski coil BPM is its thickness of only 1 cm compared to the length of the existing BPMs of about 13 cm.

## DESIGN OF A ROGOWSKI COIL BPM

The idea to measure the beam position with a segmented Rogowski coil is based on the measurement of the magnetic

field induced by the particle flux. The torus can be characterised by two radii. The radius  $R$  defines the distance from the centre of the tube to the centre of the torus and the radius  $a$  is the radius of the torus itself. In the presented setup  $R = 40$  mm and  $a = 5.075$  mm, the number of windings for a quartered segmentation is  $N = 350$  and the wire thickness is  $s = 150$   $\mu\text{m}$ .

For the design of the Rogowski coil BPM the induced voltages of different coil configurations are calculated. These configurations of the Rogowski coil BPM are depicted in Fig. 1. The investigated angular ranges are listed in Table 1.

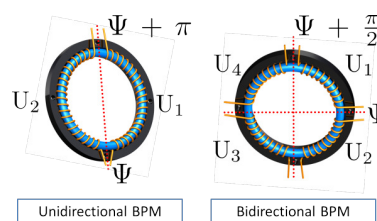

Figure 1: The halved Rogowski coil can determine a beam displacement in one direction, whereas the signals of the individual quarters in the configuration on the right hand side can be combined to yield information about displacements in both directions.

Table 1: Angular Ranges of Three Different Rogowski Coil Configurations

Angular range $\Delta\Psi$	Rogowski coil configuration
$2\pi$	full segmentation
$\pi$	halved segmentation
$\pi/2$	quartered segmentation

In [9] the theoretical description of the magnetic field generated by a bunched particle beam was derived. This is used to calculate the induced voltage up to the fifth order for  $r_0/R \ll 1$  of halved and quartered Rogowski coil BPMs. The induced voltage normalised to the angular range is

$$U_{\text{ind}} = -N \frac{d\Phi}{dt} = -\frac{N}{\Delta\Psi} \int_A \vec{B} d\vec{A}, \quad (1)$$

where  $N$  describes the number of windings on the segment,  $\Phi$  is the magnetic flux,  $\vec{B}$  the magnetic field through a loop and  $\vec{A}$  is its area. The detailed evaluation for this integral is presented in [9]. The induced voltage for a full coil ( $\Delta\Psi =$

\* f.trinkel@fz-juelich.de

<sup>†</sup> <http://collaborations.fz-juelich.de/ikp/jedi/index.shtml>

$2\pi$ ) can be found in [10].  $\Delta\Psi = \pi$  leads to the voltages  $U_1$  and  $U_2$  induced in the two halves. The horizontal voltage ratio is defined in eq. 2 and depends on the horizontal and vertical beam position.

$$\frac{\Delta U_{1/2,hor}}{\Sigma U_i} = \frac{U_2 - U_1}{U_1 + U_2} \quad (2)$$

$$= c_1 x_0 - c_2 (x_0^3 - 3y_0^2 x_0) + c_3 (x_0^5 - 10y_0^2 x_0^3 + 5y_0^4 x_0)$$

For a vertical Rogowski coil BPM the definitions have to be applied accordingly. The constants  $c_1$  to  $c_3$  depend only on the coil parameters  $R$  and  $a$ .

$$c_1 = \frac{2}{\pi\sqrt{R^2 - a^2}}, \quad c_2 = \frac{a^2 R}{3\pi(R^2 - a^2)^{5/2}(R - \sqrt{R^2 - a^2})}$$

$$c_3 = \frac{a^2 R(4R^2 + 3a^2)}{20\pi(R^2 - a^2)^{9/2}(R - \sqrt{R^2 - a^2})}$$

The definition of the horizontal and vertical voltage ratio for the quartered segmentation is shown in eq. 3.

$$\frac{\Delta U_{1/4,hor}}{\Sigma U_i} = \frac{(U_1 + U_2) - (U_3 + U_4)}{U_1 + U_2 + U_3 + U_4} = \frac{\Delta U_{1/2,hor}}{\Sigma U_i} \quad (3)$$

$$\frac{\Delta U_{1/4,ver}}{\Sigma U_i} = \frac{(U_1 + U_4) - (U_2 + U_3)}{U_1 + U_2 + U_3 + U_4} = \frac{\Delta U_{1/2,ver}}{\Sigma U_i}$$

A simulation and an accelerator measurement were performed to validate the derived theoretical model. The results will be presented in the following.

### Numerical Simulation of a Bidirectional Rogowski Coil BPM

To test the theoretical model, a numerical simulation of a bidirectional Rogowski coil BPM with a Gaussian beam is performed with the program AMPERES<sup>1</sup>. In Fig. 2 the simulation setup and the applied beam positions are presented. The coil parameters are the same as mentioned before. The body of the Rogowski coil BPM and the corresponding windings for each segment are defined and modelled on the left hand side, a sketch of the applied beam positions for the induced voltage simulation is shown on the right hand side. With the known beam position the model voltage ratios are calculated. The voltage ratios of the numerical simulation are determined by the different induced voltages at the different beam positions. A range of 10 mm in the horizontal plane and in the vertical plane with a step size of 0.5 mm is simulated. A comparison of the theoretical model and the numerical simulation is presented in Fig. 3. On the x-axis the horizontal voltage ratio is plotted and on the y-axis the vertical voltage ratio is shown. The blue dots represent the numerical simulation and the red dots the theoretical model. At first sight both descriptions of the coil are in very good agreement. To see the small differences between them calculated, see Fig. 4. The differences between model and simulation occur because of small modelling asymmetries of the windings on the torus. This asymmetry leads to a maximum localization error of about 16  $\mu\text{m}$  between the numerical simulation and the model.

<sup>1</sup> Integrated Engineering Software, www.integratedsoft.com

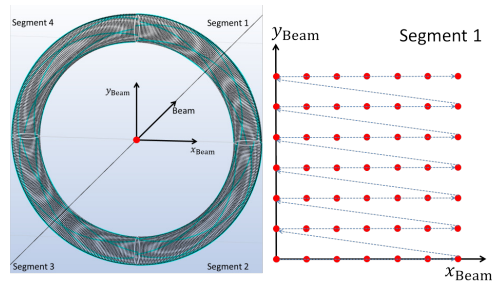

Figure 2: Simulation setup and applied beam positions. On the left hand side the model setup for the numerical simulation is presented. The beam is moved to defined positions in the horizontal and vertical plane, which is illustrated on the right hand side.

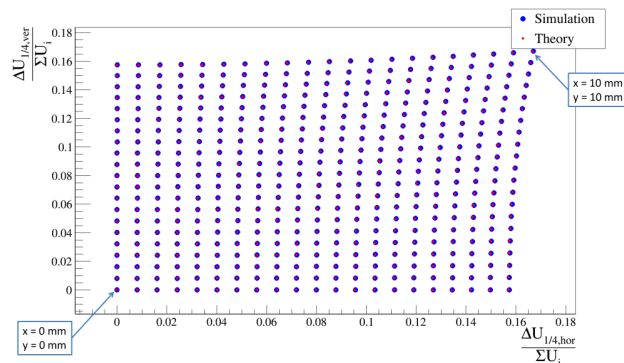

Figure 3: Comparison of the theoretical model and the numerical simulation.

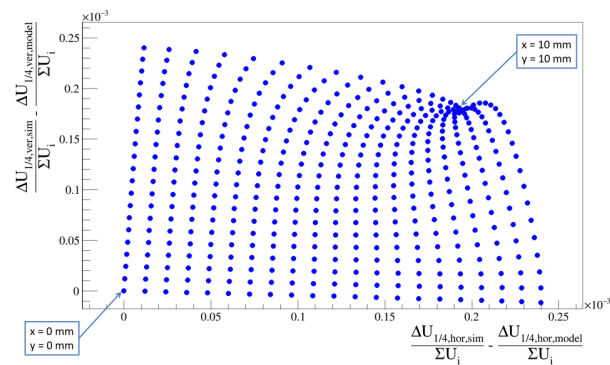

Figure 4: Residual of the numerical simulation and theoretical model of a bidirectional Rogowski coil BPM.

### Bidirectional Rogowski Coil BPM at COSY

In [8] first measurements with a bidirectional Rogowski coil BPM were performed. A bunched deuteron beam of about  $10^9$  particles with a momentum of 970 MeV/c and a revolution frequency of 750 kHz was used. The readout scheme of the Rogowski coil BPM is presented in Fig. 5. Each pick-up of the four segments is connected to a pre-amplifier with a high input impedance (0.5 M $\Omega$ ) with an amplification of 13.5 dB. The pre-amplified signals are fed into two synchronized lock-in amplifiers<sup>2</sup>. The four voltages

<sup>2</sup> HF2LI from Zürich Instruments (<http://www.zhinst.com/>)

are demodulated and recorded by the data acquisition system. The COSY RF signal is converted into a TTL pulse and used by the lock-in amplifiers as reference frequency. The chosen 3 dB filter width of the lock-in amplifier is chosen to be 6.8 Hz. This filter leads to an effective averaging time of 10.2 ms, which corresponds to about 8000 revolutions of the beam. The sampling rate of the device is set to 225 Sa/s. The setup of the local orbit bump is presented in Fig. 6. The beam is injected and stays at the initial horizontal and vertical orbit. Subsequently, a horizontal local orbit bump exerted by a corrector magnet with a certain strength is applied, whereas the vertical orbit is not affected. The measurement is repeated for different horizontal orbit bump values. A range of  $-2\%$  to  $2\%$  of maximum current of the corrector magnets with a stepsize of  $0.2\%$  is applied. The horizontal orbit change is proportional to the change of the applied corrector strength (see eq. 4).

$$x = const \cdot \Delta I, \quad (4)$$

where  $\Delta I$  is the horizontal corrector strength. For the measurement it is expected, that in first order the measured horizontal voltage ratio is proportional to the linear change of the position. To reduce systematic effects, the signal of the initial voltage ratio is subtracted from the voltage ratio, where the local orbit bump was applied

$$\Delta \frac{\Delta U_{1/4,hor}}{\Sigma U_i} = \frac{\Delta U_{1/4,hor,bump}}{\Sigma U_i} - \frac{\Delta U_{1/4,hor,initial}}{\Sigma U_i} \quad (5)$$

$$= a_1 \cdot \Delta I.$$

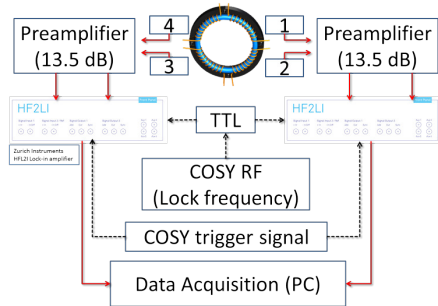

Figure 5: Readout scheme of the Rogowski coil BPM.

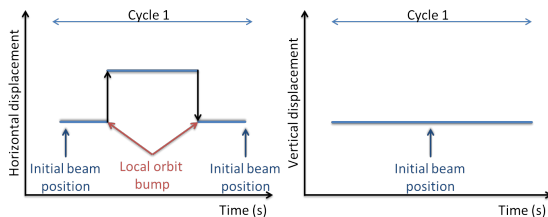

Figure 6: Setup for the local orbit bump measurement in the accelerator COSY.

The result for the horizontal voltage ratios is presented in Fig. 7. On the x-axis the horizontal corrector strength is plotted. For each applied horizontal corrector value an error of  $0.02\%$  is assumed. On the y-axis the horizontal voltage ratio is shown. A linear fit is performed with the

corresponding residual. The measured data and the theoretical prediction are in good agreement. The relative position resolution is about  $16 \mu\text{m}$ . The vertical voltage ratio in dependency of the applied horizontal corrector strength value is shown in eq. 6.

$$\Delta \frac{\Delta U_{1/4,ver}}{\Sigma U_i} = \frac{\Delta U_{1/4,ver,bump}}{\Sigma U_i} - \frac{\Delta U_{1/4,ver,initial}}{\Sigma U_i} \quad (6)$$

$$= b_1 + b_2 \cdot \Delta I + b_3 \cdot \Delta I^2$$

In Fig. 8 the dependence of the vertical voltage ratio on the horizontal corrector strength is depicted. A fit with the three free parameters  $b_1$ ,  $b_2$  and  $b_3$  of eq. 6 with the corresponding residual is applied. The fit is in good agreement with the measured vertical voltage ratio. Also for this measurement the theoretical model describes the data points.

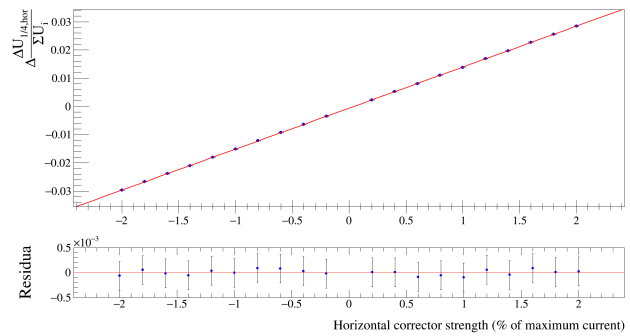

Figure 7: The relative horizontal voltage ratio in dependency of the applied horizontal bump strength.

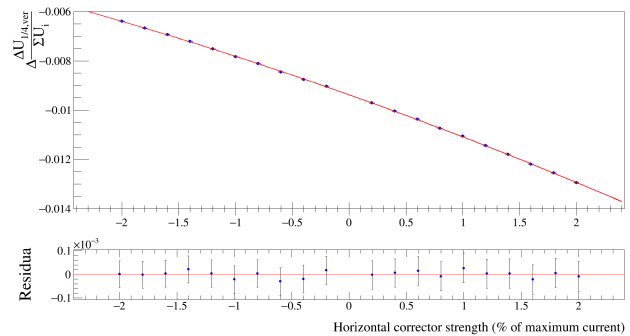

Figure 8: The relative vertical voltage ratio in dependency of the applied horizontal bump strength.

## SUMMARY AND OUTLOOK

A new concept of a Rogowski coil based BPM, which detects the horizontal and vertical beam position, is presented. A theoretical model, corresponding numerical simulations and an accelerator measurement are presented. The results are in good agreement with the theoretical model. In summer 2017, two calibrated Rogowski coil BPMs for absolute beam position detection will be installed in the vicinity of a new RF Wien Filter [11] at COSY. This permits an alignment of the particle beam with respect to the centre of the RF Wien Filter. This configuration will permit for studies of systematic effects relevant for EDM measurements.

## REFERENCES

- [1] R. Maier, "Cooler synchrotron COSY — Performance and perspectives", *Nuclear Instruments and Methods in Physics Research Section A: Accelerators, Spectrometers, Detectors and Associated Equipment* 390, pp. 1–8 (1997) [http://dx.doi.org/10.1016/S0168-9002\(97\)00324-0](http://dx.doi.org/10.1016/S0168-9002(97)00324-0)
- [2] C. Weidemann, F. Rathmann, H. Stein, *et al.*, "Toward polarized antiprotons: Machine development for spin-filtering experiments", *Physical Review Special Topics - Accelerators and Beams* 18, 020101 (2015) <http://dx.doi.org/10.1103/PhysRevSTAB.18.020101>
- [3] F. Rathmann, A. Saleev, N. N. Nikolaev, "The search for electric dipole moments of light ions in storage rings", *Journal of Physics: Conference Series* 447, 012011 (2013), <http://dx.doi.org/10.1088/1742-6596/447/1/012011>
- [4] W. M. Morse, Y. F. Orlov, Y. K. Semertzidis, "rf Wien filter in an electric dipole moment storage ring: The 'partially frozen spin' effect", *Physical Review Special Topics - Accelerators and Beams* 16, 114001, (2013), <http://dx.doi.org/10.1103/PhysRevSTAB.16.114001>
- [5] M. Rosenthal, A. Lehrach, "Spin Tracking Simulations Towards Electric Dipole Moment Measurements at COSY", in *Proceedings 6th International Particle Accelerator Conference, IPAC'15*, Richmond, VA, USA (2015). <http://jacow.org/IPAC2015/papers/thpf032.pdf>
- [6] C. Böhme, M. Bai, F. Hinder, V. Kamerdzhev, F. Trinkel, (2016, January), "Studies for a BPM Upgrade at COSY", *4th International Beam Instrumentation Conference (IBIC 2015)*, Melbourne, Australia, 13-17, September 2015., JACOW, Switzerland, 2016, <http://juser.fz-juelich.de/record/827385>
- [7] W. Rogowski, W. Steinhaus, "Die Messung der magnetischen Spannung", *Archiv für Elektrotechnik* 1, pp. 141–150 (1912), <http://dx.doi.org/10.1007/BF01656479>
- [8] F. Trinkel, F. Hinder, D. Shergelashvili, H. Soltner, "Beam Based Calibration of a Rogowski Coil Used as a Horizontal and Vertical Beam Position Monitor", in *Proc. of International Beam Instrumentation Conference (IBIC'16)*, Barcelona, Spain, Sept. 13-18, 2016, <http://jacow.org/ibic2016/papers/tupg01.pdf>
- [9] F. Hinder, F. Trinkel, H.-J. Krause, H. Soltner, "Development of New Beam Position Monitors at COSY", in *IBIC 2015 International Beam Instrumentation Conference Proceeding*, TUPB015, IBIC'15, Melbourne, Australia (2015) <http://ibic.synchrotron.org.au/papers/tupb015.pdf>
- [10] M. Rezaee, H. Heydari, "Mutual inductances comparison in Rogowski coil with circular and rectangular cross-sections and its improvement", in *2008 3rd IEEE Conference on Industrial Electronics and Applications*, 2008, 10.1109/ICIEA.2008.4582770
- [11] J. Slim, R. Gebel, D. Heberling, F. Hinder, D. Hölscher, A. Lehrach, B. Lorentz, S. Mey, A. Nass, F. Rathmann, L. Reifferscheidt, H. Soltner, H. Straatmann, F. Trinkel, J. Wolters, "Electromagnetic Simulation and Design of a Novel Waveguide RF Wien Filter for Electric Dipole Moment Measurements of Protons and Deuterons", in *Nuclear Instruments and Methods in Physics Research Section A: Accelerators, Spectrometers, Detectors and Associated Equipment*, 2016, <http://www.sciencedirect.com/science/article/pii/S0168900216303710>