

RF-MECHANICAL DESIGN AND PROTOTYPING OF THE SPES RFQ

L. Ferrari, A. Palmieri, A. Pisent INFN-LNL, Legnaro (PD), Italy

Abstract

The SPES RFQ is designed in order to accelerate beams of exotic isotopes in CW with A/q ratios from 3 to 7 [1]. The RFQ is composed of 6 modules about 1.2 m long each. Each module is basically composed of a AISI304 L SS Tank and four OFE Copper Electrodes (obtained by brazing of two subassemblies in order to spare material). A copper layer is plated on the tank inner surface and a spring joint between tank and electrode is used in order to seal the RF. In this paper the main result of the design of the RFQ (with particular focus on the RF-mechanical aspects and thermo-structural calculations), the RFQ prototyping strategy as well as the construction and assembly procedure of RFQ modules are described.

SPES RFQ GENERAL DESCRIPTION

The SPES RFQ [1] is designed in order to accelerate beams from 5.7 to 727 keV/u in CW with A/q ratios from 3 to 7 from the Charge Breeder through ALPI Superconducting Linac. The RF frequency is 80 MHz, the vane length is 6.95 m and the pole tip radius varies between 4.01 and 5.97 mm (0.76 R_0). The voltage profile vs z is linear in the range 63.8 – 85.84 kV, for $A/q=7$. The RFQ layout is shown in Figure 1.

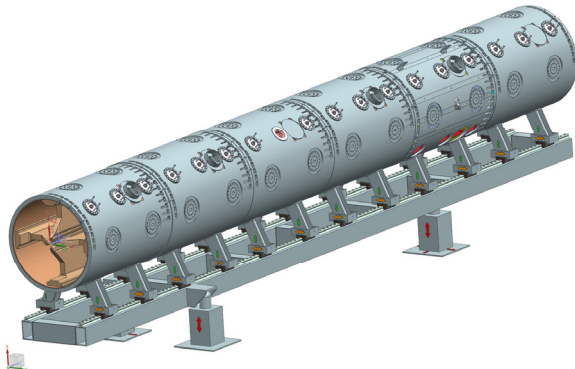

Figure 1: The SPES RFQ layout.

3D RF CONSIDERATIONS

As for RF study is concerned, the number and position of tuners was determined, as well as the dimensions of the vane undercuts. As for tuner positions, for the given R_0 sensitivity (3.3 MHz/mm), the idea is to allow a maximum ΔR_0 variation of $\Delta R_{0,max} = \pm 175 \mu\text{m}$ all along the RFQ and a maximum voltage error $|\delta V/V_0| < 0.03$ both for Quadrupole and Dipole perturbing components. This determines the frequency tuning range $[f_0 - \chi_{R0}\Delta R_0^+, f_0 + \chi_{R0}\Delta R_0^-] = [79.5\text{MHz}, 80.5\text{MHz}]$. The number of tuners is $N_T=68$ (17 per quadrant), with radius $a=59$ mm: the average tuner sensitivity is equal to about $\chi_{\text{tun}} = 13$ kHz/mm

(all tuners), plus 3 extra tuners located at coupler position, corresponding to $h_t=[h_{\min}, h_{\max}] = [-10 \text{ mm}, 80 \text{ mm}]$. The RF power value is equal to 115 kW (with 30 %margin for 3D details and RF joint, and 20% margin for LLRF regulation), corresponding to $Q_0=16100$. Since all the RFQ sections have the same cut-off frequency, the end cell tuning is obtained by tuning the low [high] energy cell high [low] in frequency with respect to the RFQ. The dimensions of the undercuts were optimized with HFSS simulations. Finally, the whole length RFQ (included modulation) underwent a combined ANSYS-HFSS RF and thermo-structural simulation. In Figure 2 the vane voltage V calculated in some RFQ sections with the Faraday-Neumann law is shown in three different cases, showing an agreement within $\pm 4\%$. This value (not yet tuned) can be considered as a validation of the RF design [2].

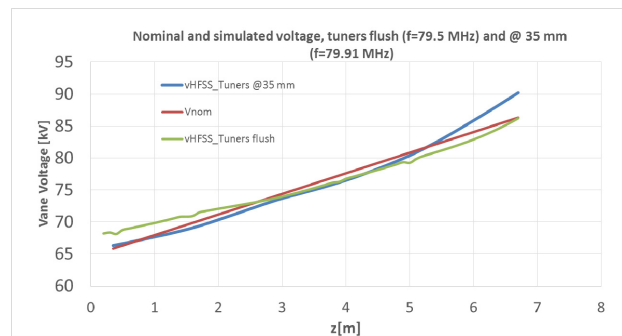

Figure 2: The RFQ voltage: nominal (red curve), tuner flush simulated (blue curve), tuners at $h_{t0}=35$ mm (blue curve). The simulation was performed on $1/4$ RFQ with 3 million mesh elements.

The thermo-mechanical calculations also allowed to determine the temperature distribution in the vacuum grids. In particular, the vacuum grid is made in SS with Electrodeposited Cu and is cooled with 6 mm diameter channels (Figure 3).

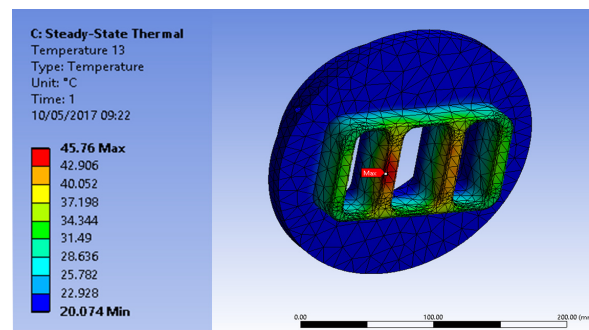

Figure 3: Vacuum grid temperature distribution ($T_{\text{inlet}}=20^\circ\text{C}$, $h_c=4000 \text{ W}/(\text{m}^2\text{K})$, $T_{\text{max}}=45^\circ\text{C}$).

ELECTRODE-TANK INTERFACE

Since the ΔR_0 final values are determined by the electrode vs. tank positioning, it is indispensable to guarantee a reliable and precise setup for such an assembly, with a precision in the order of tenths of μm . The interface joining the Electrode (EL) to the Tank (T) (Figure 4) is made of two SS316LN Stainless Steel inserts, brazed on the electrode, on which cooling channels tube housings are placed, as well as an energized C-seal for vacuum sealing. The RF joints (2 per electrode) are a multi-louver reed-shaped springs in copper, silver-plated and mounted on a stainless steel carrier. Such joints are to be contemporarily pushed against the inner tank surface with an overall 8 kN force (8N/louver) on the whole electrode length. The spring C-seal, indeed, 60kN (167N/mm on the circumference) each for tightening. Now, since the contemporary tightening of the two C-seals is not feasible, this interface was modeled in order to avoid dangerous stresses on the electrode, by making the assembly of one insert independent on the assembly of the other one.

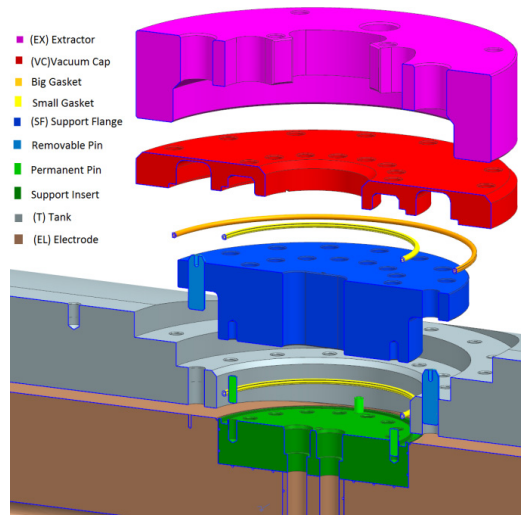

Figure 4: Section of the Support System.

The Support Flange (SF) made of 316LN has the grooves for two small gaskets and through holes (SF) for screws and cooling pipes. The external support flange hole pattern is in vacuum and will be enclosed in a donut-shaped Vacuum Cap (VC) via both an inner and an outer gasket. The stop surface with the tank has to be machined according with mechanical measurements to be performed in situ, in order both to avoid electrode deformations and proper electrode positioning with respect to tank axis. The Vacuum Cap (VC) has to guarantee vacuum tightness. Moreover, due to its relatively thin (1.5 mm) surface avoids stresses that could be induced by the non-parallelism of the two gasket stop surfaces. Finally, the Aluminum Extractor (EX) is such to house the SF, to tighten the RF joint, and to pull the electrode, as well as to allow the alignment pin insertion/extraction. In order to validate the above-described assembly system, two prototypes were built and measured. The first one was aimed at validating the brazing interface setup and the functionality

of all the components, while the second one was aimed at determining possible issues in the electrode-vs-tank alignment assembly, via the usage of an electrode simulator with two inserts.

FIRST RFQ TEST PROTOTYPE

The 1st prototype simulates is shown in Figure 5. A INOX316LN SS plate is brazed on a CuC2 mini-electrode by using PalCuSil@10 (liquidus@852°C). The electrode is equipped with two grooves for the RF joints (LaCuD-15 ® from Multi-Contact) and is joined to a 30 mm thick Al plate.

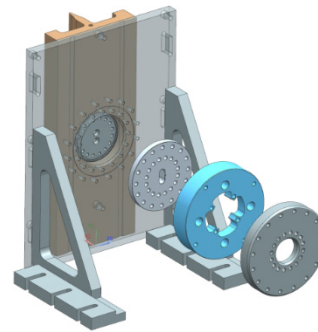

Figure 5: Main first prototype components. From the left to the right: EL, T, SF, EX, VC.

As a first step the brazed insert was checked with ultrasounds, then it was assembled according to the following procedure:

- 1) Reference measurement in nominal position for RF joint and gasket grooves.
- 2) Support flange machining according to 1)
- 3) Manual displacement of the electrode for RF joint and C-shaped gasket insertion (without crushing)
- 4) RF joint crushing with the EX
- 5) Tightening of the first gasket between the insert and the SF (25 Nm torque).
- 6) Release of the RF joint and closing of the SF-Tank interface
- 7) Tightening of all the nuts in order to fix the SF to the tank
- 8) Further pre-load (final torque 50 Nm) of the previously used studs to tighten the inner gasket, in order to avoid its loosening
- 9) VC assembly by tightening inner and outer gaskets.
- 10) Insert post-assembly measurement

The measuring instrument is a portable CMM CimCore infinite 2.0 arm (Volume length accuracy 0.029 mm, point repeatability 0.02 mm) equipped with Calypso Zeiss software for measured point post-processing

As for results is concerned, the brazing alloy was correctly distributed along the braze surfaces. Moreover, the RF joint showed an elastic behavior (as expected), and the gaskets behaved according to specifications. The electrode positioning was not affected by the non-planarity of the mechanical stop and the 1.5 mm thickness of the VC

was got deformed, since it had to re-adapt itself to the gasket stops. This circumstance was expected as well. Finally, the electrode experienced a rotation about the support axis. This was due to the placement of the RF joints, which, during compression, generate a torque. In order to avoid this effect, in the final setup, two extractable pins on the SF-T interface will be foreseen.

SECOND RFQ TEST PROTOTYPE

The second prototype, shown in Fig. 6, is made of Aluminum, except for the SF, VC and EX components. Differently from the previous prototype, the RF joint tightening has to occur at the same time for the two inserts. The assembly procedure followed the same steps of previous case, except for the fact that between steps 4) and 5) the alignment pins were inserted. Mechanical measurements were performed on the inserts, but also on two perpendicular planes of the electrode, in order to investigate the insert-mounting induced displacements. For better clarity, the planes XY and XZ were sectioned on two different longitudinal positions (Z_{top} and Z_{bottom}), so that four different lines (X Top, Y Top and X Bottom, Y Bottom) resulted. (Figure 6). In Figure 7 the related results are shown.

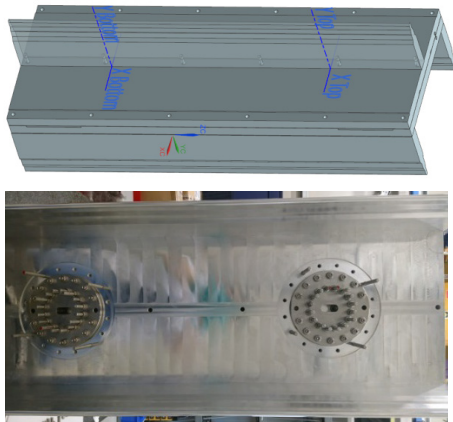

Figure 6: Top: second prototype with the lines obtained from the sections at different longitudinal positions; Bottom: Photo of the prototype 2 with SFs mounted.

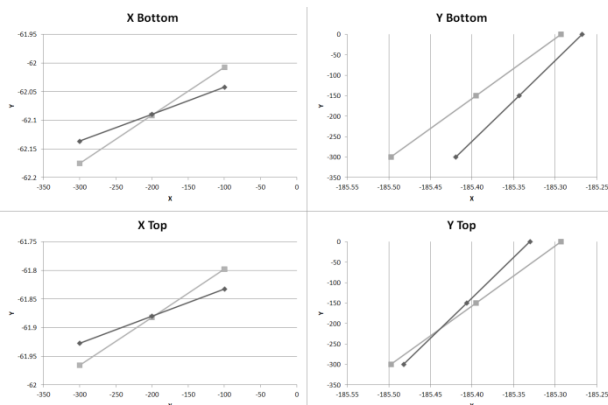

Figure 7: Cut-lines of the prototype before (light grey) and after (dark grey) mounting along X and Y directions.

It has to be noticed that, while in the Y direction, the assembly displacement is less than 0.05 mm, on the X direction such value is in the order of 0.15 mm. This discrepancy was found to be due to a machining error of the lower flange pin grooves. Therefore, also in this case, the mounting procedure is considered to be validated.

RFQ ELECTRODE CONSTRUCTION

The SPES RFQ electrode construction procedure consists of the following steps:

- 1) Procurement of the raw material (mechanical characterization: grain size, tensile test, hardness test)
- 2) Rough machining of the T-shaped Cu blocks
- 3) Deep drilling
- 4) Annealing for the stresses relaxation (3h@600°C)
- 5) Deep holes machining and mapping with the UT and minimization of the hole deviations
- 6) Pre-finishing of the Cu-block for the brazing
- 7) Dimensional control of the brazing interfaces
- 8) UHV cleaning
- 9) Brazing of the SS support on the Cu bulk
- 10) Test: Leak and Pressure of the cooling channels, Ultra Sound of the brazed surfaces
- 11) Finishing of the interface surfaces (support insert)
- 12) Finishing of the modulation
- 13) Dimensional control of the 3D-surfaces
- 14) UHV cleaning
- 15) Packaging and delivery to INFN.

The RFQ electrodes are being constructed by CINEL Strumenti Scientifici S.r.l. of Vigonza (PD), Italy and, as for May 2017, the 1st set of 4 electrodes (module 5) was successfully delivered. In particular, the mechanical measurements (Figure 8) showed that the modulation and the electrode geometry profile were within the specifications.

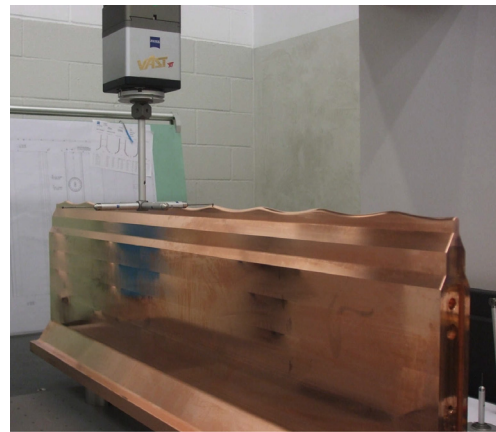

Figure 8: A RFQ electrode set up for factory mechanical measurements.

REFERENCES

- [1] L. Ferrari *et al.*, HIAT 2015, WEPB13, Yokohama, Japan.
- [2] A. Pisent *et al.*, "IFMIF-EVEDA RFQ DESIGN", Proceedings of EPAC08, Genoa, Italy p. 3542.