

# TRAVELLING LASER FOCUS SYSTEM FOR THE PARTICLES ACCELERATION

A. Mikhailichenko, Cornell University, CLASSE, Ithaca, NY14853, USA

## Abstract

We describe results of calculations with FlexPDE code of wake-fields induced by bunch in the micro-structures. These structures, illuminated by swept laser bust, serve for acceleration of particles.

## OVERVIEW

Future of High-Energy physics in a post-Standard Model world associated with search of new technologies suitable for particles acceleration. Crucial criterions are the rate of acceleration and luminosity. In [1, 2] we made description of method of acceleration based on local excitation of microstructure by swept laser radiation. This method, based on idea disclosed in [3], was called a Travelling Laser Focus (TLF). In Fig.1 the photon bunch with length  $c\tau \sim 3cm$  swept transversely in direction of particle motion by fast device arranged by many electro-optical prisms with reversing orientation of optical axes [2]. Semi-transparent mirrors split the tilted laser burst in fractions and direct each fraction to its individual accelerating structure.

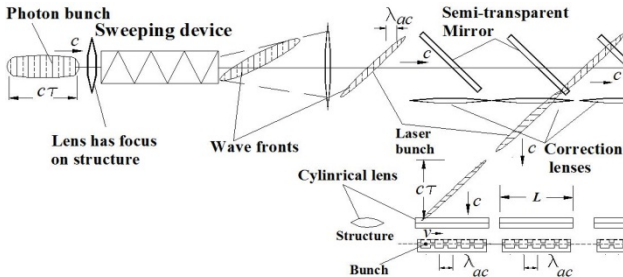

Figure 1: Long term acceleration system with sweeping device [1]. Optical amplifier could be installed after sweeping device (or in front of each cylindrical lens).

Usage of sweeping device has undoubted advantages with other possible method obtaining the tilted laser bunch with help of grating, see [1]. Acceleration in any structure is going by interaction of particles with standing (in transverse direction) wave, so basically this is interaction with *two* waves propagating oppositely in transverse direction; this allows exclusion of magnetic field action while the particle crosses the center of (micro) cavity. Using the quantum mechanical language one can say that acceleration happens thanks to interaction of particle with *two* photons synchronously moving in transverse direction. So the presence of two photons (standing wave) is important in acceleration process. Otherwise the scattering on EM wave reduces achievable rate by Compton-effect. That is why acceleration with the only

single tilted laser bunch like in [4] is not working. In our case the standing wave arranged inside tiny accelerating cells by multiple reflections. As a baseline we have chosen a foxhole type of structure excited from the open side, introduced in [5,6]. We are suggesting weak inductive coupling with the outer space, so the electric field at open side is  $\sim 0$ , but magnetic field has maximal value there. The height of structure should be then  $\sim$ half of the wavelength in a groove-  $\lambda_w/2$ , where  $\lambda_w \equiv \lambda_{ac} / \sqrt{1 - (\lambda_{ac} / 2W)^2} / 2$ ,  $W$  is the width of cell,  $\lambda_{ac}$  is a wavelength of laser radiation in free space, see [2]. Isometric 3D view of structure with cylindrical lens is represented in Fig.2

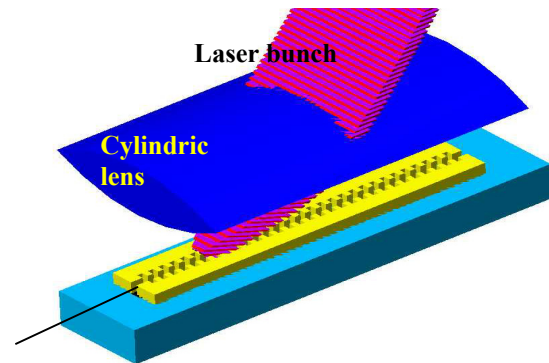

Figure 2: Accelerating structure is open at one side. The beam is going inside at distance  $\sim \lambda_w / 4$  from the bottom plate (magenta). Laser bunch is shown painted rose.

Parameters of accelerating complex are represented in Table 1 below, see [1, 2] for details.

With this system it is possible to arrange collisions with  $e^\pm, \mu^\pm, p^\pm$  and even  $\pi^\pm$  [2] in any combination of these.

## MODEL

For calculation of fields of radiation we used a FlexPDE code [7]. Model of acceleration structure with 15 cells was erected, Fig. 3. The front and back walls were made resistive. Calculation of wakes was an issue. Equations for vector and scalar potentials were appointed for modeling

$$\Delta \vec{A} - \frac{1}{c^2} \ddot{\vec{A}} - \kappa \dot{\vec{A}} = -\mu_0 \vec{j}, \quad \Delta U - \frac{1}{c^2} \ddot{U} = -\frac{1}{\epsilon_0} \rho(x, y, z, t), \quad (1)$$

where  $\mu_0, \epsilon_0$  are magnetic permeability and electric permittivity of vacuum respectively,  $c$  is a speed of light.

Term with decrement  $\kappa \dot{\vec{A}}$  describes the losses in walls-  $\kappa = 1/(c^2 \tau) = 1/(Q \lambda_{ac} c)$ ,  $\tau$  is the field decay time,  $Q$  is a quality factor. Such introduction of losses suggests volume losses although the real losses happen on surface.

The volume losses introduced by such a way are self-consistent. For the bunch shape an approximation was used as (motion is going in  $y$ -direction,  $v=\beta c$ )

$$\rho = 0, \text{ if } y/\sigma_y < -\pi/2 + vt/\sigma_y \text{ or } y/\sigma_y > \pi/2 + vt/\sigma_y,$$

$$\text{else } \rho \cong \frac{2Q}{\pi^2 \sigma_x \sigma_y \sigma_z} \text{Sin}^2 \left( \frac{y-vt}{\sigma_y} + \frac{\pi}{2} \right) \cdot \exp \left( -\frac{x^2}{2\sigma_x^2} - \frac{z^2}{2\sigma_z^2} \right).$$

Table 1: Parameters of Collider Driven by TLF

Energy of $e^\pm$ beam	$2 \times 1 \text{ TeV}$
Total two-linac length	$2 \times 100 \text{ m}$
Wavelength of laser radiation	$\lambda_{ac} \cong 1 \mu\text{m}$
Luminosity	$10^{35} \text{ cm}^{-2} \text{ s}^{-1}$
Main linac gradient	$>10 \text{ GeV/m}$
Bunch population, $N_b$	$3 \cdot 10^5$
Bunch length $\sigma_y$	$0.1 \lambda_{ac}$
$\sigma_x, \sigma_z$	$0.025 \lambda_{ac}, 0.1 \lambda_{ac}$
$\gamma \varepsilon_x / \gamma \varepsilon_y$	$5 \cdot 10^9 / 1 \cdot 10^9 \text{ cm-rad}$
No. of bunches/train	$<30$
Laser flash energy	$100 \mu\text{J/section}$
Total laser flash energy	$2 \times 0.3 \text{ J}$
Laser beam power	$2 \times (0.3-3) \text{ kW}$
Laser density@Acc.Structure	$0.3 \text{ J/cm}^2$
Illumination time	$<0.3 \text{ ps}$
Length of section	$\approx 3 \text{ cm}$
Repetition rate	$1-10 \text{ kHz}$
Damping ring energy	$2 \text{ GeV}$
Wall plug power*	$2 \times (3-30) \text{ kW}$

\* Without supplementary electronics.

Usage of sin-like-squared shape of bunch allows it's localization in 3D without long tails in longitudinal direction. In a transverse direction finite extension is less important.

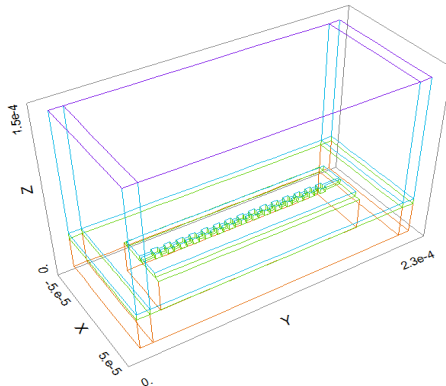

Figure 3: The geometry of problem box.

Boundary conditions for vector potential were chosen to be zero for tangent to surface components  $A_\tau = 0$ ; normal components satisfy conditions  $\partial A_n / \partial n = 0$ , potential  $U = 0$  at boundary. Current density, magnetic and electric fields defined as usual

$$\vec{j} = \rho \vec{v}, \quad \vec{B} = \text{curl} \vec{A}, \quad \vec{E} = -\partial \vec{A} / \partial t - \text{grad} U. \quad (2)$$

The current has only  $y$ -component basically. Energy lost by bunch evaluated by

$$\Delta \varepsilon = \int dt \int (\vec{j} \cdot \vec{E}) dV = - \int dt \int \vec{j} \cdot (\partial \vec{A} / \partial t + \text{grad} U) dV. \quad (3)$$

ISBN 978-3-95450-182-3

4614

Parameters of structure represented in Table 2.

Wavelength, $\lambda_{ac}$	$1 \mu\text{m}$
Width of cell, $W$	$0.6 \lambda_{ac}$
Accelerating gap, $g$	$0.5 \lambda_{ac}$
Height of structure, $h$	$0.8 \lambda_{ac}$
Width of pass slot, $\delta$	$0.2 \lambda_{ac}$
Quality factor, $Q$	10

(While making measurements of characteristics of structure in presence of air, one should take into account dielectric permittivity of air,  $1.000536 \varepsilon_0$ ).

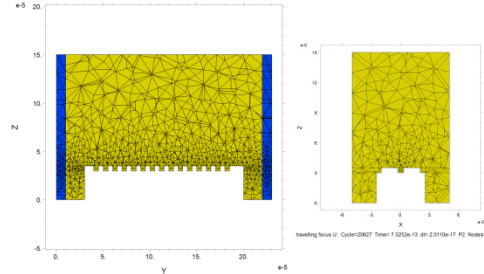

Figure 4: Mesh. The side regions with increased dissipations are painted blue.

Moving mesh generated automatically for delivering accuracy of calculations  $\cong 5 \cdot 10^{-4}$ , see Fig.4. Calculated wake-fields are represented in Figs. 5-10. Basically each of these figures is a frame from movie created by code.

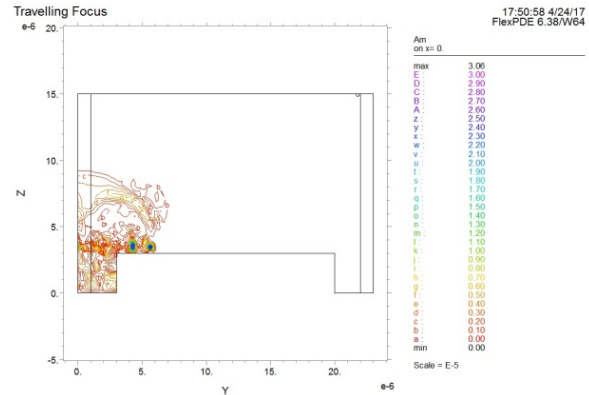

Figure 5: Wake fields contour in a plane running across the center of foxhole structure. Bunch passed two cells.

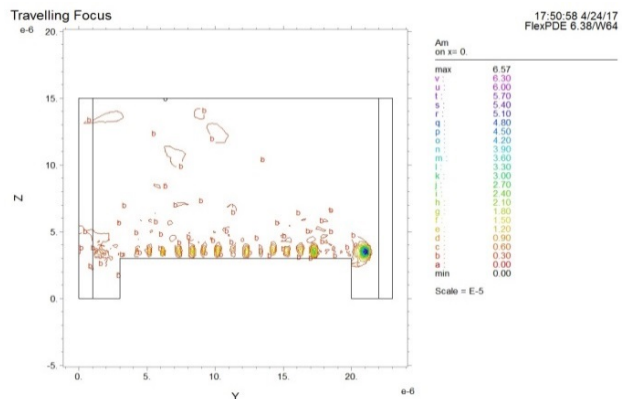

Figure 6: Module of vector potential for the bunch, exited the structure. As the plane of figure is running along the mid of structure, the walls of structure do not appear.

One can see on Fig.6, that the fields are practically scattered in outer volume to the moment of arrival of bunch to the boundary; they are located in cells mostly.

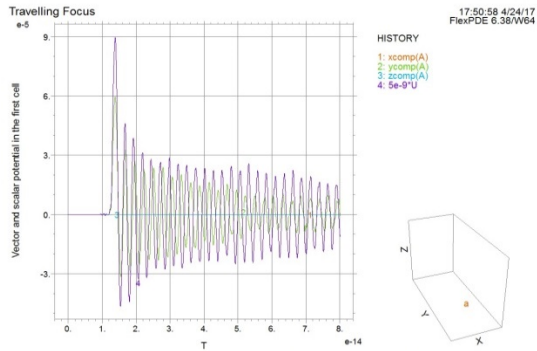

Figure 7: The fields in the first cell as functions of time.

Resonant frequency of cell could be extracted from this graph in Fig.7. This procedure will take into account existence of slots etc.

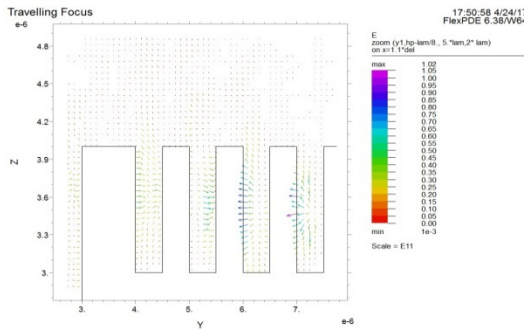

Figure 8: Vectors of  $\vec{E}$ , while the bunch is in a cell.

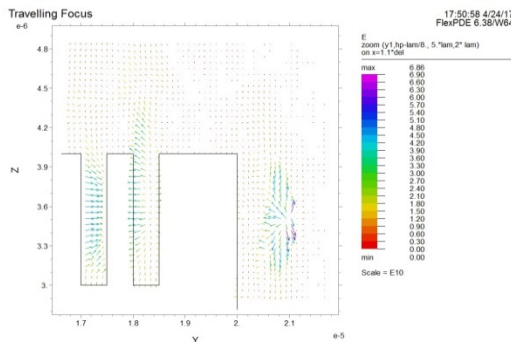

Figure 9: Vectors of  $E$ , while the bunch came out of structure. Moving window; a frame from movie.

Calculations take ~4.5 hours with PC equipped with Xeon E5-1620 for structure with 15 cells with accuracy  $\sim 10^{-3}$  and 12 individually recorded movies.

We would like to underline that as the wave fronts reach the open side of structure practically parallel to it, the periodicity of cells corresponds to  $\pi$  mode as a simplest one for this geometry. Other than  $\pi$  mode regime will require some tilt of wave fronts or cells spacing [2].

One should remember also that scaling of wakes in a cell is going linearly with dimensions. As the distances between focusing elements (see [2]) are also dropping linearly with wavelength, so the wakes action remains about the same as for X-band structure. One should

remember that TLF requires  $\sim 3 \times 10^5$  particles only.

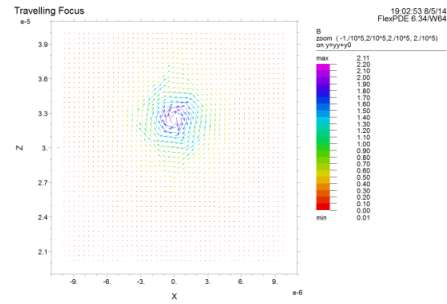

Figure 10: Vector  $\vec{B}$  across the center of bunch which escaped the structure. Frame from a movie.

## SUMMARY

The code written in FlexPDE demonstrates stable operation and results of calculations look realistic. Calculations show, that the field induced by the bunch in each individual cell exists for few periods, demonstrating agreement with quality factor  $Q=10$ . This is indication of fact that induced radiation does not escape easily from cells for chosen coupling. This was found first in [3] with GdfidL code [8], see [2].

Choice of wavelength  $\lambda_{ac} \approx 1 \mu m$  makes fabrication more difficult, than for  $\lambda_{ac} \sim 10 \mu m$  one. From the other hand operation with shorter wavelength makes laser system easier. Final choice could be done later.

Scalar potential  $U$  demonstrates a wave-like behavior, as it could be seen from Fig.7. Basically this could be supported thanks to Lorentz calibration which is hidden behind equation (1):  $div \vec{A} + 1/c^2 \cdot \partial U / \partial t = 0$ .

Tiny transverse dimensions of passing slots between cells  $\delta = 0.1 \lambda_{ac}$ , require emittances  $\gamma \epsilon_{x,z} \approx 10^{-9} cm \cdot rad$ .

These could be obtained for the bunch with population  $N_b \approx 3 \cdot 10^5$  by scrapping extra particles from bunches populated traditionally- with  $N_b \approx 2 \cdot 10^{10}$ , but having emittances  $\gamma \epsilon_{x,z} \approx 10^{-7} cm \cdot rad$ , (ILC damping ring vertical emittance corresponds to the horizontal emittance in TLF system), see [2].

Wakes generated by bunch mostly at the edges of structure, so smoothing of these regions require attention.

## REFERENCES

- [1] A.Mikhailichenko, "Laser Driven Linear Collider", EPAC 2008, Published in Conf.Proc. C0806233 (2008) WEPP155.
- [2] A.A.Mikhailichenko, "Particle Acceleration in Microstructures Excited by Laser Radiation", CLNS 00/1662, Cornell 2000.
- [3] A.A. Mikhailichenko, "The Method of Acceleration of Charged Particles", Author's certificate USSR N 1609423, Priority-May 1989, Bulletin of Inventions, N6, p.220, 1994.
- [4] T.Plettner *et al.* PRST, 12, 101302 (2009).
- [5] R.C. Fernow, J. Claus, BNL -52336, UC-414, 1992.
- [6] J.Claus, "Energy Efficiency and Choice of Parameters for Linear Colliders", Italy, May 1986. 34 pp., BNL -38947, CONF-850570-2.
- [7] FlexPDE, <http://www.pdesolutions.com/>.
- [8] W. Bruns, GdfidL, TU Berlin, 1997.