

ORBIT CORRECTION WITH PATH LENGTH COMPENSATION BASED ON RF FREQUENCY ADJUSTMENTS IN TPS

P. C. Chiu, K. H. Hu, C. H. Huang, C. Y. Liao, C. C. Liang,
 Y. C. Liu, C. C. Kuo, F. H. Tseng, H. J. Tsai, K. T. Hsu
 NSRRC, Hsinchu 30076, Taiwan

Abstract

The 3 GeV Taiwan Photon Source has been routinely operated for public users since September 2016. Orbit reproducibility and stability are critical for the quality of user experiments. Ambient temperature variations and earth tides can cause a change in circumference, changing in turn the beam energy, and orbit drift. Therefore both, orbit correction and rf frequency adjustments are necessary to keep the ring circumference constant. A Fast Orbit Feedback (FOFB) system combined with rf frequency correction deduced from the fast corrector strengths is applied to the FOFB routine. The correlation between the measured frequency variation with ambient temperature and earth tides is also reported in this article.

INTRODUCTION

The TPS is a state-of-the-art synchrotron radiation facility featuring ultra-high photon brightness with low emittance [1] and requires beam position stability of less than 10% of the beam size. Therefore, FOFB have been adopted to stabilize the electron orbit [2,3]. Later, closed orbit correction methods by RF frequency correction have been developed to compensate for orbit path length changes. Two schemes were introduced and compared and both use the RF cavity frequency as an extra parameter together with FOFB to minimize the error between the horizontal reference orbit and the measured orbit. FOFB together with RF frequency corrections have been in routine operation since September 2016. The orbit stability has been effectively improved and can achieve sub-micron stability in both horizontal and vertical planes. While applying RF corrections, long-term observations of the RF frequency variations exhibit clear signs of periodic changes and show strong correlations with temperature changes and earth tides as will be discussed below.

RF FREQUENCY CORRECTION FOR PATH LENGTH COMPENSATION

RF frequency correction is used to minimize path length changes caused mainly by temperature drifts and earth tides. Although the FOFB system could compensate some of these path length changes, residual differences up to several tens of microns remain after some 24-hour operation. Furthermore, this error would be amplified ten times as observed at the end of beamline XBPM which was unacceptable. Thus, RF correction was soon implemented and applied after FOFB commissioning. As a result, the orbit drift can be controlled and limited to

less than 1 um from day to day. Initially, there are two schemes which have been implemented and applied for RF frequency correction which will be described below.

Scheme 1

The FOFB is applied to suppress horizontal orbit disturbances or drifts. The RF correction process polls all fast horizontal corrector currents, ΔI , at 1 Hz and converts them to corresponding orbit deviations with the response matrix R. Then, the dispersion function D is used to calculate the required RF frequency change Δf_{rf} to be applied to the RF cavities. The RF frequency correction is a slow process and restricted to less than 1 Hz change per step to prevent overshooting the frequency change given by

$$\Delta f_{rf} = D^+ * RM * \Delta I,$$

where D^+ is the pseudo-inverse of D. Figure 1 shows the block diagram for the controls based on scheme 1.

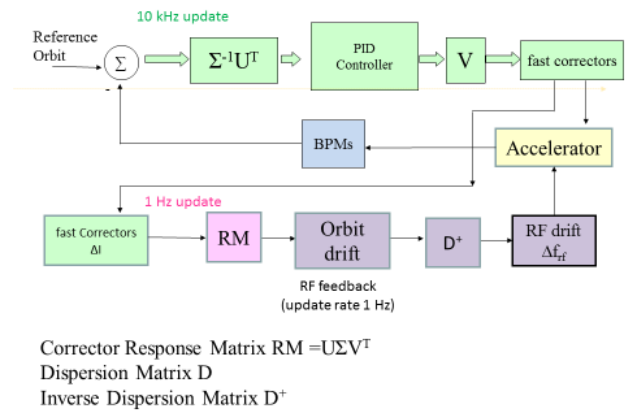
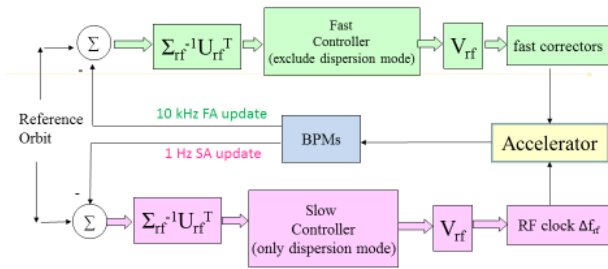

Figure 1: Scheme 1 of FOFB with RF correction (schematic).

Scheme 2

Here FOFB and RF path length compensation operate simultaneously for horizontal orbit distortions with different updating rates of 10 kHz and 1 Hz respectively. Both loops adopt the same response matrix RM_{rf} including RF frequency adjustment to stabilize the electron orbit. By means of the SVD (singular value decomposition) method, the FOFB excludes dispersion-like noise while the RF path length correction suppresses only dispersion-like noise signals. The SVD method allows independent mode operation such that the two feedback loops do not interfere. Figure 2 shows the schematic block diagram of Scheme 2 and Fig. 3 displays

the normalized dispersion function and the first eigen-space of the BPM orbit, respectively. Here both are strongly related and therefore mapping of the orbit can be referred to as the extracted dispersion-like orbit.



Corrector Response Matrix RM
 Dispersion Matrix D
 Response Matrix with Corrector & RF $RM_{rf} = [RM \ D] = U_{rf} \Sigma_{rf} V_{rf}^T$

Figure 2: Scheme 2 of FOFB with RF correction.

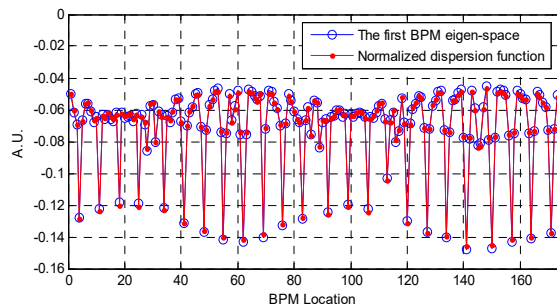

Figure 3: The first eigen modes (the first column of the U matrix) and normalized measured dispersion function. Both are highly correlated.

Comparing Schemes 1 and 2, we note that Scheme 1 has the advantage of a higher bandwidth to reduce fast dispersion-like noise in spite of motor driven tuners slowing the RF cavity response. But the disadvantage is that even small dispersion-like orbit changes of only some 20 μm (equaling to about $\Delta f_{RF} = 20$ Hz) cause FOFB saturation while Scheme 2 is less susceptible to saturation because the FOFB controller excludes dispersion eigenmode noise, but it can only suppress very slow dispersion-like variations below 0.1 Hz. Because we observe dispersion-like noise at around 0.4 Hz during routine TPS operation, Scheme 1 is applied. The upper plot of Fig. 4 shows one BPM reading at 10 Hz and the corresponding dispersion-like orbit change while the lower plot shows their spectra. It can be observed that there are dispersion-like orbit disturbance at 0.3~0.5 Hz contributing the major part of horizontal orbit variations except for disturbances from the 3 Hz booster power supply ramping. In addition, a long-term path-length drift due to temperature change and tides can be noticed. Figure 5 shows a comparison of Schemes 1 and 2 for the RF frequency correction. It shows that the orbit variation due to path length change around 0.4 Hz is too fast to be directly compensated by RF frequency correction while the FOFB has enough bandwidth. We also note that

sometimes these variations can be up to 20 μm in high dispersion areas and might cause temporary FOFB saturation.

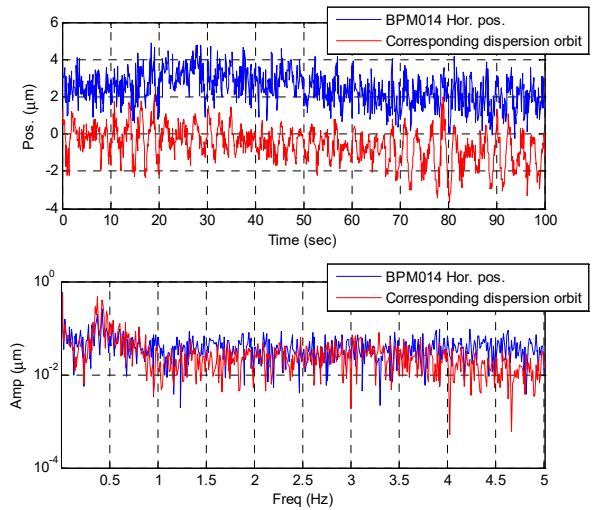

Figure 4: The upper plot shows horizontal position readings from BPM014 and a corresponding dispersion-like orbit change at 10 Hz while the lower plot shows their spectra.

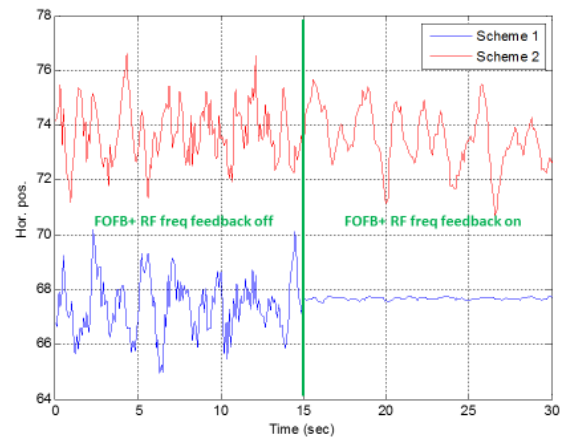

Figure 5: Comparison of Schemes 1 and 2 for RF frequency correction.

OBSERVATION OF ORBIT STABILITY DURING PATH LENGTH COMPENSATION

Without FOFB and RF path length compensation, the horizontal orbit drift during one day can be up to one hundred micron as shown in the blue line of Fig. 6. When applying FOFB, it can correct some part of this orbit drift due to the circumference change, but there is still a residual error with respect to the golden orbit which cannot be fixed by FOFB and can be up to 20 μm in high dispersion areas. However, with RF path length compensation, the orbit stability can be controlled below the submicron level as shown in Fig. 6 (black line).

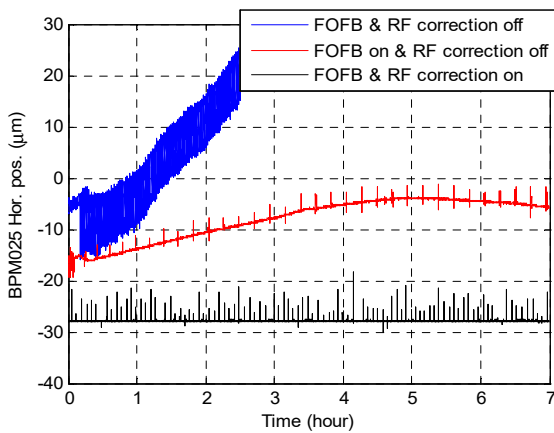

Figure 6: Orbit stability comparison with/without FOFB and RF path length compensation. The spikes are due to regular injection when FOFB and RF frequency correction is temporarily inactive.

OBSERVATION OF RF FREQUENCY VARIATION DUE TO PATH LENGTH CHANGE

From archived data of RF frequency, it can be observed that the circumference of the electron orbit is affected by day to day temperature variations in addition to seasonal influences. There is also a small semi-diurnal RF frequency variation due to earth/ocean tidal effects as shown in Fig 7.

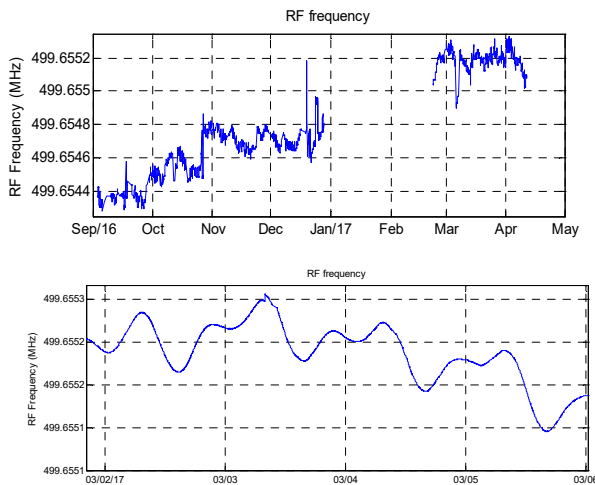

Figure 7: The upper plot is the RF frequency variation from September 2016 to April 2017 and the lower plot shows a more detailed observation for four days. RF variation per day is around 100 Hz, equal to path length about 100 μm .

For more details, in Fig. 8 the earth/ocean tides, the local temperature at the NSRRC site and the RF frequency are shown together in red/green, blue and black lines, respectively. It can be inferred that the circumference of the electron orbit is affected by the temperature and the ocean/earth tides as reflected by the simultaneous change of the RF frequency while correcting the orbit. The phase lag observed between the

temperature, tides and RF variations will be further studied in the future.

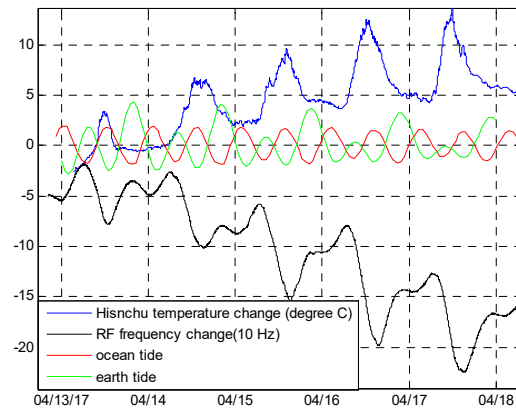

Figure 8: The black line is the RF frequency change while applying RF frequency corrections. The blue line is the ambient temperature on the NSRRC site. The red line is the ocean tide at the seashore about 15 km west of the TPS site provided by Central Weather Bureau of Taiwan [4] and the earth tides in green are calculated from the Program *solid* [5].

CONCLUSION

Closed orbit correction by the FOFB combined with RF frequency correction to compensate for path length variations is quite beneficial. There are two methods for RF frequency correction considered and introduced in this report. Both methods have been applied in the TPS storage ring. Scheme 1 shows better results when long-term drifts are corrected by RF frequency adjustments and short-term transient variations are compensated by the FOFB. As a result, orbit variations can be kept below one micron during routine TPS operations.

REFERENCE

- [1] TPS Design Handbook, version 16, June 2009.
- [2] Pei-Chen Chiu *et al.*, “Fast Orbit Scheme and Implementation for TPS”, in *Proc. IPAC’13*, Shanghai, China, 2013.
- [3] C. H. Kuo *et al.*, “The Design Strategy of Orbit Feedback System in the TPS”, in *Proc. IBIC’13*, Oxford, UK, 2013.
- [4] <http://www.cwb.gov.tw/>
- [5] <http://geodesyworld.github.io/SOFTS/solid.htm#link2>